



*Labglas*



***Labglas***  
***Scientific Equipments***

**Vijay Chauhan**  
Production Supervisor  
8081111155



ISO 9001 : 2015

**Sachin Chauhan**  
Marketing Supervisor  
9802888828

## ***Labglas Scientific Equipments***

**GSTIN : 06AXOPC6505B1ZW**

**Website : [www.Labglassscientific.com](http://www.Labglassscientific.com)**

**E-mail : [Labglas22@gmail.com](mailto:Labglas22@gmail.com), [Labglass22@gmail.com](mailto:Labglass22@gmail.com)**

**Manufacturers of LGSE Srano Glassware and Equipments which are fabricated from Borosilicate / Borosil Glass according to standard specification. ISO 9001 : 2015**

*Dear Customer,*

*The Glassware items gusted in this Catalogue are the Usual standard equipments required in any modern Laboratory. However we are in a position to manufacture or supply any other of Laboratory Glassware equipments as per design/demand of the customers. ACC enquires for research apparatus are dealt with promptly.*

*Our mission is to emerge as a preferred vendor for laboratory glassware in the domestic as well as international markets. We would also develop a comlimentry range of laboratory consumable in our product portfolio*

*Labglas believes in delivering world class quality to all its clients globally and is recognized in international market for a quality brand.*

*I take this opportunity to wish all of you the very best for the year ahead.*

With kind regards.

---

**Labglas Scientific Equipments**

**Corporate office : 7/51, Nirmal Bhawan, Sarsehari Road, Ambala Cantt. (Haryana) 133001, INDIA**

**Off. Phone : 0171-2893828**

## TERMS & CONDITIONS

### **Prices :**

All the prices in the list are Ex-works Ambala and subject to market fluctuation and alteration without notice.

### **Sales Tax Octroi :**

Sales Tax, Octroi and other levis if any as and when and where ever applicable, as per Central/Stat Govt. rules will be charged extra.

### **Insurance :**

Insurance for outward condition may be made by the buyer for safe handling of the goods.

### **Orders :**

All order must accompany with full instructions for despatch, viz. the name and address of the bank through which GR/RR is to be sent, Sales Tax to be charged and 'C' Form and instructions for insurance. Please always mention our Catalogue Number with brief description while placing your esteemed order.

### **Packing & Forwarding :**

Packing, Forwarding, Freight, Insurance and Other Incidental Charges extra.

### **Delivery :**

Where ever possible we shall effect immediate delivery, otherwise 4-8 weeks time will be required to execute the order. In Case of unavoidable Circumstances, company is not bound to execute the order.

### **Breakage / Damages :**

Every possible care is taken in packing. The company is not liable for any breakage shortage and damage in transit. All the goods are supplied at purchaser's risk.

### **Paymets :**

GR / RR and our bill will be sent through any scheduled bank or by VPP New customers are humbly requested to send draft for 25% amount of the estimated value of order as an advance.

### **Specification :**

All descriptions, pictures / illustrations etc. are intended to convey a general description of the goods offered. However, due to our policy to improve goods whenever possible, specifications are subject to alterations without prior notice, and we accept no responsibility for any loss caused by such alterations having been made, provided product is of comparable quality. **ISO 9001 : 2015**

### **Disputes :**

All disputes are subject to Ambala Jurisdiction.

## CONTENTS

S.NO.	DESCRIPTION	PAGE NO.
1.	<b>Volumetric / Graduated</b> (viz. Burettes, Pipettes, Volumetric Flasks, Cylinders etc.)	1 – 14
2.	<b>General Glassware</b> (viz. Tubes, Beakers, Bottles, Flasks etc.)	14 – 34
3.	<b>Standard Joint Components</b> (viz. Condensers, Stoppers, Adapters, Heads, Traps etc.)	34 – 43
4.	<b>Separating / Dropping Funnels</b> (viz. Pear, Globe, Pressure Equalizing etc.)	43 – 46
5.	<b>Assemblies, Extractors &amp; Distillations</b> (viz. Distillations, Soxhlet, Stills etc.)	47 – 48
6.	<b>Sintered Glassware</b> (viz. Crucibles, Buchher Funnels, Filtration, Membrane Holders etc.)	49 – 50
7.	<b>Misc. Glassware</b> (viz. Stopcocks, Clinical, Gas etc.)	51 – 55
8.	<b>Miscellaneous Glassware</b>	56 – 57

### BURETTES

#### 1.1 Burettes "Labglas", with Straight Bore Glass Key Stopcock. Accuracy as per Class 'A'

Cat. No.	Capacity (ml)	Sub. Div. (ml)	Tolerance ( $\pm$ ml)	Price / Piece (Rs.)
1.1	10	0.05	0.02	540.00
1.2	10	0.02	0.02	610.00
1.3	25	0.1	0.05	470.00
1.4	25	0.05	0.03	585.00
1.5	50	0.1	0.05	505.00
1.6	100	0.2	0.1	520.00

#### 2.1 Burettes "Labglas", Amber, with Straight Bore Glass Key Stopcock. Accuracy as per Class 'A'

Cat. No.	Capacity (ml)	Sub. Div. (ml)	Tolerance ( $\pm$ ml)	Price / Piece (Rs.)
2.1	10	0.05	0.02	765.00
2.2	25	0.1	0.05	783.00
2.3	50	0.1	0.05	837.00
2.4	100	0.2	0.1	855.00

#### 3.1 Burettes "Labglas", with Straight Bore Glass Key Stopcock. Accuracy as per Class 'B'

Cat. No.	Capacity (ml)	Sub. Div. (ml)	Tolerance ( $\pm$ ml)	Price / Piece (Rs.)
3.1	10	0.05	0.05	270.00
3.2	10	0.02	0.03	338.00
3.3	25	0.1	0.1	185.00
3.4	25	0.05	0.05	270.00
3.5	50	0.1	0.1	189.00
3.6	100	0.2	0.2	265.00

#### 4.1 Burettes "Labglas", with Screw Type PTFE Needle Value Stopcock. Accuracy as per Class 'A'

Cat. No.	Capacity (ml)	Sub. Div. (ml)	Tolerance ( $\pm$ ml)	Price / Piece (Rs.)
4.1	10	0.05	0.02	540.00
4.2	10	0.02	0.02	612.00
4.3	25	0.1	0.05	473.00
4.4	25	0.05	0.03	567.00
4.5	50	0.1	0.05	505.00
4.6	100	0.2	0.1	520.00

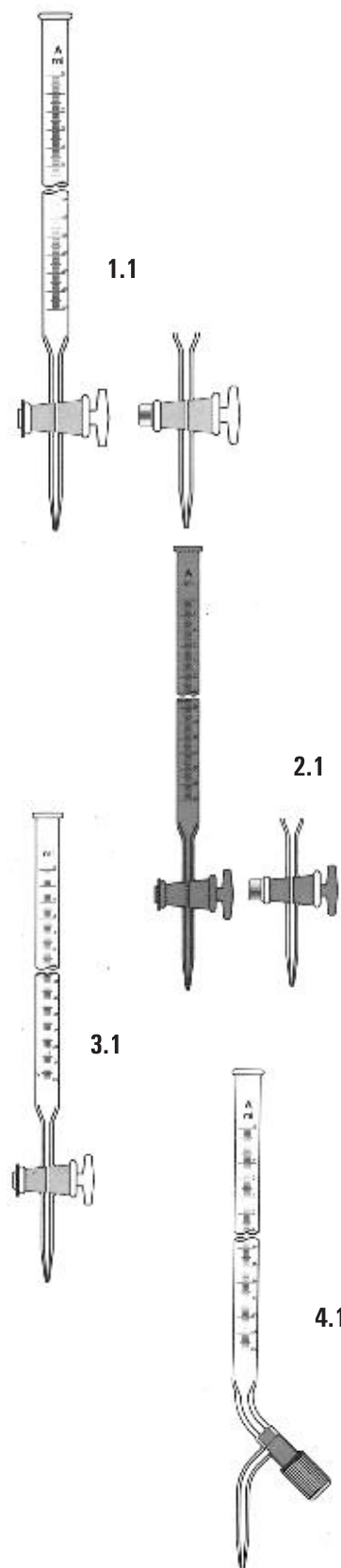

**5.1 Burettes "Labglas", Amber with Screw Type PTFE Needle Valve Stopcock. Accuracy as per Class 'A' ISO 9001:2015**

Cat. No.	Capacity (ml)	Sub. Div. (ml)	Tolerance ( $\pm$ ml)	Price / Piece (Rs.)
5.1	10	0.05	0.02	765.00
5.2	25	0.1	0.05	783.00
5.3	50	0.1	0.05	837.00
5.4	100	0.2	0.1	855.00

**6.1 Burettes "Labglas", with Screw Type PTFE Needle Valve Stopcock. Accuracy as per Class 'B'**

Cat. No.	Capacity (ml)	Sub. Div. (ml)	Tolerance ( $\pm$ ml)	Price / Piece (Rs.)
6.1	10	0.05	0.05	248.00
6.2	10	0.02	0.03	337.00
6.3	25	0.1	0.1	185.00
6.4	25	0.05	0.05	270.00
6.5	50	0.1	0.1	189.00
6.6	100	0.2	0.2	265.00

**7.1 Burettes "Labglas", with Straight Bore PTFE Key Stopcock. Accuracy as per Class 'A'**

Cat. No.	Capacity (ml)	Sub. Div. (ml)	Tolerance ( $\pm$ ml)	Price / Piece (Rs.)
8.1	10	0.02	0.02	720.00
8.2	10	0.05	0.02	810.00
8.3	25	0.1	0.05	684.00
8.4	25	0.05	0.03	738.00
8.5	50	0.1	0.05	697.00
8.6	100	0.2	0.1	715.00

**8.1 Burettes "Labglas", Amber with Straight Bore PTFE Key Stopcock. Accuracy as per Class 'A'**

Cat. No.	Capacity (ml)	Sub. Div. (ml)	Tolerance ( $\pm$ ml)	Price / Piece (Rs.)
8.1	10	0.05	0.02	945.00
8.2	25	0.1	0.05	972.00
8.3	50	0.1	0.05	1026.00
8.4	100	0.2	0.1	1125.00

**9.1 Burettes "Labglas", with Straight Bore PTFE Key Stopcock. Accuracy as per Class 'B'**

Cat. No.	Capacity (ml)	Sub. Div. (ml)	Tolerance ( $\pm$ ml)	Price / Piece (Rs.)
9.1	10	0.05	0.05	450.00
9.2	25	0.1	0.1	387.00
9.3	50	0.1	0.1	414.00
9.4	100	0.2	0.2	495.00

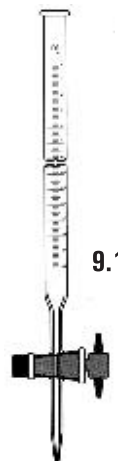
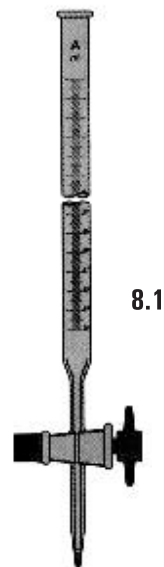
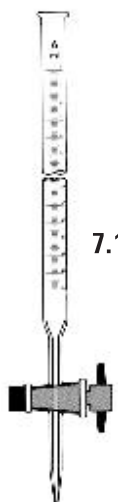
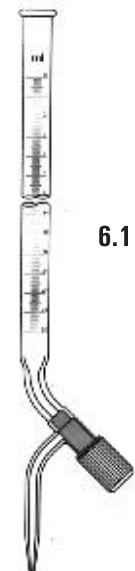
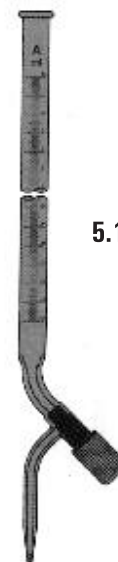

## Volumetric / Graduated Glassware

### 10.1 Burettes "Labglas", Automatic Zero, with Glass Key Stopcock, Mounted on Reservoir, Rubber bellow, Accuracy as per Class 'A'

Cat. No.	Capacity (ml)	Sub. Div. (ml)	Tolerance ( $\pm$ ml)	Price / Piece (Rs.)
10.1	10	0.05	0.02	3150.00
10.2	25	0.1	0.05	3848.00
10.3	50	0.1	0.05	3933.00
10.4	100	0.2	0.1	4185.00

### 11.1 Burettes "Labglas", Amber, Automatic Zero, with Glass Key Stopcock, mounted on Reservoir, Rubber below, Accuracy as per Class 'A'

Cat. No.	Capacity (ml)	Sub. Div. (ml)	Tolerance ( $\pm$ ml)	Price / Piece (Rs.)
11.1	10	0.05	0.02	3983.00
11.2	25	0.1	0.05	4770.00
11.3	50	0.1	0.05	4860.00
11.4	100	0.2	0.1	5130.00

### 12.1 Burettes "Labglas", Automatic Zero, with Screw type PTFE Needle Valve Stopcock, mounted on Reservoir, Rubber below, Accuracy as per Class 'A'

Cat. No.	Capacity (ml)	Sub. Div. (ml)	Tolerance ( $\pm$ ml)	Price / Piece (Rs.)
12.1	10	0.05	0.02	3150.00
12.2	25	0.1	0.05	3848.00
12.3	50	0.1	0.05	3915.00
12.4	100	0.2	0.1	4185.00

### 13.1 Burettes "Labglas", Amber, Automatic Zero, with Screw type PTFE Needle Valve Stopcock, mounted on Reservoir, Rubber bellow, Accuracy as per Class 'A'

Cat. No.	Capacity (ml)	Sub. Div. (ml)	Tolerance ( $\pm$ ml)	Price / Piece (Rs.)
13.1	10	0.05	0.02	3983.00
13.2	25	0.1	0.05	4770.00
13.3	50	0.1	0.05	4860.00
13.4	100	0.2	0.1	5130.00

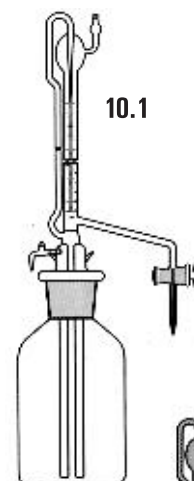

10.1

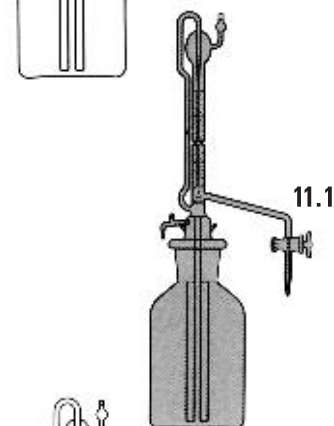

11.1

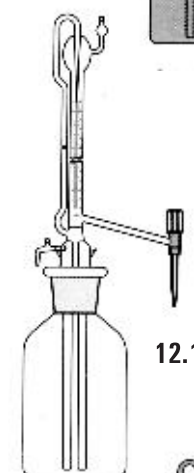

12.1

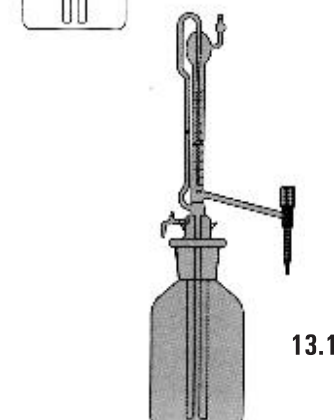

13.1

**14.1 Burettes "Labglas", Automatic Zero, with PTFE Key Stopcock, mounted on Reservoir, Rubber bellow, Accuracy as per Class 'A'**

Cat. No.	Capacity (ml)	Sub. Div. (ml)	Tolerance ( $\pm$ ml)	Price / Piece (Rs.)
14.1	10	0.05	0.02	3330.00
14.2	25	0.1	0.05	4005.00
14.3	50	0.1	0.05	4005.00
14.4	100	0.2	0.1	4365.00

**15.1 Burettes "Labglas", Amber, Automatic Zero, with PTFE Key Stopcock, mounted on Reservoir bellow, Accuracy as per Class 'A'**

Cat. No.	Capacity (ml)	Sub. Div. (ml)	Tolerance ( $\pm$ ml)	Price / Piece (Rs.)
15.1	10	0.05	0.02	4050.00
15.2	25	0.1	0.05	4860.00
15.3	50	0.1	0.05	4950.00
15.4	100	0.2	0.1	5220.00

**16.1 Burettes "Labglas", with Pinch Cock Rubber tubing and glass jet. Accuracy as per Class 'B'**

Cat. No.	Capacity (ml)	Sub. Div. (ml)	Tolerance ( $\pm$ ml)	Price / Piece (Rs.)
16.1	10	0.05	0.05	110.00
16.2	25	0.1	0.1	95.00
16.3	50	0.1	0.1	110.00

**17.1 Burettes, Automatic Zero with PTFE Key Stopcock, for Karl Fisher "Labglas", Class 'A'**

Cat. No.	Capacity (ml)	Sub. Div. (ml)	Tolerance ( $\pm$ ml)	Price / Piece (Rs.)
17.1	10	0.05	0.02	3330.00
17.2	25	0.1	0.05	3960.00

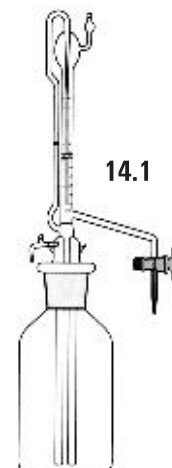

14.1

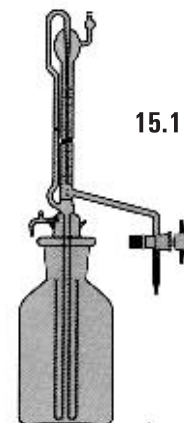

15.1



16.1

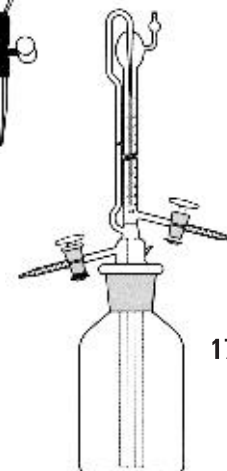

17.1



### PIPETTES

#### 18.1 Pipettes Transfer Volumetric, "Labglas" accuracy as per Class 'A'

Cat. No.	Capacity (ml)	Tolerance ( $\pm$ ml)	Price / Piece (Rs.)
18.1	1	0.006	120.00
18.2	2	0.006	120.00
18.3	3	0.01	120.00
18.4	4	0.01	120.00
18.5	5	0.01	125.00
18.6	6	0.01	130.00
18.7	7	0.01	130.00
18.8	8	0.02	145.00
18.9	9	0.02	145.00
18.10	10	0.02	145.00
18.11	15	0.03	155.00
18.12	20	0.03	165.00
18.13	25	0.03	165.00
18.14	30	0.03	190.00
18.15	40	0.05	260.00
18.16	50	0.05	270.00
18.17	100	0.08	310.00



18.1

#### 19.1 Pipettes Transfer, Volumetric, "Labglas", one mark, Accuracy as per Class 'A'

Cat. No.	Capacity (ml)	Tolerance ( $\pm$ ml)	Price / Piece (Rs.)
19.1	1	0.006	110.00
19.2	2	0.01	110.00
19.3	3	0.01	110.00
19.4	4	0.01	110.00
19.5	5	0.015	110.00
19.6	6	0.015	110.00
19.7	7	0.015	110.00
19.8	8	0.015	110.00
19.9	9	0.02	110.00
19.10	10	0.02	110.00
19.11	15	0.02	135.00
19.12	20	0.03	135.00
19.13	25	0.03	135.00
19.14	50	0.05	185.00
19.15	100	0.08	265.00

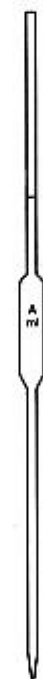

19.1

**20.1 Pipettes Transfer, Volumetric, "Labglas", one mark. Accuracy as per Class 'B'**

Cat. No.	Capacity (ml)	Tolerance ( $\pm$ ml)	Price / Piece (Rs.)
20.1	1	0.015	65.00
20.2	2	0.02	66.00
20.3	5	0.03	60.00
20.4	10	0.04	70.00
20.5	20	0.06	77.00
20.6	25	0.06	77.00
20.7	50	0.1	118.00
20.8	100	1.16	165.00



20.1

**21.1 Pipettes, Measuring, Graduated, Serological, "Labglas". Accuracy as per Class 'A'**  
(These pipettes are calibrated to deliver from any graduation line down to zero at the jet, with the last drop expelled by blowing). These pipettes are graduated to tip (machine made) and deliver their total capacity when last drop is blown out.

Cat. No.	Capacity (ml)	Sub. Div. (ml)	Tolerance ( $\pm$ ml)	Price / Piece (Rs.)
21.1	0.1	0.01	0.006	135.00
21.2	0.2	0.01	0.006	135.00
21.3	0.5	0.02	0.006	135.00
21.4	1	0.01	0.006	135.00
21.5	1	0.1	0.006	135.00
21.6	2	0.02	0.01	135.00
21.7	2	0.1	0.01	135.00
21.8	5	0.05	0.03	135.00
21.9	5	0.1	0.05	135.00
21.10	10	0.1	0.05	135.00
21.11	25	0.2	0.1	180.00

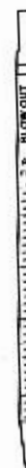

21.1

**22.1 Pipettes, Measuring, Graduated, Serological, "Labglas". Accuracy as per Class 'B'**  
(These Pipettes are calibrated to deliver from any graduation line down to zero at the jet, with the last drop expelled by blowing). These pipettes are graduated to tip (machine made) and deliver their total capacity when last drop is blown out.

Cat. No.	Capacity (ml)	Sub. Div. (ml)	Tolerance ( $\pm$ ml)	Price / Piece (Rs.)
22.1	0.1	0.01	0.01	75.00
22.2	0.2	0.01	0.01	75.00
22.3	0.5	0.02	0.01	75.00
22.4	1	0.01	0.01	68.00
22.5	1	0.1	0.01	75.00
22.6	2	0.02	0.02	68.00
22.7	2	0.1	0.02	75.00
22.8	5	0.05	0.05	70.00
22.9	5	0.1	0.1	75.00
22.10	10	0.1	0.1	70.00
22.11	25	0.2	0.2	95.00

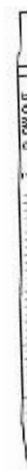

22.1

## Volumetric / Graduated Glassware

**23.1** Pipettes, Measuring, Graduated, Mohr type, "Labglas". Accuracy as per Class 'A' (These pipettes are graduated for the delivery from zero mark at top to the last graduation mark.) Pipette tips are machine made.

Cat. No.	Capacity (ml)	Sub. Div. (ml)	Tolerance ( $\pm$ ml)	Price / Piece (Rs.)
23.1	0.1	0.01	0.006	135.00
23.2	0.2	0.01	0.006	135.00
23.3	0.5	0.02	0.006	135.00
23.4	1	0.01	0.006	135.00
23.5	1	0.1	0.006	135.00
23.6	2	0.02	0.01	135.00
23.7	2	0.1	0.01	135.00
23.8	5	0.05	0.03	135.00
23.9	5	0.1	0.05	135.00
23.10	10	0.1	0.05	135.00
23.11	25	0.2	0.1	180.00



23.1

**24.1** Pipettes, Measuring, Graduated, Mohr type, "Labglas". Accuracy as per Class 'B' (These pipettes are graduated for delivery from zero mark at top to the last graduation mark.) Pipette tips are machine made.

Cat. No.	Capacity (ml)	Sub. Div. (ml)	Tolerance ( $\pm$ ml)	Price / Piece (Rs.)
24.1	0.1	0.01	0.01	75.00
24.2	0.2	0.01	0.01	75.00
24.3	0.5	0.02	0.01	75.00
24.4	1	0.01	0.01	68.00
24.5	1	0.1	0.01	75.00
24.6	2	0.02	0.02	68.00
24.7	2	0.1	0.02	75.00
24.8	5	0.05	0.05	70.00
24.9	5	0.1	0.1	75.00
24.10	10	0.1	0.1	70.00
24.11	25	0.2	0.2	95.00



24.1

**25.1** Pipettes Automatic "Labglas" Quick acting for rapid work of approximate accuracy (Tilt Measure) complete with Conical Flask, Interchangeable joint fitting.

Cat. No.	Capacity (ml)	Reservoir Capacity (ml)	Price / Piece (Rs.)
25.1	1	100	375.00
25.2	2	100	375.00
25.3	5	250	400.00
25.4	10	250	400.00
25.5	20	500	460.00
25.6	25	500	460.00

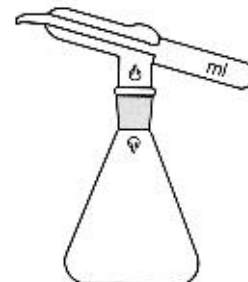

25.1

## Volumetric / Graduated Glassware

26.1 Pipette for Milk Test "Labglas", Bacteriological, Graduated as per is Specifications No. 2025 : 1962.

Cat. No.	Capacity (ml)	Sub. Div. (ml)	Tolerance ( $\pm$ ml)	Price / Piece (Rs.)
26.1	1.1	0.5, 1 & 1.1	0.025	90.00
26.2	2.2	1.0, 2.0, 2.1 & 2.2	0.04	100.00

27.1 Pipette E.S.R. "Labglas" 200 mm. graduation, 300 mm long 29.00

28.1 Pipette, Pasteur, Disposable, Neutral Borosilicate Glass.

Cat. No.	Length approx. (mm)	Qty. / Pack	Price / Pack (Rs.)
0.1.071.01	Length 145 mm	100	540.00
01.071.03	Length 230 mm	100	630.00

## VOLUMETRIC FLASK

29.1 Flask Volumetric, "Labglas" with Interchangeable Stopper, Accuracy as per 'ASTME-288 Class 'A'

Cat. No.	Capacity (ml)	Tolerance ( $\pm$ ml)	Stopper Size	Price / Piece (Rs.)
29.1	5	0.02	10/19	340.00.
29.2	10	0.02	10/19	350.00
29.3	20	0.03	10/19	330.00
29.4	25	0.03	10/19	330.00
29.5	50	0.05	10/19	340.00
29.6	100	0.08	14/23	350.00
29.7	200	0.1	14/23	425.00
29.8	250	0.12	14/23	425.00
29.9	500	0.2	19/26	685.00
29.10	1000	0.3	19/26	830.00
29.11	2000	0.5	24/29	1890.00

30.1 Flasks, Volumetric, "Labglas", Amber with I/C Stopper Accuracy as per ASTM E-288, Class 'A'

Cat. No.	Capacity (ml)	Tolerance ( $\pm$ ml)	Stopper Size	Price / Piece (Rs.)
30.1	5	0.02	10/19	495.00
30.2	10	0.02	10/19	505.00
30.3	20	0.03	10/19	510.00
30.4	25	0.03	10/19	510.00
30.5	50	0.05	10/19	535.00
30.6	100	0.08	14/23	565.00
30.7	200	0.1	14/23	765.00
30.8	250	0.12	14/23	765.00
30.9	500	0.2	19/26	1155.00
30.10	1000	0.3	19/26	1485.00
30.11	2000	0.5	24/29	2565.00

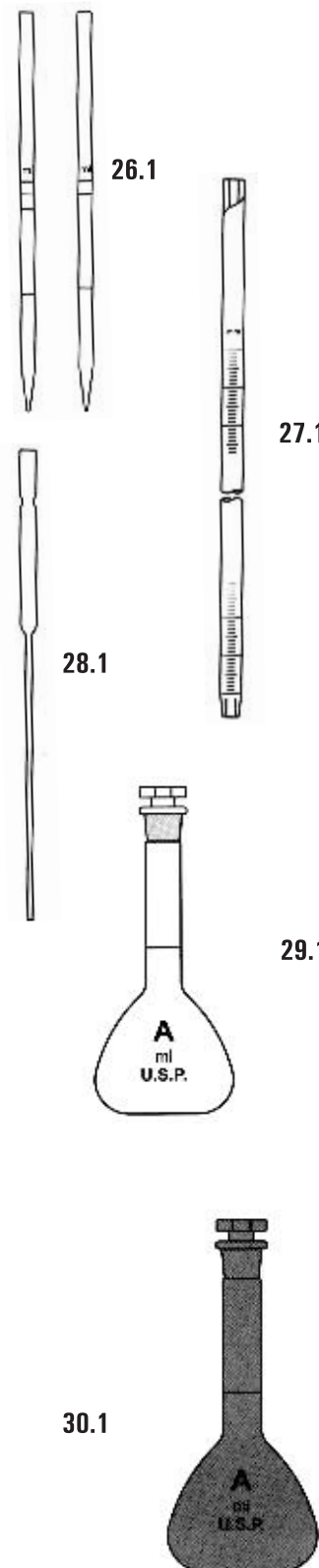

## Volumetric / Graduated Glassware

### 31.1 Flasks, Volumetric, "Labglas" with interchangeable stopper, Accuracy as per Class 'A'

Cat. No.	Capacity (ml)	Tolerance ( $\pm$ ml)	Stopper Size	Price / Piece (Rs.)
31.1	*1	0.015	10/19	135.00
31.2	*2	0.015	10/19	135.00
31.3	4	0.02	10/19	225.00
31.4	5	0.025	10/19	140.00
31.5	10	0.025	10/19	150.00
31.6	20	0.04	10/19	160.00
31.7	25	0.04	10/19	160.00
31.8	40	0.06	10/19	270.00
31.9	50	0.06	10/19	175.00
31.10	75	0.06	10/19	310.00
31.11	100	0.1	14/23	225.00
31.12	150	0.1	14/23	350.00
31.13	200	0.15	14/23	315.00
31.14	250	0.15	14/23	315.00
31.15	500	0.25	19/26	525.00
31.16	900	0.1	19/26	810.00
31.17	1000	0.4	19/26	765.00
31.18	2000	0.6	24/29	1565.00
31.19	5000	1.2	34/35	8010.00

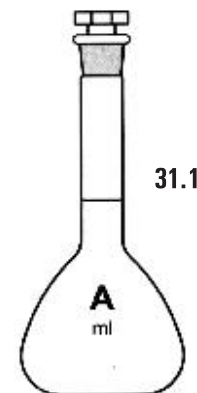

31.1

### 32.1 Flask, Volumetric "Labglas" Wide Mouth, Class 'A' with interchangeable stopper

Cat. No.	Capacity (ml)	Tolerance ( $\pm$ ml)	Stopper Size	Price / Piece (Rs.)
32.1	25	0.04	14/23	255.00
32.2	50	0.6	14/23	280.00
32.3	100	0.1	19/26	330.00
32.4	200	0.15	19/26	390.00

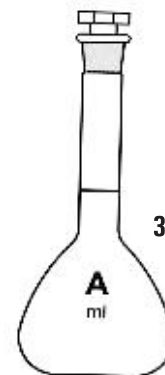

32.1

### 33.1 Flask Volumetric, "Labglas", Amber, with interchangeable stopper, accuracy as per Class 'A'

Cat. No.	Capacity (ml)	Tolerance ( $\pm$ ml)	Stopper Size	Price / Piece (Rs.)
33.1	*1	0.015	10/19	205.00
33.2	*2	0.015	10/19	205.00
33.3	5	0.025	10/19	215.00
33.4	10	0.025	10/19	220.00
33.5	20	0.04	10/19	255.00
33.6	25	0.04	10/19	255.00
33.7	50	0.06	10/19	290.00
33.8	100	0.1	14/23	345.00
33.9	200	0.15	14/23	470.00
33.10	250	0.15	14/23	470.00
33.11	500	0.25	19/26	800.00
33.12	1000	0.4	19/26	1215.00
33.13	2000	0.6	24/29	2385.00
33.14	5000	1.2	34/35	9450.00

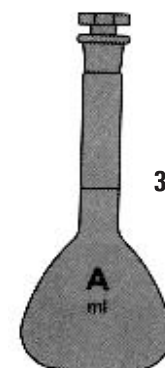

33.1

### 34.1 Flask Volumetric "Labglas" with interchangeable stopper, accuracy as per Class 'B'

Cat. No.	Capacity (ml)	Tolerance ( $\pm$ ml)	Stopper Size	Price / Piece (Rs.)
34.1	*1	0.03	10/19	60.00
34.2	*2	0.03	10/19	60.00
34.3	5	0.05	10/19	65.00
34.4	10	0.05	10/19	70.00
34.5	20	0.08	10/19	85.00
34.6	25	0.08	10/19	85.00
34.7	50	0.12	10/19	110.00
34.8	100	0.2	14/23	130.00
34.9	200	0.3	14/23	170.00
34.10	250	0.3	14/23	170.00
34.11	500	0.5	19/26	280.00
34.12	1000	0.8	19/26	445.00
34.13	2000	1.2	24/29	935.00
34.14	5000	2.5	34/35	530.00

\*1 ml. and 2 ml. Volumetric Flasks are of Test Tube shape.

### 35.1 Flasks Volumetric "Labglas" Sugar estimation with two marks without stopper Accuracy as per B.S. 675 : 1953

Cat. No.	Capacity (ml)	Price / Piece (Rs.)
35.1	Marked at 50 ml and 55 ml	135.00
35.2	Marked at 100 ml and 110 ml	170.00
35.3	Marked at 200 ml and 220 ml	215.00

### 36.1 Flask "Labglas" Sugar estimation, Class 'A'

Cat. No.	Capacity (ml)	Price / Piece (Rs.)
36.1	50-55	220.00
36.2	100-110	270.00
36.3	200-220	325.00

### 37.1 Kohlraush Flasks (Mud Flask) "Labglas" with cup at top.

Cat. No.	Capacity (ml)	Tolerance ( $\pm$ ml)	Price / Piece (Rs.)
37.1	50	0.04	155.00
37.2	100	0.06	185.00
37.3	200	0.1	245.00

### 38.1 Kohlraush Flasks (Mud Flask) "Labglas" with cup at top, Class 'A'

Cat. No.	Capacity (ml)	Price / Piece (Rs.)
38.1	50-55	245.00
38.2	100-110	270.00
38.3	200-220	345.00

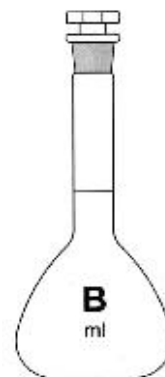

34.1

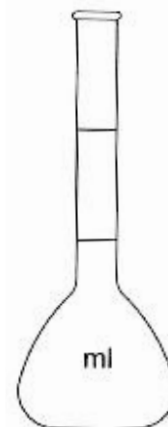

35.1 & 36.1



37.1 & 38.1

39.1 Lechatelier Flask, "Labglas" for Sp. Gr. Test 250 ml,  
Neck graduation from 0 to 1 ml. and 18 to 24 ml in 0.1 ml 890.00

40.1 Lechatelier Flask, "Labglas" for Sp. Gr. Test 250 ml,  
Neck graduation from 0 to 1 ml and 18 to 24 ml in 0.1 ml.  
Accuracy as per Class 'A' 1315.00



39.1

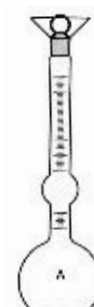

40.1

### MEASURING CYLINDERS

41.1 Measuring Cylinders "Labglas", Accuracy as per ASTM E1272 Class 'A'

Cat. No.	Capacity (ml)	Sub. Div. (ml)	Tolerance ( $\pm$ ml)	Price / Piece (Rs.)
41.1	5	0.1	0.05	235.00
41.2	10	0.2	0.1	260.00
41.3	25	0.5	0.17	310.00
41.4	50	1	0.25	385.00
41.5	100	1	0.5	430.00
41.6	250	2	1	650.00
41.7	500	5	2	990.00
41.8	1000	10	3	1145.00
41.9	2000	20	6	1870.00



41.1

42.1 Measuring Cylinders, "Labglas" with spout, Hexagonal Base, Class 'A'

Cat. No.	Capacity (ml)	Sub. Div. (ml)	Tolerance ( $\pm$ ml)	Price / Piece (Rs.)
42.1	5	0.1	0.05	225.00
42.2	10	0.2	0.1	235.00
42.3	25	0.5	0.25	268.00
42.4	50	1	0.5	335.00
42.5	100	1	0.5	395.00
42.6	250	2	1	610.00
42.7	500	5	2.5	850.00
42.8	1000	10	5	1035.00
42.9	2000	20	10	1735.00



42.1

43.1 Measuring Cylinders, "Labglas", Amber with spout, Hexagonal Base, Class 'A'

Cat. No.	Capacity (ml)	Sub. Div. (ml)	Tolerance ( $\pm$ ml)	Price / Piece (Rs.)
43.1	5	0.1	0.05	305.00
43.2	10	0.2	0.1	335.00
43.3	25	0.5	0.25	385.00
43.4	50	1	0.5	420.00
43.5	100	1	0.5	570.00
43.6	250	2	1	810.00
43.7	500	5	2.5	1195.00
43.8	1000	10	5	1565.00
43.9	2000	20	10	2700.00



43.1

### 44.1 Measuring Cylinders "Labglas", with spout, Hexagonal Base, Thick Wall, Accuracy as per Class 'B'

Cat. No.	Capacity (ml)	Sub. Div. (ml)	Tolerance ( $\pm$ ml)	Price / Piece (Rs.)
44.1	5	0.1	0.1	145.00
44.2	10	0.2	0.2	150.00
44.3	25	0.5	0.5	170.00
44.4	50	1	1	185.00
44.5	100	1	1	215.00
44.6	250	2	2	395.00
44.7	500	5	5	465.00
44.8	1000	10	10	810.00
44.9	2000	20	20	1500.00



44.1

### 45.1 Measuring Cylinders "Labglas", with interchangeable stopper, Hexagonal Base, Class 'A'

Cat. No.	Capacity (ml)	Sub. Div. (ml)	Tolerance ( $\pm$ ml)	Price / Piece (Rs.)
45.1	5	0.1	0.05	295.00
45.2	10	0.2	0.1	300.00
45.3	25	0.5	0.25	325.00
45.4	50	1	0.5	435.00
45.5	100	1	0.5	510.00
45.6	250	2	1	885.00
45.7	500	5	2.5	1365.00
45.8	1000	10	5	1590.00
45.9	2000	20	10	2525.00

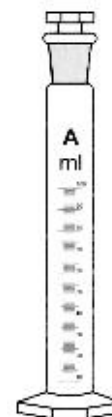

45.1

### 46.1 Measuring Cylinders, "Labglas", Amber, with interchangeable stopper Hexagonal Base, Class 'A'

Cat. No.	Capacity (ml)	Sub. Div. (ml)	Tolerance ( $\pm$ ml)	Price / Piece (Rs.)
46.1	5	0.1	0.05	340.00
46.2	10	0.2	0.1	360.00
46.3	25	0.5	0.25	390.00
46.4	50	1	0.5	465.00
46.5	100	1	0.5	555.00
46.6	250	2	1	810.00
46.7	500	5	2.5	1325.00
46.8	1000	10	5	1925.00
46.9	2000	20	10	2900.00



46.1



**47.1 Measuring Cylinders, "Labglas", with interchangeable stopper, Hexagonal Base, Accuracy as per Class 'B'**

Cat. No.	Capacity (ml)	Sub. Div. (ml)	Tolerance ( $\pm$ ml)	Price / Piece (Rs.)
47.1	5	0.1	0.1	210.00
47.2	10	0.2	0.2	215.00
47.3	25	0.5	0.5	220.00
47.4	50	1	1	255.00
47.5	100	1	1	310.00
47.6	250	2	2	575.00
47.7	500	5	5	775.00
47.8	1000	10	10	1190.00
47.9	2000	20	20	1780.00

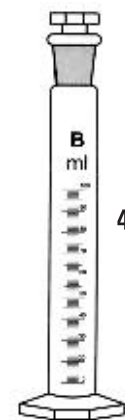

47.1

**48.1 Measuring Cylinders "Labglas", with spout, Round Base, Class 'A'**

Cat. No.	Capacity (ml)	Sub. Div. (ml)	Tolerance ( $\pm$ ml)	Price / Piece (Rs.)
48.1	5	0.1	0.05	125.00
48.2	10	0.2	0.1	130.00
48.3	25	0.5	0.25	145.00
48.4	50	1	0.5	215.00
48.5	100	1	0.5	285.00
48.6	250	2	1	510.00
48.7	500	5	2.5	810.00
48.8	1000	10	5	990.00
48.9	2000	20	10	1550.00



48.1

**49.1 Measuring Cylinders, "Labglas", with spout, Round Base, Thick Wall, Accuracy as per Class 'B'**

Cat. No.	Capacity (ml)	Sub. Div. (ml)	Tolerance ( $\pm$ ml)	Price / Piece (Rs.)
49.1	5	0.1	0.1	80.00
49.2	10	0.2	0.2	80.00
49.3	25	0.5	0.5	120.00
49.4	50	1	1	150.00
49.5	100	1	1	175.00
49.6	250	2	2	320.00
49.7	500	5	5	540.00
49.8	1000	10	10	810.00
49.9	2000	20	20	1350.00



49.1

### 50.1 Measuring Cylinders, "Labglas", with interchangeable stopper, Round Base, Class 'A'

Cat. No.	Capacity (ml)	Sub. Div. (ml)	Tolerance ( $\pm$ ml)	Price / Piece (Rs.)
50.1	5	0.1	0.05	175.00
50.2	10	0.2	0.1	175.00
50.3	25	0.5	0.25	235.00
50.4	50	1	0.5	290.00
50.5	100	1	0.5	345.00
50.6	250	2	1.0	600.00
50.7	500	5	2.5	1015.00
50.8	1000	10	5	1185.00
50.9	2000	20	10	1795.00

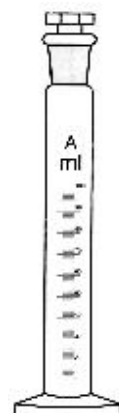

50.1

### 51.1 Measuring Cylinders, "Labglas", with interchangeable stopper, Round Base, Accuracy as per Class 'B'

Cat. No.	Capacity (ml)	Sub. Div. (ml)	Tolerance ( $\pm$ ml)	Price / Piece (Rs.)
51.1	5	0.1	0.1	130.00
51.2	10	0.2	0.2	130.00
51.3	25	0.5	0.5	175.00
51.4	50	1	1	230.00
51.5	100	1	1	270.00
51.6	250	2	2	495.00
51.7	500	5	5	710.00
51.8	1000	10	10	925.00
51.9	2000	20	20	1650.00

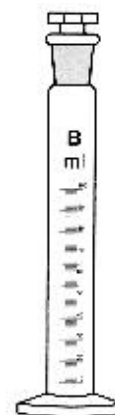

51.1

### 52.1 Nessler Cylinder, "Labglas", for colour comparison graduated as per is

Cat. No.	Capacity (ml)	Sub. Div. (ml)	Tolerance ( $\pm$ ml)	Price / Piece (Rs.)
52.1	50	25 & 50	0.4	70.00
52.2	100	50 & 100	0.8	95.00



52.1

## TUBES

### 53.1 Tubes, Culture, Media, "Labglas", Round Bottom, with Screw Cap, PTFE & Rubber liner.

Cat. No.	Capacity (ml)	O.D. x Length mm (approx)	Price / Piece (Rs.)
53.1	5	16 x 75 mm	25.00
53.2	7.5	16 x 100 mm	28.00
53.3	10	16 x 125 mm	28.00
53.4	15	16 x 150 mm	30.00
53.5	25	18 x 150 mm	35.00
53.6	30	25 x 100 mm	35.00
53.7	45	25 x 150 mm	40.00
53.8	60	25 x 200 mm	50.00
53.9	100	35 x 200 mm	115.00
53.10	150	38 x 200 mm	205.00



53.1

## Tubes

### 54.1 Tubes Culture, Media, Amber "Labglas", Round Bottom, with Screw Cap and PTFE / Rubber Liner.

Cat. No.	Capacity (ml)	O.D. x Length mm (approx)	Price / Piece (Rs.)
54.1	5	16 x 75 mm	45.00
54.2	10	16 x 125 mm	55.00
54.3	30	25 x 100 mm	75.00
54.4	45	25 x 150 mm	95.00
54.5	60	25 x 200 mm	120.00
54.6	100	32 x 200 mm	195.00
54.7	150	38 x 200 mm	290.00



54.1

### 55.1 Tubes Culture, Media, "Labglas", Round Bottom, with Screw Cap and Rubber Liner.

Cat. No.	Capacity (ml)	O.D. x Length mm (approx)	Price / Piece (Rs.)
55.1	5	16 x 75 mm	18.00
55.2	7.5	16 x 100 mm	20.00
55.3	10	16 x 125 mm	22.00
55.4	15	16 x 150 mm	25.00
55.5	25	18 x 150 mm	28.00
55.6	30	25 x 100 mm	31.00
55.7	45	25 x 150 mm	34.00
55.8	60	25 x 200 mm	37.00
55.9	100	32 x 200 mm	95.00
55.10	150	38 x 200 mm	188.00



55.1

### 56.1 Tubes Culture, Media, "Labglas", Flat Bottom, with Screw Cap, PTFE & Rubber liner.

Cat. No.	Capacity (ml)	O.D. x Length mm (approx)	Price / Piece (Rs.)
56.1	5	16 x 50 mm	25.00
56.2	7.5	16 x 95 mm	28.00
56.3	10	16 x 120 mm	30.00
56.4	15	16 x 145 mm	34.00
56.5	25	18 x 145 mm	40.00
56.6	15	25 x 57 mm	32.00
56.7	30	25 x 95 mm	40.00
56.8	40	25 x 145 mm	42.00



56.1

### 57.1 Tubes Culture, Media, "Labglas", Amber, Flat Bottom, with Screw Cap, PTFE / Rubber liner.

Cat. No.	Capacity (ml)	O.D. x Length mm (approx)	Price / Piece (Rs.)
57.1	5	16 x 50 mm	45.00
57.2	15	25 x 57 mm	60.00
57.3	30	25 x 95 mm	75.00



57.1

### 58.1 Tubes, Culture, Media, "Labglas", Flat Bottom, with Screw Cap and Rubber liner.

Cat. No.	Capacity (ml)	O.D. x Length mm (approx)	Price / Piece (Rs.)
58.1	5	16 x 50 mm	18.00
58.2	7.5	16 x 95 mm	20.00
58.3	10	16 x 120 mm	22.00
58.4	15	16 x 145 mm	25.00
58.5	25	18 x 145 mm	29.00
58.6	15	25 x 57 mm	22.00
58.7	30	25 x 95 mm	31.00
58.8	40	25 x 145 mm	34.00

### 59.1 Centrifuge Tube, "Labglas", Conical bottom, graduated.

Cat. No.	Capacity (ml)	Height x O.D. mm (approx)	Price / Piece (Rs.)
59.1	10	110 x 15	35.00
59.2	15	120 x 17	45.00
59.3	50	125 x 28	105.00
59.4	Solubility Tube 50, graduated		205.00

### 60.1 Centrifuge Tube, "Labglas", Conical bottom, plain.

Cat. No.	Capacity (ml)	Height x O.D. mm (approx)	Price / Piece (Rs.)
60.1	10	110 x 15	21.00
60.2	12	110 x 16	22.00
60.3	15	120 x 17	22.00
60.4	50	125 x 28	94.00

### 61.1 Centrifuge Tube, "Labglas", with Screw Cap, Plain.

Cat. No.	Capacity (ml)	Price / Piece (Rs.)
61.1	10	61.00
61.2	15	62.00

### 62.1 Centrifuge Tube, "Labglas", with Screw Cap, Graduated.

Cat. No.	Capacity (ml)	Price / Piece (Rs.)
62.1	10	80.00
62.2	15	85.00

### 63.1 Centrifuge Tube, "Labglas", Conical bottom, with interchangeable stopper, Graduated.

Cat. No.	Capacity (ml)	Price / Piece (Rs.)
63.1	10	80.00
63.2	15	95.00
63.3	50	185.00

### 64.1 Centrifuge Tube, "Labglas", Conical Bottom, with interchangeable stopper, Plain.

Cat. No.	Capacity (ml)	Price / Piece (Rs.)
64.1	10	68.00
64.2	15	70.00
64.3	50	155.00

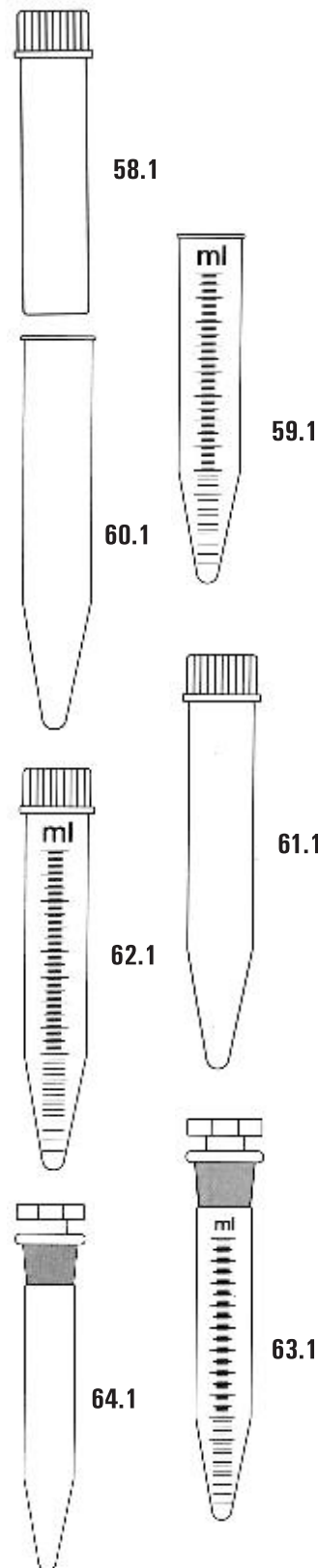

### 65.1 Test Tubes, "Labglas", with interchangeable stopper, Graduated.

Cat. No.	Length x O.D. (mm approx)	Capacity (ml)	Sub Div. (ml)	Stopper Size	Price / Piece (Rs.)
65.1	100 x 12	5	0.1	10/19	74.00
65.2	125 x 16	10	0.1	14/23	84.00
65.3	150 x 16	15	0.1	14/23	86.00
65.4	150 x 18	20	0.1	14/23	95.00
65.5	150 x 22	25	0.5	19/26	95.00
65.6	200 x 25	50	1	19/26	135.00
65.7	200 x 32	100	2	24/29	170.00

### 66.1 Test Tubes, "Labglas", with interchangeable Stopper, Plain.

Cat. No.	O.D. x Length (mm approx)	Stopper Size	Price / Piece (Rs.)
58.1	100 x 12	10/19	47.00
58.2	125 x 15	12/21	58.00
58.3	150 x 18	14/23	69.00
58.4	150 x 22	19/26	80.00
58.5	150 x 25	19/26	89.00
58.6	200 x 25	19/26	105.00
58.7	200 x 32	24/29	150.00
58.8	200 x 38	24/29	175.00

### 67.1 Test Tubes, "Labglas", Boro 33 exp. glass, Round Bottom, with rim, Plain.

Cat. No.	Capacity (ml approx)	O.D. x Length (mm approx)	Qty / Pack	Price / Piece (Rs.)
67.1	3	10 x 75	100	3.00
67.2	5	12 x 75	100	4.00
67.3	8	12 x 100	100	5.00
67.4	10	15 x 125	100	7.00
67.5	15	15 x 150	100	10.00
67.6	25	18 x 150	100	11.00
67.7	35	25 x 100	50	12.00
67.8	50	25 x 150	50	15.00
67.9	75	25 x 200	50	25.00
67.10	100	32 x 200	25	40.00
67.11	170	38 x 200	25	45.00

### 68.1 Test Tubes, "Labglas", Boro 33 exp. glass, Round Bottom, with rim, Plain.

Cat. No.	Capacity (ml approx)	O.D. x Length (mm approx)	Qty / Pack	Price / Piece (Rs.)
68.1	3	10 x 75	10	15.00
68.2	5	12 x 75	10	20.00
68.3	8	12 x 100	10	25.00
68.4	10	15 x 125	10	25.00
68.5	25	18 x 150	10	32.00
68.6	50	25 x 150	10	44.00
68.7	75	25 x 200	10	58.00



65.1



66.1



67.1



68.1

### 69.1 Test Tubes, "Labglas", Boro 33exp. glass, Round bottom, rimless, Plain.

Cat. No.	Capacity (ml approx)	O.D. x Length (mm approx)	Qty / Pack	Price / Piece (Rs.)
69.1	3	10 x 75	100	3.00
69.2	5	12 x 75	100	360.00
69.3	8	12 x 100	100	5.00
69.4	10	15 x 125	100	7.00
69.5	15	15 x 150	100	9.00
69.6	25	18 x 150	100	12.20.00
69.7	35	25 x 100	50	13.05.00
69.8	50	25 x 150	50	15.00
69.9	75	25 x 200	50	22.50.00
69.10	100	32 x 200	25	38.00
69.11	170	38 x 200	25	45.00



69.1

### 70.1 Test Tubes, "Labglas", Round bottom, with rim, made from Neutral Hard Glass, Heat resistant, Autoclaveable.

Cat. No.	O.D. x Length (mm approx)	W.T. (mm approx)	Qty / Pack	Price / Piece (Rs.)
70.1	10 x 75	0.9	100	240.00
70.2	12 x 75	0.9	100	270.00
70.3	12 x 100	0.9	100	310.00
70.4	15 x 100	0.9	100	350.00
70.5	15 x 125	0.9	100	430.00
70.6	15 x 150	0.9	100	520.00
70.7	18 x 150	0.9	100	630.00
70.8	25 x 150	1	50	890.00
70.9	25 x 200	1	50	1120.00



70.1

### 71.1 Test Tubes, "Labglas", Round bottom, without rim, made from Neutral Hard Glass, Heat resistant, Autoclaveable.

Cat. No.	O.D. x Length (mm approx)	W.T. (mm approx)	Qty / Pack	Price / Piece (Rs.)
71.1	10 x 75	0.9	100	240.00
71.2	12 x 75	0.9	100	270.00
71.3	12 x 100	0.9	100	310.00
71.4	15 x 100	0.9	100	350.00
71.5	15 x 125	0.9	100	460.00
71.6	15 x 150	0.9	100	520.00
71.7	18 x 150	0.9	100	630.00
71.8	25 x 150	1	50	910.00
71.9	25 x 200	1	50	1120.00



71.1

### 72.1 Tubes Funnel Test Tubes.

Cat. No.	Capacity (ml)	Price / Piece (Rs.)
72.1	15	70.00
72.2	30	80.00

### 73.1 Tubes, Kjeldahl Digestion, "Labglas", with constriction on top.

Cat. No.	O.D. x Length (ml)	Price / Piece (Rs.)
73.1	24 x 250	130.00
73.2	26 x 250	145.00
73.3	40 x 300	245.00

### 74.1 Blood Sugar Tubes, "Labglas", Folin Wu, as per capacity 25 ml, marked at 4, 12.5 and 25 ml. 68.00

### 75.1 Wintrobe Tubes, "Labglas", 100 mm. Graduated. 20.00

### 76.1 Durham Tube, "Labglas",

Cat. No.	Size (mm)	Qty / Pack	Price / Piece (Rs.)
76.1	25 x 6	100	3.80.00
76.2	37 x 6	100	4.20.00
76.3	50 x 6	100	4.90.00

### 77.1 Co-Agulation Tube (Melting Point Capillary) Length 100 mm, 100/vial 70.00

### 78.1 Melting point Capillary, Length 75 mm, 100/vial 45.00

## BEAKERS

### 79.1 Beakers Low form, "Labglas", with spout, Approx. graduation $\pm 5\%$ accuracy.

Cat. No.	Capacity (ml)	Price / Piece (Rs.)
79.1	*5	35.00
79.2	*10	37.00
79.3	25	38.00
79.4	50	40.00
79.5	100	45.00
79.6	150	50.00
79.7	250	57.00
79.8	400	95.00
79.9	500	97.00
79.10	600	110.00
79.11	800	105.00
79.12	1000	205.00
79.13	2000	465.00
79.14	3000	990.00
79.15	5000	1435.00
79.16	10000	4635.00

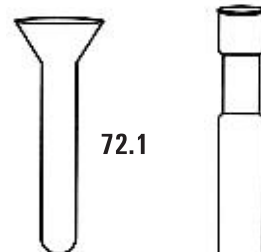

72.1

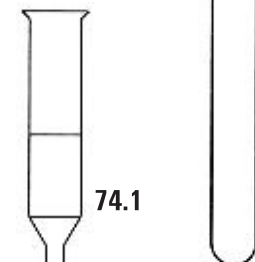

73.1

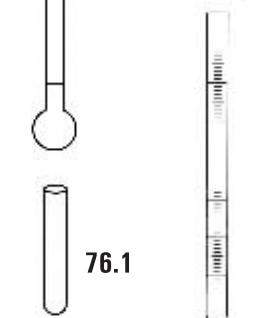

74.1

75.1

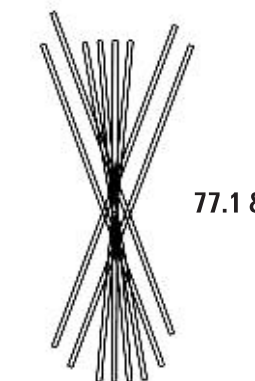

76.1

77.1 & 78.1

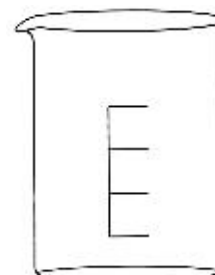

79.1

## Beakers

### 80.1 Beakers Tall form, "Labglas", with spout, graduation $\pm 5\%$ accuracy.

Cat. No.	Capacity (ml)	Price / Piece (Rs.)
80.1	50	66.00
80.2	100	73.00
80.3	150	78.00
80.4	250	85.00
80.5	500	130.00
80.6	1000	255.00

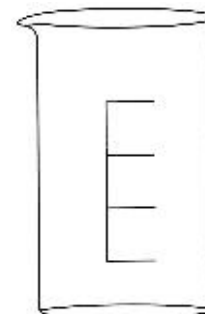

80.1

### 81.1 Beakers Tall form, "Labglas", without spout, graduation $\pm 5\%$ accuracy.

Cat. No.	Capacity (ml)	Price / Piece (Rs.)
81.1	50	50.00
81.2	100	73.00
81.3	150	78.00
81.4	250	85.00
81.5	500	130.00
81.6	1000	255.00

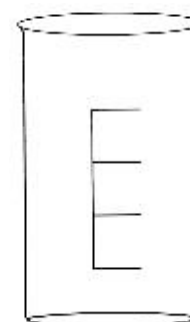

81.1

### 82.1 Beakers, Conical Shape, "Labglas", (Phillips Pattern) with spout.

Cat. No.	Capacity (ml)	Price / Piece (Rs.)
82.1	250	340.00
82.2	500	430.00



82.1

### 83.1 Beaker Tablet Disintegration, as per B. P. 1000 ml. OD x Ht. (mm) 105 x 145, spoutless. 265.00

## BOTTLES

### 84.1 Reagent Bottles, "Labglas", Narrow Mouth, with interchangeable Stopper.

Cat. No.	Capacity (ml)	Stopper Size	Price / Piece (Rs.)
84.1	25/30*	14/23	120.00
84.2	50/60*	14/23	155.00
84.3	100/125*	19/26	225.00
84.4	250	19/26	255.00
84.5	500	24/29	295.00
84.6	1000	29/32	460.00
84.7	2000	34/35	800.00
84.8	3000*	45/40	1890.00
84.9	5000*	45/40	4860.00

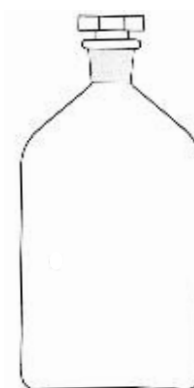

84.1



**85.1 Reagent Bottles, "Labglas", Amber, Narrow Mouth, with interchangeable stopper.**

Cat. No.	Capacity (ml)	Stopper Size	Price / Piece (Rs.)
85.1	25/30*	14/23	250.00
85.2	50/60*	14/23	330.00
85.3	100/125*	19/26	370.00
85.4	250	19/26	495.00
85.5	500	24/29	530.00
85.6	1000	29/32	680.00
85.7	2000	34/35	1290.00
85.8	3000*	45/40	6030.00
85.9	5000*	45/40	8370.00



85.1

**86.1 Reagent Bottle "Labglas", Clear, wide mouth with Polypropylene Blue screw cap and pouring ring, autoclavable, Graduated.**

Cat. No.	Capacity (ml)	DIN Thread Size	Price / Piece (Rs.)
86.1	10 ^*	GL 25	135.00
86.2	25 ^	GL 25	155.00
86.3	50^	GL 32	195.00
86.4	100	GL 45	215.00
86.5	150*^	GL 45	225.00
86.6	250	GL 45	235.00
86.7	500	GL 45	245.00
86.8	1000	GL 45	410.00
86.9	2000	GL 45	790.00
86.10	3000*	GL 45	3015.00
86.11	5000	GL 45	4050.00
86.12	10000	GL 45	6480.00
86.13	20000	GL 45	10800.00

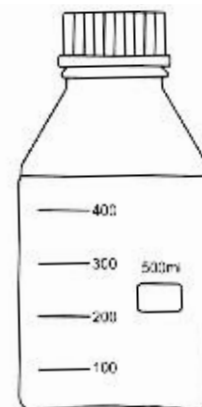

86.1

**87.1 Reagent Bottle "Labglas", Amber, wide mouth with Polypropylene Blue screw cap and pouring ring, autoclavable, graduated.**

Cat. No.	Capacity (ml)	DIN Thread Size	Price / Piece (Rs.)
87.1	25^	GL 25	268.50.00
87.2	50^	GL 32	278.00
87.3	100	GL 45	385.00
87.4	250	GL 45	410.00
87.5	500	GL 45	485.00
87.6	1000	GL 45	610.00
87.7	2000	GL 45	1075.00
87.8	3000*	GL 45	4860.00
87.9	5000	GL 45	6480.00
87.10	10000	GL 45	8730.00
87.11	20000	GL 45	13275.00

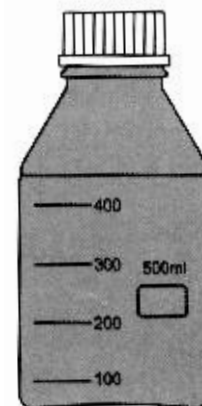

87.1

## Bottles

**88.1 Reagent Bottle "Labglas", Clear, extra wide mouth with Polypropylene Blue screw cap and pouring ring, repeatedly autoclavable, Graduated.**

Cat. No.	Capacity (ml)	DIN Thread Size	Price / Piece (Rs.)
88.1	5000	GL 80	5220.00
88.2	10000	GL 80	7560.00
88.3	20000	GL 80	15480.00
88.4	500	GL 80	610.00
88.5	1000	GL 80	720.00
88.6	2000	GL 80	1080.00

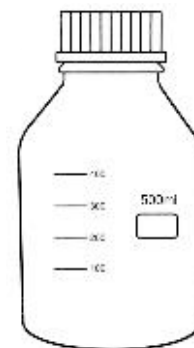

88.1

**89.1 Reagent Bottle "Labglas", Amber, extra wide mouth with Polypropylene Blue screw cap & pouring ring, repeatedly autoclavable, Graduated.**

Cat. No.	Capacity (ml)	DIN Thread Size	Price / Piece (Rs.)
89.1	5000	GL 80	7695.00
89.2	10000	GL 80	11485.00
89.3	20000	GL 80	21825.00
89.4	500	GL 80	855.00
89.5	1000	GL 80	1010.00
89.6	2000	GL 80	1450.00



89.1

**90.1 Weighing Bottles, "Labglas", with interchangeable stopper.**

Cat. No.	Type	O.D. x Ht. (mm approx)	Capacity Approx (ml)	Price / Piece (Rs.)
90.1	Squat form	40 x 30	20	175.00
90.2		50 x 25	20	215.00
90.3		50 x 35	35	220.00
90.4		50 x 50	50	225.00
90.5		60 x 40	40	310.00
90.6	Tall form	20 x 40	5	89.00
90.7		25 x 60	15	95.00
90.8		30 x 65	25	125.00
90.9		40 x 90	60	178.00

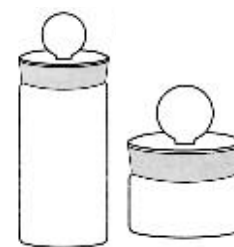

90.1

**91.1 Specific Gravity Bottles, "Labglas", Ground Standard neck with interchangeable PTFE stopper, Class 'A'**

Cat. No.	Capacity (ml)	Tolerance ( $\pm$ ml)	Price / Piece (Rs.)
91.1	10	0.3	240.00
91.2	25	0.8	245.00
91.3	50	1	250.00
91.4	100	2	395.00



91.1

## Bottles

### 92.1 Specific Gravity Bottles, "Labglas", Ground Standard neck with interchangeable PTFE stopper, Class 'A'

Cat. No.	Capacity (ml)	Tolerance ( $\pm$ ml)	Price / Piece (Rs.)
92.1	10	0.3	440.00
92.2	25	0.8	450.00
92.3	50	1	470.00
92.4	100	2	740.00

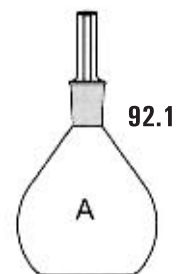

### 93.1 Specific Gravity Bottles, "Labglas", Ground capillary stopper.

Cat. No.	Capacity (ml)	Price / Piece (Rs.)
93.1	10	75.00
93.2	25	78.00
93.3	50	87.00
93.4	100	185.00

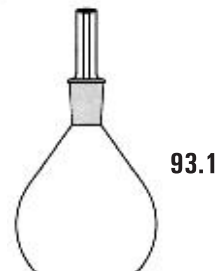

### 94.1 Specific Gravity Bottles, "Labglas", with standard joint thermometer, range 0° to 50°C (Pyknometer).

Cat. No.	Capacity (ml)	Price / Piece (Rs.)
94.1	25	470.00
94.2	50	490.00

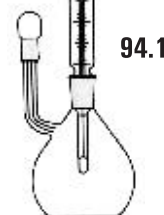

### 95.1 Specific Gravy Bottles, "Labglas", Class 'A'

Cat. No.	Capacity (ml)	Price / Piece (Rs.)
95.1	25	585.00
95.2	50	595.00

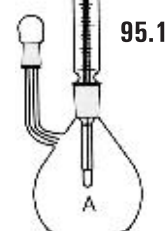

### 96.1 Bottles Dropping, "Labglas", fitted with interchangeable joint dropping pipette and rubber teat.

Cat. No.	Capacity (ml)	Price / Piece (Rs.)
96.1	25/30	160.00
96.2	50/60	170.00
96.3	100/125	210.00
96.4	250	340.00



### 97.1 Bottles Aspirator, "Labglas", with I/C stopper or Screw Cap, stopcock with interchangeable joint.

Cat. No.	Capacity (ml)	Price / Piece (Rs.)
97.1	1000	1485.00
97.2	2000	1780.00
97.3	3000	3240.00
97.4	5000	5265.00
97.5	10000	7020.00
97.6	20000	11610.00

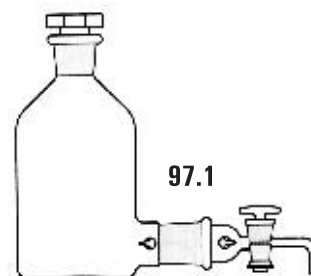

### 98.1 Bottles Aspirator, "Labglas", with Outlet for Tubing.

Cat. No.	Capacity (ml)	Price / Piece (Rs.)
98.1	250	275.00
98.2	500	375.00
98.3	1000	545.00
98.4	2000	940.00



### 99.1 Wouff Bottles, "Labglas", with two standard joint necks.

Cat. No.	Capacity (ml)	Price / Piece (Rs.)
99.1	250	360.00
99.2	500	395.00
99.3	1000	660.00

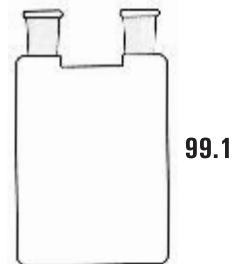

### 100.1 Mac-Cartney Bottles, "Labglas", Complete with Aluminum Cap and Rubber Liner.

Cat. No.	Capacity (ml)	Minimum Qty/Pack	Price / Piece (Rs.)
100.1	5	25	25.00
100.2	15	25	35.00
100.3	30	25	45.00
100.4	60	25	68.00

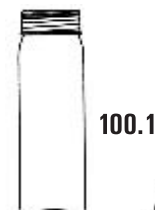

### 101.1 Bottles, B.O.D. with interchangeable stopper "Labglas".

Cat. No.	Capacity (ml)	Approx. (mm) OD x Height	Price / Piece (Rs.)
101.1	60*	42 x 100	195.00
101.2	125*	55 x 120	275.00
101.3	300	70 x 143	350.00



## DISHES

### 102.1 Petri Dishes, "Labglas", Boro 33 Glass, repeatedly autoclavable.

Cat. No.	O.D. x Height (mm approx)	Price / Piece (Rs.)
102.1	50 x 17	95.00
102.2	62 x 17	115.00
102.3	80 x 17	120.00
102.4	100 x 17	130.00
102.5	150 x 20	395.00



### 103.1 Petri Dishes, "Labglas", Boro 33 Glass, Amber, repeatedly autoclavable.

Cat. No.	O.D. x Height (mm approx)	Price / Piece (Rs.)
103.1	50 x 17	250.00
103.2	80 x 17	295.00
103.3	100 x 17	340.00
103.4	150 x 17	770.00
103.5	200 x 20	1295.00

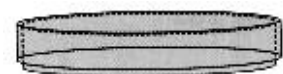

### 104.1 Dishes Crystallizing, "Labglas", with / without Spout.

Cat. No.	O.D. x Ht. (mm approx)	Capacity (ml approx)	Price / Piece (Rs.)
104.1	40 x 25	20	55.00
104.2	50 x 30	40	72.00
104.3	60 x 35	60	88.00
104.4	70 x 40	100	135.00
104.5	80 x 45	150	170.00
104.6	100 x 50	300	295.00
104.7	115 x 65	500	470.00
104.8	150 x 75	1000	530.00
104.9	190 x 100	2000	1050.00



### 105.1 Dishes Evaporating, "Labglas", Flat Bottom, with Spout.

Cat. No.	O.D. x Ht. (mm approx)	Capacity (ml approx)	Price / Piece (Rs.)
105.1	50 x 25	15	95.00
105.2	60 x 30	45	125.00
105.3	80 x 45	90	150.00
105.4	95 x 55	170	245.00
105.5	150 x 80	600	540.00
105.6	200 x 100	1500	1250.00



## DESSICATORS

### 106.1 Desiccators Plain with knobbed lid, Ground Flanges, Neutral Glass, supplied with Porcelain perforated plate.

Cat. No.	Dia (mm)	Price / Piece (Rs.)
106.1	120	855.00
106.2	160	1230.00
106.3	210	2010.00
106.4	240	3140.00
106.5	300	5050.00

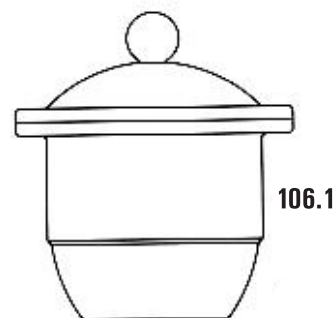

### 107.1 Desiccators, Vacuum with tubular Lid, Ground Flanges, and stopcock, Neutral glass, supplied with perforated porcelain plate.

Cat. No.	Dia (mm)	Price / Piece (Rs.)
107.1	160	1710.00
107.2	210	3100.00
107.3	240	4540.00
107.4	300	6810.00

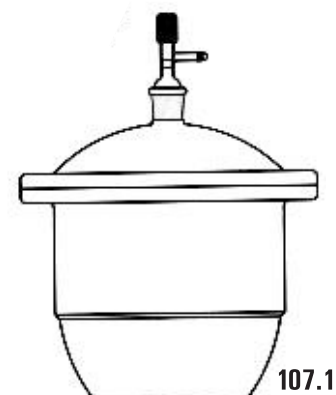

## Jars / Funnels

**108.1 Culture Jars (Specimen), "Labglas", with Polypropylene screw cap and Rubber liner, suitable for Culture, Autoclave able.**

Cat. No.	O.D. x Ht. (mm approx)	Capacity (mm approx)	Price / Piece (Rs.)
108.1	50 x 75	100	168.00
108.2	60 x 110	250	228.00
108.3	75 x 130	500	340.00
108.4	90 x 185	1000	580.00



108.1

**109.1 Culture Jar with Screw Cap, Autoclaves, S-Glass, 75 x 130 mm (d x h), 450 ml. approx.** 120.00

**110.1 Jars, Rectangular, Museum, Neutral glass with cover (Chromatography Tank).**

Cat. No.	Height (mm)	Length (mm)	Length (mm)	Price / Piece (Rs.)
110.1	140	215	100	1220.00
110.2	210	170	130	1445.00
110.3	220	140	140	1445.00
110.4	225	225	125	1980.00
110.5	250	250	150	2980.00

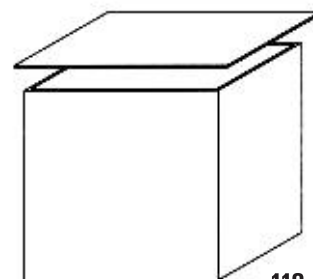

110.1

**111.1 Jars-Bell, Round Bottom, Edge Ground "Labglas".**

Cat. No.	O.D. x Height (mm approx)	Price / Piece (Rs.)
111.1	300 x 450	14130.00
111.2	300 x 400	13410.00
111.3	200 x 350	8550.00

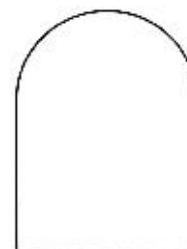

111.1

## FUNNELS

**112.1 Funnel Filtering, "Labglas",**

Cat. No.	Diameter (mm)	Bottom Tube (Dia mm)	To suit Filter Paper Dia mm	Price / Piece (Rs.)
112.1	35	6	45-55	27.00
112.2	45	6	55-70	30.00
112.3	55	8	70-90	32.00
112.4	70	8	110-125	46.00
112.5	80	8	125-150	50.00
112.6	100	10	150-185	85.00
112.7	120	16	185-240	195.00
112.8	150	16	240-270	290.00
112.9	200	24	320-385	480.00

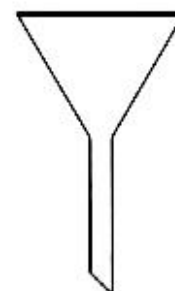

112.1

### FUNNELS

#### 113.1 Funnel-Powder, Short Plain Stem "Labglas".

Cat. No.	Diameter (mm)	Bottom Tube (Dia mm)	Price / Piece (Rs.)
113.1	55	20	55.00
113.2	70	22	65.00
113.3	80	24	70.00
113.4	100	26	120.00
113.5	125	35	205.00
113.6	150	35	305.00
113.7	200	40	590.00

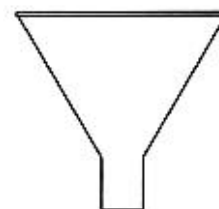

113.1

#### 114.1 Powder Funnel with conce at stem, "Labglas".

Cat. No.	Diameter (mm)	Cone Size	Price / Piece (Rs.)
114.1	100	21/29	165.00
114.2	125	24/29	240.00
114.3	150	24/29	365.00
114.4	200	24/29	710.00



114.1

115.1 Thistle Funnel, "Labglas", 30 cm stem 42.00

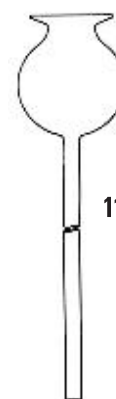

115.1

116.1 Thistle Funnel, "Labglas", for Kipp's Apparatus 100.00

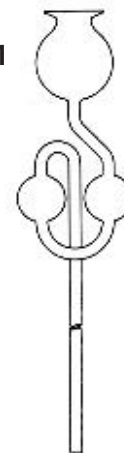

116.1

### FLASKS

#### 117.1 Flasks, Erlenmeyer, "Labglas", Conical, Narrow mouth, with approx. Graduation.

Cat. No.	Capacity (ml)	Approx Neck (OD mm)	Graduation (Interval ml)	Price / Piece (Rs.)
117.1	5*	-	-	25.00
117.2	10*	-	-	26.00
117.3	25	22	-	47.00
117.4	50	22	-	55.00
117.5	100	26	25	58.00
117.6	150*	28	25	78.00
117.7	250	34	50	95.00
117.8	500	34	100	132.00
117.9	1000	42	200	240.00
117.10	2000	48	500	590.00
117.11	3000	48	500	1090.00
117.12	5000	50	500	1870.00

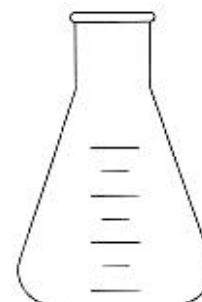

117.1



### 118.1 Flasks, Erlenmeyer, "Labglas", Amber Conical, Narrow mouth, with approx. Graduation

Cat. No.	Capacity (ml)	Price / Piece (Rs.)
118.1	50	120.00
118.2	100	130.00
118.3	250	175.00
118.4	500	285.00
118.5	1000	490.00
118.6	2000	1210.00

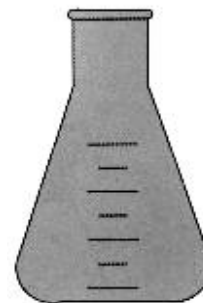

118.1

### 119.1 Flasks, Erlenmeyer, "Labglas", Conical, Wide mouth, approx. Graduation.

Cat. No.	Capacity (ml)	O.D. x Ht. (mm approx)	Approx Neck (O.D. mm)	Price / Piece (Rs.)
119.1	100	64 x 105	34	67.00
119.2	250	85 x 142	50	95.00
119.3	500	105 x 175	50	165.00
119.4	1000	130 x 220	56	255.00
119.5	2000	150 x 275	70	710.00

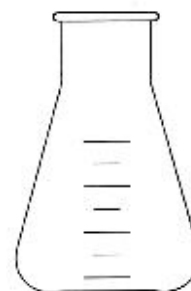

119.1

### 120.1 Flasks Conical, "Labglas", Rimless, Suitable for culture.

Cat. No.	Capacity (ml)	O.D. x Ht. (mm approx)	Approx Neck (O.D. mm)	Price / Piece (Rs.)
120.1	250	78 x 154	25	130.00
120.2	750	114 x 210	34	275.00

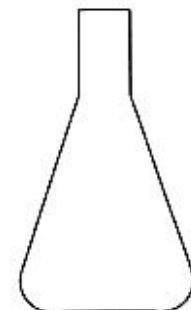

120.1

### 121.1 Flasks Erlenmeyer, "Labglas", Conical, with interchangeable stopper.

Cat. No.	Capacity (ml)	Stopper Size	Price / Piece (Rs.)
121.1	25	14/23	115.00
121.2	50	19/26	130.00
121.3	100	24/29	150.00
121.4	150	24/29	178.00
121.5	250	24/29	205.00
121.6	500	24/29	278.00
121.7	1000	29/32	505.00
121.8	2000	34/35	910.00

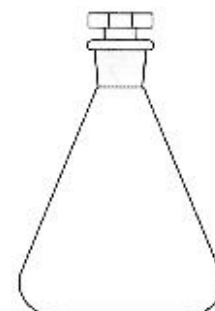

121.1

### 122.1 Flasks Erlenmeyer, "Labglas", Amber, Conical, Narrow mouth, with Interchangeable stopper.

Cat. No.	Capacity (ml)	Stopper Size	Price / Piece (Rs.)
122.1	25	14/23	210.00
122.2	50	19/26	245.00
122.3	100	24/29	295.00
122.4	250	24/29	355.00
122.5	500	24/29	565.00

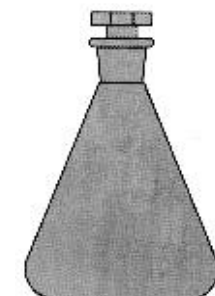

122.1



### 123.1 Flasks Erlenmeyer, "Labglas", Conical, with Screw Cap and liner.

Cat. No.	Capacity (ml)	Thread Size	Price / Piece (Rs.)
123.1	25	GL - 18	105.00
123.2	50	GL - 18	130.00
123.3	100	GL - 25	150.00
123.4	150	GL - 25	195.00
123.5	250	GL - 32	205.00
123.6	500	GL - 32	295.00
123.7	1000	GL - 32	505.00
123.8	2000	GL - 32	910.00
123.9	5000	GL - 45	2850.00

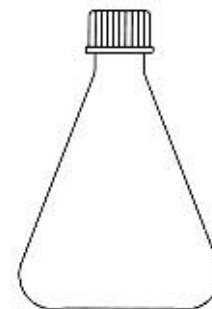

123.1

### 124.1 Flasks Iodine, "Labglas", with funnel shaped cup and stopper.

Cat. No.	Capacity (ml)	Stopper Size	Price / Piece (Rs.)
124.1	100	24/29	165.00
124.2	250	24/29	205.00
124.3	500	24/29	270.00
124.4	1000	24/29	410.00



124.1

### 125.1 Flasks Filtering, Heavy wall, with tubulation, "Labglas".

Cat. No.	Capacity (ml)	Price / Piece (Rs.)
125.1	50	125.00
125.2	100	175.00
125.3	250	255.00
125.4	500	390.00
125.5	1000	580.00
125.6	2000	990.00
125.7	5000	3645.00
125.8	*10000	7380.00
125.9	*20000	11250.00

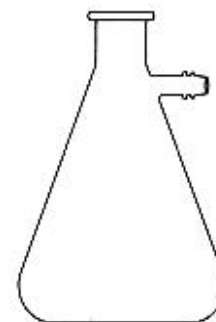

125.1

### 126.1 Flasks, Kjeldhal, "Labglas", Round Bottom, long neck, Plain

Cat. No.	Capacity (ml)	O.D. x Ht. (approx mm)	Price / Piece (Rs.)
126.1	10	30 x 180	50.00
126.2	30	40 x 180	72.00
126.3	50	45 x 200	110.00
126.4	100	60 x 220	130.00
126.5	300	80 x 300	210.00
126.6	500	98 x 325	350.00
126.7	800	115 x 350	410.00



126.1

### 127.1 Flasks Distillation, "Labglas", with side tube at 75° angle.

Cat. No.	Capacity (ml)	O.D. x Ht. (Approx mm)	Neck OD (Approx mm)	Price / Piece (Rs.)
127.1	100	64 x 210	21	140.00
127.2	125*	68 x 214	19	150.00
127.3	250	88 x 226	25	190.00
127.4	500	110 x 250	28	255.00

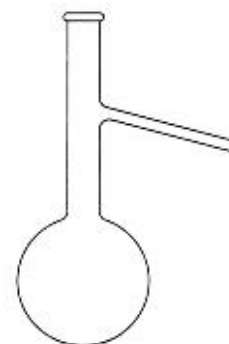

127.1

### 128.1 Flasks Boiling, Round Bottom, "Labglas".

Cat. No.	Capacity (ml)	Price / Piece (Rs.)
128.1	50	55.00
128.2	100	75.00
128.3	150	85.00
128.4	250	95.00
128.5	500	145.00
128.6	1000	230.00
128.7	2000	510.00
128.8	3000	1150.00
128.9	5000	1950.00
128.10	10000	4050.00
128.11	20000	7800.00

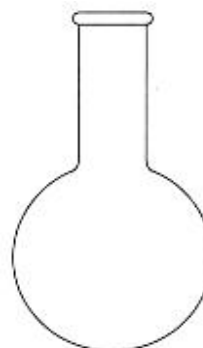

128.1

### 129.1 Flasks Boiling, Flat Bottom, "Labglas".

Cat. No.	Capacity (ml)	Price / Piece (Rs.)
129.1	50	55.00
129.2	100	75.00
129.3	150	85.00
129.4	250	95.00
129.5	500	145.00
129.6	1000	230.00
129.7	2000	510.00
129.8	3000	1150.00
129.9	5000	1950.00
129.10	10000	4050.00
129.11	20000	7800.00

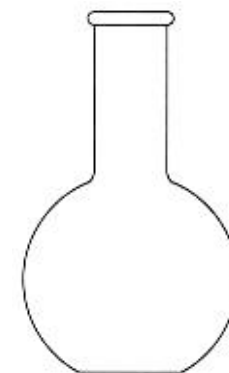

129.1

### 130.1 Flasks Culture, Halfline "Labglas".

Cat. No.	Capacity (ml)	Approx OD x Ht. (mm)	Price / Piece (Rs.)
130.1	3000	241 x 273	2115.00
130.2	4000	245 x 310	2430.00

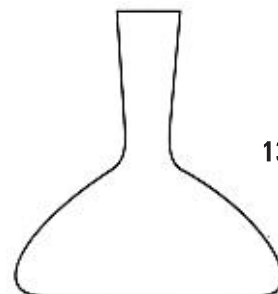

130.1

### 131.1 Kettles Resin Reaction "Labglas".

Cat. No.	Capacity (ml)	Price / Piece (Rs.)
131.1	500	5850.00
131.2	1000	6480.00
131.3	2000	7875.00
131.4	4000	9675.00

### 132.1 Flasks Round Bottom, "Labglas", with socket.

Cat. No.	Capacity (ml)	Socket	Price / Piece (Rs.)
132.1	5	14/23	55.00
132.2	10	14/23	58.00
132.3	25	14/23	78.00
132.4	25	19/26	78.00
132.5	50	19/26	105.00
132.6	50	24/29	105.00
132.7	100	19/26	128.00
132.8	100	24/29	128.00
132.9	150	19/26	150.00
132.10	150	24/29	150.00
132.11	250	19/26	155.00
132.12	250	24/29	155.00
132.13	500	19/26	215.00
132.14	500	24/29	215.00
132.15	1000	24/29	315.00
132.16	2000	24/29	615.00
132.17	3000	34/35	1530.00
132.18	5000	34/35	2470.00
132.19	10000	55/44	4670.00
132.20	20000	55/44	9050.00

### 133.1 Flasks Flat Bottom, "Labglas", with socket.

Cat. No.	Capacity (ml)	Socket	Price / Piece (Rs.)
133.1	5	14/23	55.00
133.2	10	14/23	58.00
133.3	25	14/23	78.00
133.4	25	19/26	78.00
133.5	50	19/26	105.00
133.6	50	24/29	105.00
133.7	100	19/26	128.00
133.8	100	24/29	128.00
133.9	150	19/26	150.00
133.10	150	24/29	150.00
133.11	250	19/26	155.00
133.12	250	24/29	155.00
133.13	500	19/26	215.00
133.14	500	24/29	215.00
133.15	1000	24/29	315.00
133.16	2000	24/29	615.00
133.17	3000	34/35	1530.00
133.18	5000	34/35	2470.00
133.19	10000	55/44	4670.00
133.20	20000	55/44	9050.00

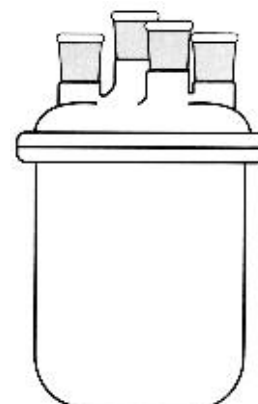

131.1

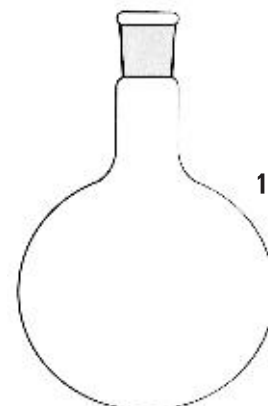

132.1



133.1

### 134.1 Flasks Round Bottom, Two Neck, "Labglas" (Side neck at Angle or Parallel).

Cat. No.	Capacity (ml)	Centre Socket	Side Socket	Price / Piece (Rs.)
134.1	25	19/26	14/23	170.00
134.2	25	24/29	19/26	170.00
134.3	50	19/26	14/23	190.00
134.4	50	24/29	19/29	190.00
134.5	100	24/29	14/23	180.00
134.6	100	19/26	14/23	180.00
134.7	250	24/29	14/23	245.00
134.8	250	24/29	19/26	250.00
134.9	500	24/29	14/23	365.00
134.10	500	24/29	19/26	370.00
134.11	1000	24/29	14/23	450.00
134.12	1000	24/29	19/26	455.00
134.13	2000	34/35	19/26	845.00
134.14	2000	24/29	19/26	845.00
134.15	3000	34/35	19/26	1960.00
134.16	5000	34/35	24/29	2745.00
134.17	5000	34/35	19/26	2745.00
134.18	10000	55/44	24/29	5445.00
134.19	20000	55/44	24/29	8550.00



134.1 (P)

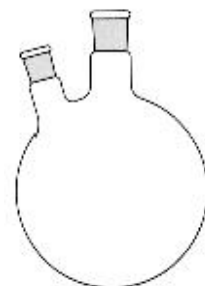

134.1 (A)

### 135.1 Flask Round Bottom, Three Neck, "Labglas", (Side necks at angle or parallel).

Cat. No.	Capacity (ml)	Centre Socket	Side Socket	Price / Piece (Rs.)
135.1	50	19/26	14/23	225.00
135.2	50	24/29	19/26	225.00
135.3	100	19/26	14/23	230.00
135.4	100	24/29	14/23	230.00
135.5	250	24/29	14/23	335.00
135.6	250	24/29	19/26	340.00
135.7	500	24/29	14/23	505.00
135.8	500	24/29	19/26	510.00
135.9	1000	24/29	19/26	625.00
135.10	1000	34/35	19/26	625.00
135.11	2000	24/29	19/26	1010.00
135.12	2000	34/35	24/29	1015.00
135.13	3000	34/35	24/29	2470.00
135.14	5000	34/35	19/26	3350.00
135.15	10000	55/44	24/29	6890.00
135.16	20000	55/44	24/29	10150.00

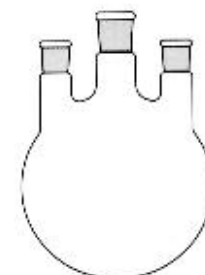

135.1 (P)

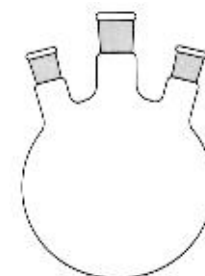

135.1 (A)

### 136.1 Flask Erlenmeyer, "Labglas", Conical, with socket.

Cat. No.	Capacity (ml)	Centre Socket	Price / Piece (Rs.)
136.1	25	14/23	85.00
136.2	50	14/23	95.00
136.3	50	19/26	95.00
136.4	100	19/26	120.00
136.5	100	24/29	120.00
136.6	150	19/26	145.00
136.7	150	24/29	145.00
136.8	250	19/26	150.00
136.9	250	24/29	150.00
136.10	250	29/32	150.00
136.11	500	19/26	225.00
136.12	500	24/29	225.00
136.13	500	29/32	230.00
136.14	1000	24/29	410.00
136.15	1000	34/35	415.00
136.16	2000	24/29	835.00
136.17	2000	34/35	840.00

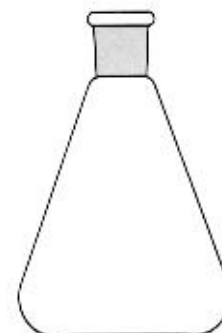

136.1

### 137.1 Flasks, Buchner, "Labglas", Filtration, Heavy wall, with tubulation and socket.

Cat. No.	Capacity (ml)	Centre Socket	Price / Piece (Rs.)
137.1	100	19/26	205.00
137.2	250	24/29	350.00
137.3	500	24/29	465.00
137.4	1000	24/29	815.00
137.5	1000	34/35	820.00
137.6	2000	34/35	1490.00

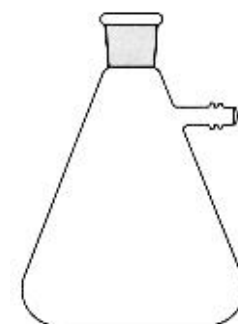

137.1

### 138.1 Flasks, Kjeldahl, "Labglas", with socket.

Cat. No.	Capacity (ml)	Centre Socket	Price / Piece (Rs.)
138.1	50	19/26	135.00
138.2	100	19/26	168.00
138.3	100	24/29	170.00
138.4	300	24/29	245.00
138.5	500	24/29	370.00
138.6	800	24/29	445.00
138.7	800	29/32	450.00

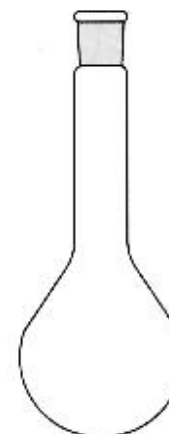

138.1

### 139.1 Flasks, Florentine, "Labglas", with socket.

Cat. No.	Capacity (ml)	Socket	Price / Piece (Rs.)
139.1	50	19/26	160.00
139.2	50	24/29	165.00
139.3	50	29/32	170.00
139.4	100	19/26	210.00
139.5	100	24/29	215.00
139.6	100	29/32	220.00
139.7	250	24/29	320.00
139.8	250	29/32	325.00
139.9	500	24/29	405.00
139.10	500	24/29	410.00
139.11	800	24/29	590.00
139.12	800	29/32	600.00
139.13	1000	29/32	780.00
139.14	2000	29/32	910.00

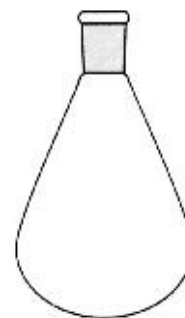

139.1

## CONDENSERS

### 140.1 Air Condensers, "Labglas".

Cat. No.	Socket	Cone	Effective Length (mm)	Price / Piece (Rs.)
140.1	14/23	14/23	200	130.00
140.2	19/26	19/26	200	155.00
140.3	24/29	24/29	250	215.00
140.4	19/26	19/26	400	240.00
140.5	24/29	24/29	500	305.00
140.6	-	19/26	750	150.00
140.7	-	24/29	750	155.00

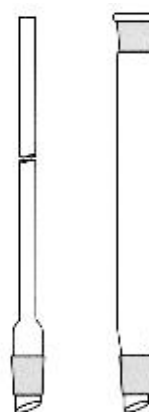

140.1

### 141.1 Liebig Condensers, "Labglas".

Cat. No.	Socket	Cone	Effective Length (mm)	Price / Piece (Rs.)
141.1	14/23	14/23	150	195.00
141.2	19/26	19/26	200	215.00
141.3	19/26	19/26	300	260.00
141.4	24/29	24/29	300	295.00
141.5	19/26	19/26	400	315.00
141.6	24/29	24/29	400	325.00
141.7	29/32	29/32	250	365.00
141.8	29/32	29/32	400	435.00



141.1

### 142.1 Coil Condensers, "Labglas", Graham, Coil Distillate Type.

Cat. No.	Socket	Cone	Effective Length (mm)	Price / Piece (Rs.)
142.1	24/29	24/29	300	490.00
142.2	24/29	24/29	400	590.00
142.3	24/29	24/29	500	570.00

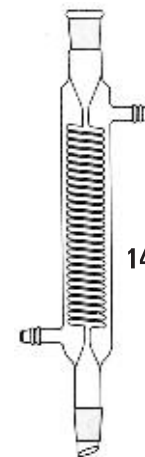

142.1

## Condensers

### 143.1 Coil Condensers, "Labglas", Graham, Jacket Distillate Type.

Cat. No.	Socket	Cone	Effective Length (mm)	Price / Piece (Rs.)
143.1	19/26	19/26	200	410.00
143.2	19/23	19/23	300	440.00
143.3	24/29	24/29	300	510.00
143.4	29/32	29/32	165	470.00
143.5	29/32	29/32	320	580.00

### 144.1 Double Coil Condensers, "Labglas" with common inlet.

Cat. No.	Socket	Cone	Effective Length (mm)	Price / Piece (Rs.)
144.1	19/26	19/26	200	950.00
144.2	24/29	24/29	200	960.00
144.3	34/35	34/35	350	2370.00
144.4	34/35	34/35	450	3490.00
144.5	34/35	34/35	600	3930.00

### 145.1 Davies Condensers, "Labglas" (Double Surface).

Cat. No.	Socket	Cone	Effective Length (mm)	Price / Piece (Rs.)
145.1	19/26	19/26	150	430.00
145.2	19/26	19/26	200	490.00
145.3	24/29	24/29	200	570.00
145.4	29/32	29/32	200	520.00
145.5	24/29	24/29	300	580.00
145.6	34/35	29/32	500	990.00

### 146.1 Jacketed Coil Condensers, "Labglas".

Cat. No.	Socket	Cone	Effective Length (mm)	Price / Piece (Rs.)
146.1	19/26	19/26	160	510.00
146.2	24/29	24/29	160	520.00
146.3	29/32	29/32	160	535.00
146.4	19/26	19/26	200	550.00
146.5	24/29	24/29	200	555.00
146.6	19/26	19/26	300	655.00
146.7	24/29	24/29	300	665.00

### 147.1 Inland Revenue Condensers, "Labglas".

Cat. No.	Socket	Cone	Effective Length (mm)	Price / Piece (Rs.)
147.1	19/26	19/26	200	665.00
147.2	24/29	24/29	200	675.00

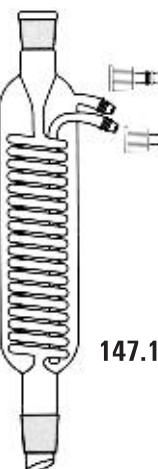
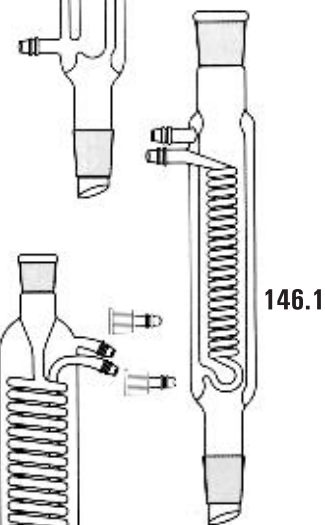
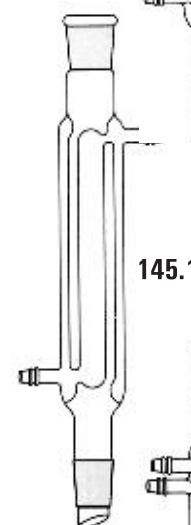
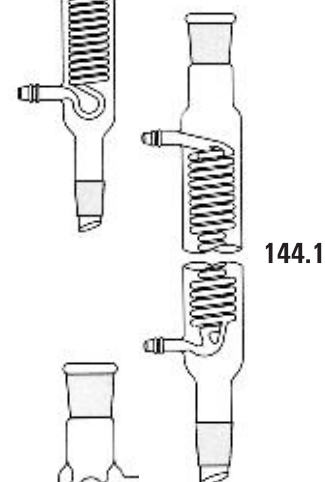

### 148.1 Allihn Condensers, "Labglas" (Bulb Condenser).

Cat. No.	Socket	Cone	Effective Length (mm)	Price / Piece (Rs.)
148.1	-	34/35	200	320.00
148.2	-	40/38	200	345.00
148.3	-	50/42	250	515.00
148.4	19/26	19/26	200	305.00
148.5	24/29	24/29	300	390.00
148.6	24/29	24/29	400	440.00
148.7	29/32	29/32	600	680.00

### 149.1 Friedrich Condensers, "Labglas"

Cat. No.	Socket	Cone	Effective Length (mm)	Price / Piece (Rs.)
149.1	19/26 or 24/29	19/26 or 24/29	200	1080.00

### 150.1 Ether Condensers, "Labglas".

Cat. No.	Socket	Cone	Effective Length (mm)	Price / Piece (Rs.)
150.1	19/26	24/29	200	1710.00

## CONDENSERS WITHOUT JOINTS

### 151.1 Liebig Condensers "Labglas".

Cat. No.	Effective Length (mm)	Price / Piece (Rs.)
151.1	200	180.00
151.2	300	195.00
151.3	400	228.00
151.4	500	320.00

### 152.1 Allihn Condensers, "Labglas", (Bulb Condenser).

Cat. No.	Effective Length (mm)	Price / Piece (Rs.)
152.1	200	270.00
152.2	300	355.00
152.3	400	415.00

### 153.1 Coil Condensers, "Labglas", (Graham Condenser).

Cat. No.	Effective Length (mm)	Price / Piece (Rs.)
153.1	200	360.00
153.2	300	415.00
153.3	400	485.00

### 154.1 Air Condensers, "Labglas".

Cat. No.	Effective Length (mm)	Price / Piece (Rs.)
154.1	400	82.00
154.2	600	95.00
154.3	750	144.00

### 155.1 Condensers, "Labglas", Bulb shape, suitable for 1000 ml. spout less, Tall form, Beaker.

380.00

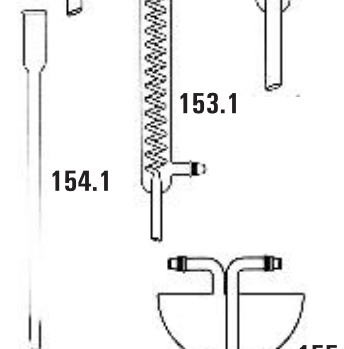
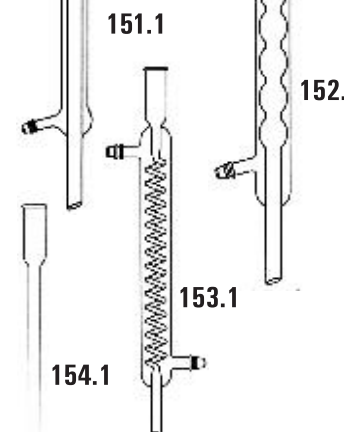
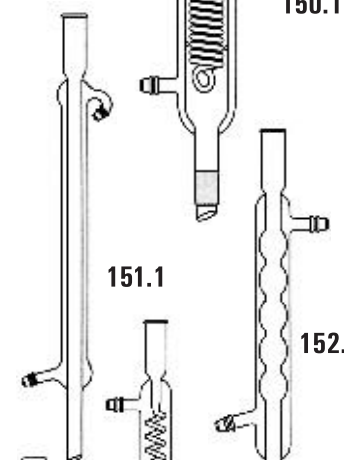
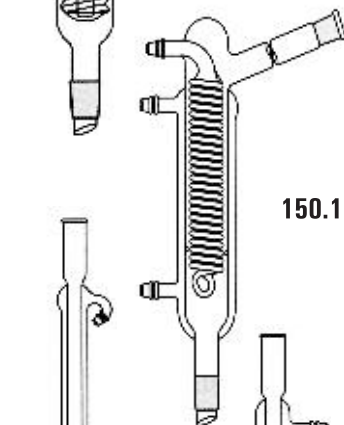
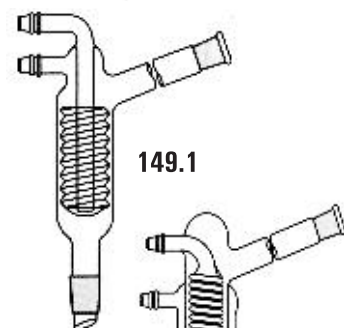
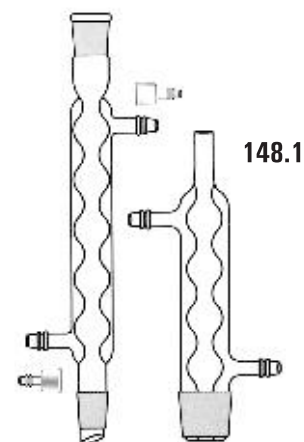



### STANDARD JOINTS, STOPPERS & ADAPTERS

#### 156.1 Sockets, "Labglas", Single or Double

Cat. No.	Socket Size	Price / Piece (Rs. Single)	Price / Piece (Rs. Double)
156.1	7/16	32.00	57.00
156.2	10/19	32.00	57.00
156.3	12/21	34.00	62.00
156.4	14/23	34.00	62.00
156.5	19/26	40.00	72.00
156.6	24/29	50.00	80.00
156.7	29/32	75.00	105.00
156.8	34/35	102.00	145.00
156.9	40/38	135.00	210.00
156.10	45/40	192.00	240.00
156.11	50/42	210.00	280.00
156.12	55/44	275.00	375.00

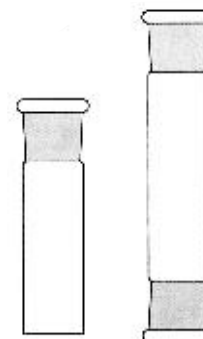

156.1

#### 157.1 Cones, "Labglas", Single or Double

Cat. No.	Cone Size	Price / Piece (Rs. Single)	Price / Piece (Rs. Double)
157.1	7/16	32.00	57.00
157.2	10/19	32.00	57.00
157.3	12/21	34.00	62.00
157.4	14/23	34.00	62.00
157.5	19/26	40.00	72.00
157.6	24/29	50.00	80.00
157.7	29/32	75.00	105.00
157.8	34/35	102.00	145.00
157.9	40/38	135.00	210.00
157.10	45/40	192.00	240.00
157.11	50/42	210.00	280.00
157.12	55/44	275.00	375.00

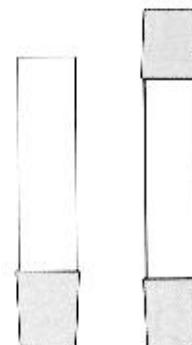

157.1

#### 158.1 Clips, Plastic for Holding Cone and Sockets.

Cat. No.	Joint Size	Price / Piece (Rs.)
158.1	14/19	22.00
158.2	19/26	22.00
158.3	24/29	24.00
158.4	29/32	26.00
158.5	34/35	32.00



158.1

#### 159.1 Ball & Socket, "Labglas".

Cat. No.	Joint Size	Approx. Bore mm	Price Pair (Rs.)	SS Clip (Rs.)
159.1	S 13	2	185.00	110.00
159.2	S 13	5	185.00	110.00
159.3	S 19	9	215.00	140.00
159.4	S 29	15	325.00	160.00
159.5	S 35	21	415.00	190.00
159.6	S 41	32	1065.00	380.00

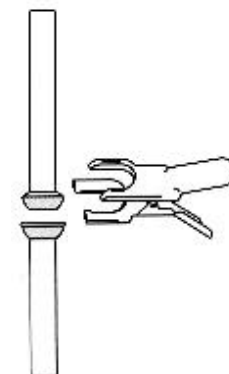

159.1

### 160.1 Stopper, "Labglas", Hollow.

Cat. No.	Shape	Cone Size	Price / Piece (Rs.)
160.1	Hexagonal Head	10/19	15.00
160.2	Hexagonal Head	12/21	18.00
160.3	Hexagonal Head	14/23	19.00
160.4	Hexagonal Head	19/26	24.00
160.5	Hexagonal Head	24/29	32.00
160.6	Hexagonal Head	29/32	50.00
160.7	Hexagonal Head	34/35	83.00
160.8	Penny Head	40/38	165.00
160.9	Penny Head	45/40	210.00
160.10	Penny Head	50/42	235.00
160.11	Penny Head	55/44	285.00

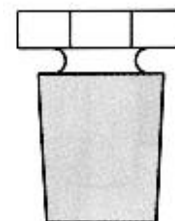

160.1

### 161.1 Stopper, "Labglas", Solid, Penny Head.

Cat. No.	Cone Size	Price / Piece (Rs.)
161.1	10/19	31.00
161.2	14/23	35.00
161.3	19/26	45.00
161.4	24/29	70.00
161.5	29/32	125.00
161.6	34/35	210.00



161.1

### 162.1 Stopper, "Labglas", Solid, Flat Head.

Cat. No.	Cone Size	Price / Piece (Rs.)
162.1	10/19	31.00
162.2	14/23	35.00
162.3	19/26	45.00
162.4	24/29	70.00
162.5	29/32	125.00
162.6	34/35	210.00



162.1

### 163.1 Stopper, Interchangeable, Amber.

Cat. No.	Size	Price / Piece (Rs.)
163.1	10/15	32.00
163.2	14/15	35.00
163.3	19/20	40.00
163.4	24/25	45.00
163.5	34/35	110.00

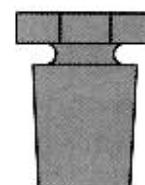

163.1

### 164.1 Multiple Adapters, "Labglas".

Cat. No.	Socket	Cone	Price / Piece (Rs.)
164.1	14/23	19/26	59.00
164.2	14/23	24/29	65.00
164.3	19/26	24/29	65.00
164.4	19/26	29/32	80.00
164.5	19/26	34/35	91.00
164.6	24/29	29/32	87.00
164.7	24/29	34/35	102.00
164.8	24/29	40/38	129.00
164.9	24/29	55/44	205.00
164.10	29/32	34/35	118.00
164.11	29/32	40/38	150.00

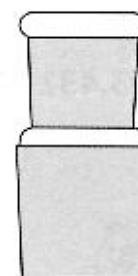

164.1

### 165.1 Expansion Adapters, "Labglas".

Cat. No.	Socket	Cone	Price / Piece (Rs.)
165.1	19/26	14/23	72.00
165.2	24/29	14/23	84.00
165.3	24/29	19/26	84.00
165.4	29/32	19/26	104.00
165.5	29/32	24/29	110.00
165.6	34/35	19/26	122.00
165.7	34/35	24/29	125.00
165.8	34/35	29/32	140.00
165.9	40/38	24/29	180.00

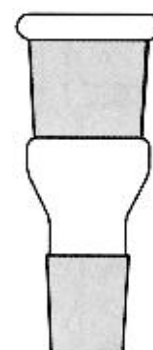

165.1

### 166.1 Multiple Adapters, "Labglas", with Two Necks Parallel.

Cat. No.	Socket	Cone	Price / Piece (Rs.)
166.1	14/23	14/23	158.00
166.2	19/26	19/26	176.00
166.3	19/26	24/29	185.00
166.4	24/29	24/29	205.00
166.5	29/32	29/32	270.00

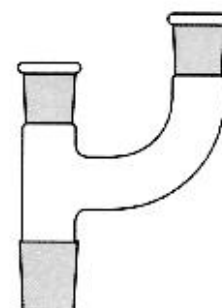

166.1

### 167.1 Multiple Adapters, "Labglas", with Two Necks at 45°.

Cat. No.	Socket	Cone	Price / Piece (Rs.)
167.1	19/26	19/26	176.00
167.2	19/26	24/29	185.00

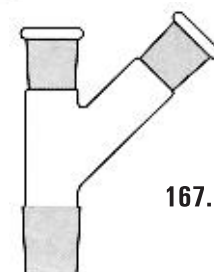

167.1

### 168.1 Multiple Adapter, "Labglas", with Three Necks, Two Parallel and one at 45°.

Cat. No.	Socket	Cone	Price / Piece (Rs.)
168.1	19/26	24/29	245.00
168.2	19/26	29/32	295.00
168.3	19/26	34/35	305.00

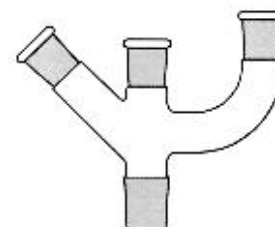

168.1

### 169.1 Receiver Adapter, "Labglas", Plain Bend Shot/Long.

Cat. No.	Socket	Price / Piece (Rs.)
169.1	14/23	72.00
169.2	19/26	80.00
169.3	24/29	95.00
169.4	29/32	105.00
169.5	34/35	130.00

### 170.1 Straight Delivery Adapters, "Labglas".

Cat. No.	Socket	Price / Piece (Rs.)
170.1	14/23	72.00
170.2	19/26	80.00
170.3	24/29	95.00
170.4	29/32	105.00
170.5	34/35	130.00

### 171.1 Receiver Adapters, "Labglas", Bend with Vent.

Cat. No.	Socket	Cone	Price / Piece (Rs.)
171.1	14/23	14/23	115.00
171.2	19/26	19/26	135.00
171.3	19/26	24/29	140.00
171.4	24/29	24/29	160.00
171.5	34/35	34/35	215.00

### 172.1 Receiver Adapter, "Labglas", Bend or Straight with Vacuum connection.

Cat. No.	Socket	Cone	Price / Piece (Rs.)
172.1	14/23	14/23	160.00
172.2	19/26	19/26	170.00
172.3	19/26	24/29	175.00
172.4	24/29	24/29	205.00
172.5	24/29	34/35	235.00

### 173.1 Receiver Adapter, "Labglas", with Socket Connections.

Cat. No.	Socket	Cone	Price / Piece (Rs.)
173.1	14/23	14/23	168.00
173.2	19/26	19/26	175.00
173.3	19/26	24/29	178.00

### 174.1 Receiver Adapters, "Labglas", Bend with Multiple Connections (Pig).

Cat. No.	Socket	Cone	Price / Piece (Rs.)
174.1	14/23	14/23	315.00
174.2	14/23	19/26	320.00
174.3	19/26	19/26	330.00

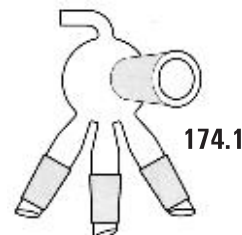
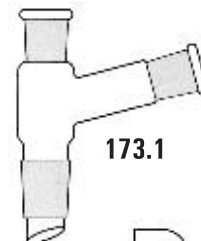
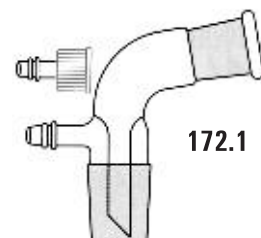
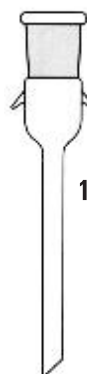
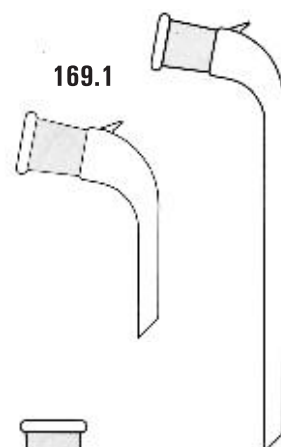

### 175.1 Receiver Adapters "Labglas", Plain Bend.

Cat. No.	Socket	Cone	Price / Piece (Rs.)
175.1	19/26	19/26	128.00
175.2	19/26	24/29	130.00
175.3	24/29	24/29	150.00
175.4	34/35	34/35	205.00

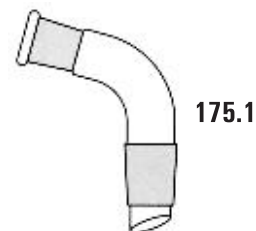

## STILL/SPLASH/RECOVERY HEADS

### 176.1 Still Heads, Recovery Bend, "Labglas", Sloping (Elbow).

Cat. No.	Cone Fitting Flask	Cone Fitting Condenser	Price / Piece (Rs.)
176.1	14/23	14/23	105.00
176.2	19/26	19/26	120.00
176.3	24/29	19/26	155.00
176.4	24/29	24/29	150.00
176.5	34/35	24/29	205.00
176.6	29/32	29/32	175.00

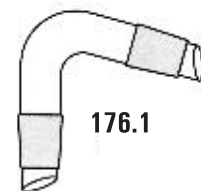

### 177.1 Still Heads, Recovery Bend, "Labglas", Vertical.

Cat. No.	Cone Fitting Flask	Cone Fitting Condenser	Price / Piece (Rs.)
177.1	14/23	14/23	140.00
177.2	19/26	19/26	160.00
177.3	24/29	24/29	215.00
177.4	34/35	34/35	325.00

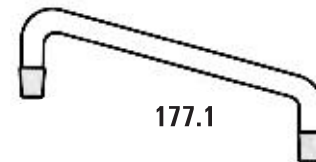

### 178.1 Recovery Head, "Labglas", Sloping with 14/23 Socket.

Cat. No.	Cone Fitting Flask	Cone Fitting Condenser	Price / Piece (Rs.)
178.1	14/23	14/23	160.00
178.2	19/26	19/26	186.00
178.3	24/29	19/26	190.00
178.4	24/29	24/29	205.00
178.5	34/35	24/29	335.00

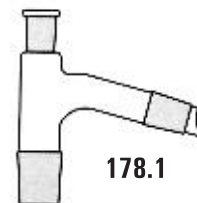

### 179.1 Splash Heads, "Labglas", Pear Shape, Sloping.

Cat. No.	Cone Fitting Flask	Cone Fitting Condenser	Price / Piece (Rs.)
179.1	19/26	19/26	215.00
179.2	24/29	19/26	220.00
179.3	34/35	24/29	265.00
179.4	24/29	24/29	225.00

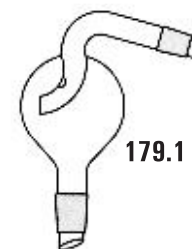

### 180.1 Splash Head, "Labglas", Pear Shape, Vertical

Cat. No.	Cone Fitting Flask	Cone Fitting Condenser	Price / Piece (Rs.)
180.1	19/26	19/26	295.00
180.2	24/29	19/26	305.00
180.3	24/29	24/29	310.00
180.4	34/35	24/29	345.00

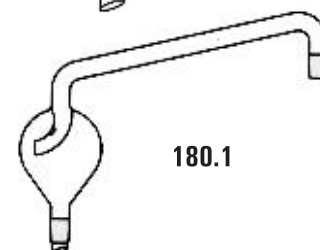



### 181.1 Splash Head Adapter, "Labglas".

Cat. No.	Cone Fitting Flask	Cone Fitting Condenser	Price / Piece (Rs.)
181.1	24/29	19/26	225.00

### 182.1 Steam Distillation Heads "Labglas", Pear Shape, Sloping.

Cat. No.	Cone Fitting Flask	Cone Fitting Condenser	Price / Piece (Rs.)
182.1	24/29	19/26	330.00
182.2	34/35	19/26	340.00

## MISCELLANEOUS FITTINGS

### 183.1 Adapters with Stopcock, "Labglas", Cone to Rubber Tubing, Straight/Rt. angle connection, with Stopcock.

Cat. No.	Cone	Price / Piece (Rs.)
183.1	14/23	190.00
183.2	19/26	195.00
183.3	24/29	205.00
183.4	29/32	210.00
183.5	34/35	270.00

### 184.1 Adapters, "Labglas", Cone to rubber tubing, straight/Rt. angle connection.

Cat. No.	Cone	Price / Piece (Rs.)
184.1	14/23	59.00
184.2	19/26	69.00
184.3	24/29	70.00
184.4	29/32	85.00
184.5	34/35	120.00

### 185.1 Adapters, "Labglas", Cone with stem, rubber tubing Right angle connection.

Cat. No.	Cone	Price / Piece (Rs.)
185.1	14/23	94.00
185.2	19/26	104.00
185.3	24/29	110.00

### 186.1 Adapters "Labglas", Socket to cone with Tee Connection.

Cat. No.	Socket	Cone	Price / Piece (Rs.)
186.1	14/23	19/26	19/26
186.2	19/26	19/26	19/26
186.3	19/26	24/29	24/29
186.4	24/29	34/35	34/35

### 187.1 Drying Tube, "Labglas".

Cat. No.	Cone	Price / Piece (Rs.)
187.1	14/23	80.00
187.2	19/26	89.00
187.3	24/29	105.00

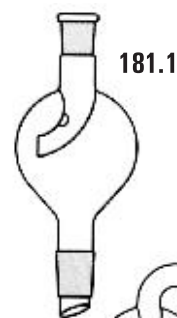

181.1

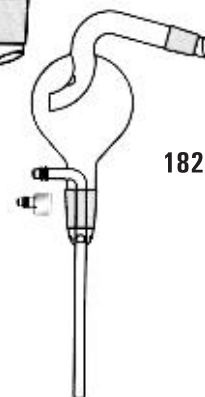

182.1

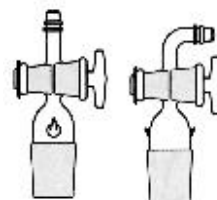

183.1

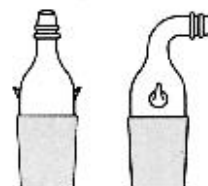

184.1



185.1

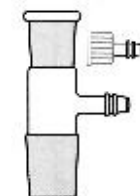

186.1



187.1

### 188.1 Thermometer Pocket, "Labglas".

Cat. No.	Cone	Price / Piece (Rs.)
188.1	14/23	75.00
188.2	19/26	85.00
188.3	24/29	95.00

### 189.1 Air Leak Tube/Gas Inlet Tube, "Labglas".

Cat. No.	Cone	Price / Piece (Rs.)
189.1	14/23	86.00
189.2	19/26	89.00
189.3	24/29	98.00
189.4	34/35	125.00

## STIRRERS

### 190.1 Teflon Bladed Stirrers, "Labglas", Blade removable from the Stirrer Shaft.

Cat. No.	Approx. Shaft Dia mm	Shaft Length mm	Smallest Socket through which blade will pass	Blade Width mm	Price / Piece (Rs.)
190.1	6	450	19/26	52	245.00
190.2	6	450	24/29	76	305.00
190.3	8	450	24/29	76	315.00
190.4	8	450	29/32	100	410.00
190.5	8	600	34/35	100	420.00
190.6	10	450	34/35	100	425.00
190.7	10	600	34/35	125	570.00
190.8	10	600	50/42	150	690.00

## SEPARATING/DROPPING FUNNELS

### 191.1 Separating Funnels, "Labglas", with glass key Stopcock, Interchangeable Stopper, Conical/Pear Shape, Plain Stem.

Cat. No.	Capacity ml.	Price / Piece (Rs.)
191.1	25/30	205.00
191.2	50/60	275.00
191.3	100/125	395.00
191.4	250	375.00
191.5	500	580.00
191.6	1000	890.00
191.7	2000	1875.00

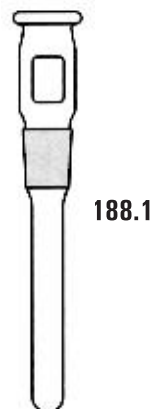

188.1



189.1



190.1



191.1

## Separating / Dropping Funnels

**192.1 Separating Funnels, "Labglas", with Screw type. PTFE Needle Valve stopcock. Interchangeable Stopper Conical/Pear Shape, Plain Stem.**

Cat. No.	Capacity ml.	Price / Piece (Rs.)
192.1	25/30	235.00
192.2	50/60	265.00
192.3	100/125	355.00
192.4	250	455.00
192.5	500	565.00
192.6	1000	905.00
192.7	2000	1750.00

**193.1 Separating Funnels, "Labglas", with PTFE key Stopcock, Interchangeable Stopper, Conical/Pear Shape, Plain Stem.**

Cat. No.	Capacity ml.	Price / Piece (Rs.)
193.1	25/30	495.00
193.2	50/60	570.00
193.3	100/125	665.00
193.4	250	745.00
193.5	500	990.00
193.6	1000	1340.00
193.7	2000	2175.00

**194.1 Separating Funnels, "Labglas", with glass key Stopcock, Interchangeable Stopper, Globe Shape, Plain Stem.**

Cat. No.	Capacity ml.	Price / Piece (Rs.)
194.1	25/30	215.00
194.2	50/60	245.00
194.3	100/125	305.00
194.4	250	385.00
194.5	500	485.00
194.6	1000	795.00
194.7	2000	1365.00
194.8	3000	2390.00
194.9	5000	3540.00
194.10	10000	7150.00
194.11	20000	11650.00

**195.1 Separating Funnels, "Labglas", with Screw type PTFE Needle Valve Stopcock, Interchangeable Stopper, Globe Shape, Plain Stem.**

Cat. No.	Capacity ml.	Price / Piece (Rs.)
195.1	25/30	205.00
195.2	50/60	240.00
195.3	100/125	290.00
195.4	250	380.00
195.5	500	475.00
195.6	1000	805.00
195.7	2000	1530.00

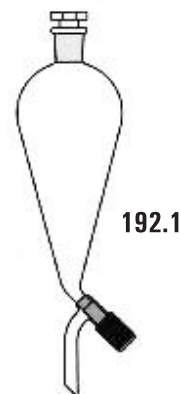

192.1



193.1

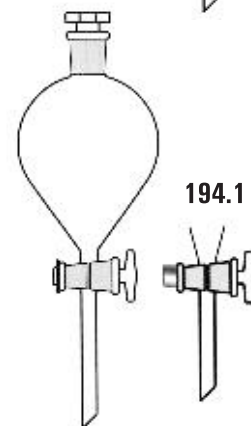

194.1



195.1





**196.1 Separating Funnels, "Labglas", with PTFE key Stopcock, Interchangeable Stopper, Globe Shape, Plain Stem.**

Cat. No.	Capacity ml.	Price / Piece (Rs.)
196.1	25/30	440.00
196.2	50/60	450.00
196.3	100/125	520.00
196.4	250	660.00
196.5	500	875.00
196.6	1000	1225.00
196.7	2000	2025.00



196.1

**197.1 Dropping Funnels, "Labglas", Cylindrical, with Interchangeable Stopper and Glass Key/Screw type PTFE Stopcock, Plain Stem.**

Cat. No.	Capacity ml.	Price / Piece (Rs.)	
		Glass Key S/C	Screw Type PTFE S/C
197.1	50	250.00	250.00
197.2	100	275.00	275.00
197.3	250	365.00	365.00

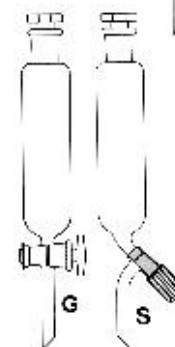

197.1

**198.1 Dropping Funnels, "Labglas", Cylindrical, Graduated, with I/C Stopper and Glass Key/Screw type PTFE Stopcock, Plain Stem.**

Cat. No.	Capacity ml.	Price / Piece (Rs.)	
		Glass Key S/C	Screw Type PTFE S/C
198.1	50	305.00	305.00
198.2	100	345.00	345.00
198.3	250	495.00	495.00

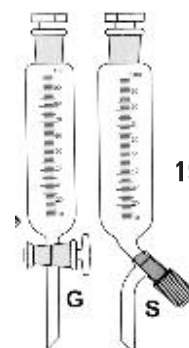

198.1

**199.1 Dropping Funnels, "Labglas", Cylindrical, open top, with Glass Key/Screw type PTFE Stopcock, Stem with Cone.**

Cat. No.	Capacity ml.	Cone	Price / Piece (Rs.)	
			Glass Key S/C	Screw Type PTFE S/C
199.1	50	19/26	215.00	215.00
199.2	100	19/26	295.00	295.00
199.3	100	24/29	305.00	305.00
199.4	250	19/26	405.00	405.00
199.5	500	24/29	495.00	495.00

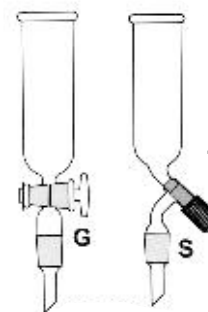

199.1

**200.1 Separating Funnels, "Labglas", Pear shape, with socket, Glass Key/Screw Type PTFE stopcock, stem with cone but without stopper.**

Cat. No.	Capacity ml.	Socket Size	Cone Size	Price / Piece (Rs.)	
				Glass Key S/C	Screw Type PTFE S/C
200.1	50	14/23	14/23	315.00	315.00
200.2	50	19/26	19/26	320.00	320.00
200.3	100	19/26	19/26	365.00	365.00
200.4	250	19/26	19/26	415.00	415.00
200.5	500	19/26	19/26	530.00	530.00
200.6	500	24/29	24/29	545.00	545.00

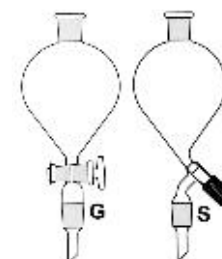

200.1

**201.1 Dropping Funnels, "Labglas", Cylindrical, with socket, Glass Key/Screw type PTFE stopcock, stem with cone but without stopper.**

Cat. No.	Capacity ml.	Socket Size	Cone Size	Price/Piece (Rs.) Glass Key S/C	Price / Piece (Rs.) Screw Type PTFE S/C
201.1	50	14/23	14/23	290.00	290.00
201.2	50	19/26	19/26	305.00	305.00
201.3	100	19/26	19/26	325.00	325.00
201.4	250	19/26	19/26	435.00	435.00

**202.1 Pressure Equalizing Funnels, "Labglas", Pear shape, with socket, Glass key / PTFE Key stopcock, stem with cone.**

Cat. No.	Capacity ml.	Socket Size	Cone Size	Price/Piece (Rs.) Glass Key S/C	Price / Piece (Rs.) PTFE Key S/C
202.1	100	19/26	19/26	560.00	750.00
202.2	100	24/29	24/29	565.00	765.00
202.3	250	19/26	19/26	575.00	805.00
202.4	250	24/29	24/29	585.00	820.00
202.5	500	19/26	19/26	730.00	965.00
202.6	500	24/29	24/29	730.00	975.00

**203.1 Pressure Equalising Funnels, "Labglas", Cylindrical, with socket, Glass key/PTFE key stopcock, stem with cone.**

Cat. No.	Capacity ml.	Socket Size	Cone Size	Price/Piece (Rs.) Glass Key S/C	Price / Piece (Rs.) PTFE Key S/C
203.1	50	19/26	19/26	425.00	675.00
203.2	100	19/26	19/26	495.00	695.00
203.3	250	19/26	19/26	595.00	810.00
203.4	250	24/29	24/29	605.00	820.00
203.5	500	19/26	19/26	805.00	1070.00
203.6	500	24/29	24/29	815.00	1090.00

### ASSEMBLIES

**204.1 Distillation Apparatus, "Labglas", Consists of 500 ml Flask, 200 mm. Graham condenser and stopper.** 1035.00

**205.1 Distillation Apparatus, "Labglas", Consists of 2000 ml Flask, Friedrich condenser and stopper.** 2205.00

**206.1 Distillation Apparatus, "Labglas", Compact, Consists of 1000 ml Erlenmeyer Flask and Friedrich condenser.** 1755.00

**207.1 Distillation Apparatus Ammonia, "Labglas" Consists of 500 ml Kjeldahl Flask, splash head and Graham condenser.** 1215.00

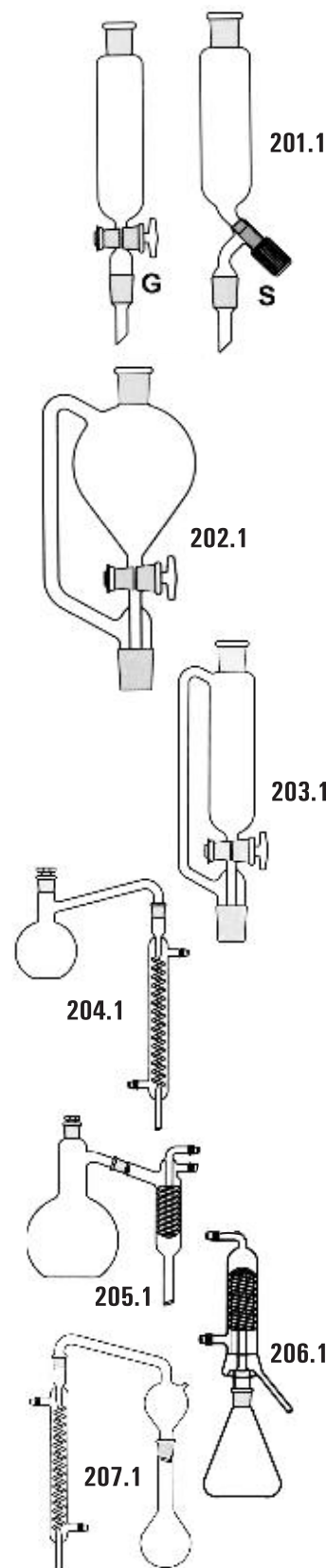

# Labglas Scientific Equipments

## Assemblies, Extractors & Distillation



208.1 Reflux Apparatus, consists of RB Flask and Air Condenser.

Cat. No.	Flask Capacity (ml.)	Air Condenser (mm)	Price / Piece (Rs.)
208.1	100	500	380.00
208.2	250	750	405.00
208.3	500	1000	415.00

209.1 Reflux Apparatus, consists of RB Flask and Liebig Condenser.

Cat. No.	Flask Capacity (ml.)	Liebig Condenser (mm)	Price / Piece (Rs.)
209.1	100	300	495.00
209.2	250	400	575.00
209.3	500	500	680.00

210.1 Distillation Assembly, "Labglas", consists of R.B. flask, recovery bend. Liebig condenser and receiver adapter.

Cat. No.	Flask Capacity (ml.)	Condenser Effective Length (mm)	Price / Piece (Rs.)
210.1	2000	200	1450.00
210.2	3000	300	2990.00
210.3	5000	400	4290.00
210.4	10000	600	7890.00

211.1 Distillation Apparatus, "Labglas", consists of R.B. flask, recovery bend, Liebig condenser and receiver adapter.

Cat. No.	Flask Capacity (ml.)	Condenser Effective Length (mm)	Price / Piece (Rs.)
211.1	250	200	695.00
211.2	500	300	845.00
211.3	1000	350	990.00
211.4	2000	400	1495.00

212.1 Kjeldahl Distillation Assembly, "Labglas", consists of Kjeldhal flask 500 ml, multiple adapter two necks, splash head verticle, Liebig condenser, receiver adapter and dropping funnel 100 ml. 1640.00

### EXTRACTORS

213.1 Soxhlet Extraction, "Labglas", consists of Flask, Extractor and Condenser.

Cat. No.	Extractor Cap. (ml)	Extractor Socket	Extractor Cone	Flask Cap. (ml)	Price / Piece (Rs.)
213.1	60	34/35	24/29	150	805.00
213.2	100	40/38	24/29	250	880.00
213.3	200	50/42	24/29	500	1240.00
213.4	400	50/42	24/29	1000	2070.00
213.5	600	50/42	24/29	2000	2475.00
213.6	1000	55/42	34/35	3000	3870.00

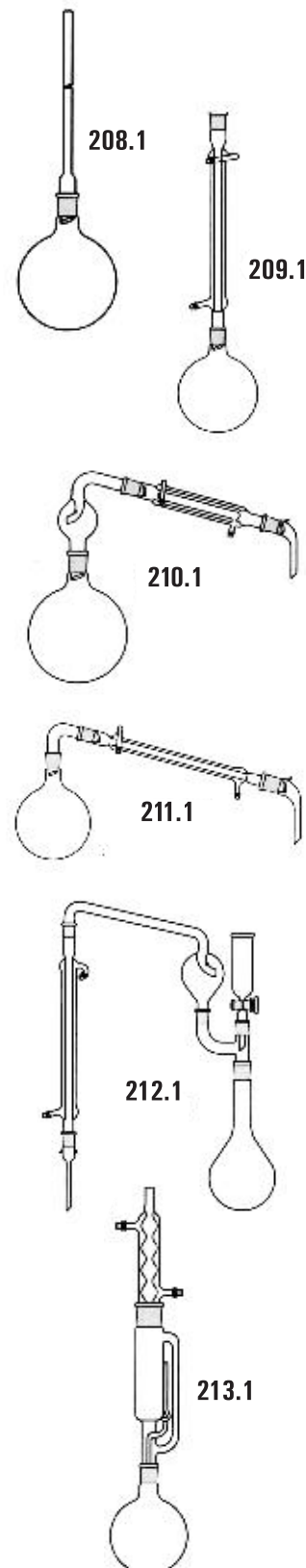

**214.1 Spare Extractor, "Labglas" for Soxhlet.**

Cat. No.	Capacity (ml)	Socket	Cone	Price / Piece (Rs.)
214.1	60	34/35	24/29	340.00
214.2	100	40/38	24/29	395.00
214.3	200	50/42	24/29	595.00
214.4	400	50/42	24/29	980.00
214.5	600	50/42	24/29	1180.00
214.6	1000	55/44	34/35	1575.00

**215.1 Soxhlet Extraction, "Labglas", consists of R.B. Flask, Extractor with flat flange, reduction adapter with flat flange and socket and double surface condenser.**

Cat. No.	Capacity (ml)	Flask Capacity (ml)	Price / Piece (Rs.)
215.1	600	2000	5355.00
215.2	1000	3000	8415.00
215.3	2000	5000	10350.00
215.4	3000	10000	14310.00

**216.1 Moisture Determination Unit, "Labglas", (Dean & Stark), comprises of round bottom flask, receiver and leibig condenser.**

Cat. No.	Type	Price / Piece (Rs.)
216.1	2 ml Receiver with stopcock, 250 ml Flask	1250.00
216.2	5 ml Receiver with stopcock, 500 ml Flask	1350.00
216.3	10 ml Receiver with stopcock, 1000 ml Flask	1390.00
216.4	25 ml Receiver with stopcock, 1000 ml Flask	1425.00
216.5	2 ml Receiver without stopcock, 250 ml Flask	990.00
216.6	5 ml Receiver without stopcock, 500 ml Flask	1050.00
216.7	10 ml Receiver without stopcock, 1000 ml Flask	1105.00
216.8	25 ml Receiver without stopcock, 1000 ml Flask	1305.00
216.9	Spare receiver with stopcock, 2/5/10/25 ml	605.00
216.10	Spare receiver without stopcock 2/5/10/25 ml	525.00

**217.1 Essential Oil Determination Unit, "Labglas" (Clevenger Type) Vertical tube combined with condenser and measuring tube with stopcock. A return tube for the aqueous part of the distillate connects the bottom of the measuring tube and the vertical tube.**

Cat. No.	Flask Capacity (ml)	Price / Piece (Rs.)
217.1	1000	1890.00
217.2	2000	2190.00
217.3	3000	3590.00
217.4	5000	4760.00
217.5	10000	8280.00
217.6	20000	14175.00

**218.1 Clevenger Assembly, "Labglas" for determination of volatile oil lighter than water, comprising of 1000 ml flask, oil separatory tube and condenser.**

- Spare Oil Separatory Tube 675.00

**219.1 Clevenger Assembly, "Labglas" for determination of volatile oil heavier than water, comprising of 1000 ml, flask, oil separatory tube and condenser.**

- Spare Oil Separatory Tube 675.00



214.1



215.1

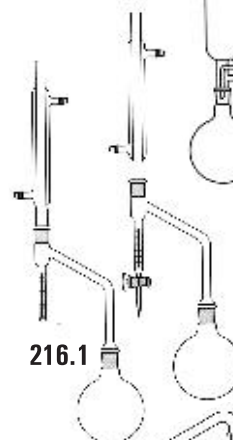

216.1



217.1

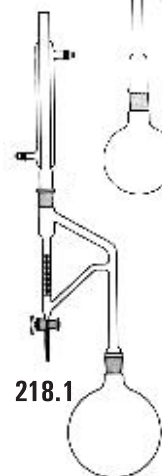

218.1

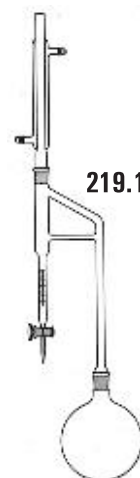

219.1

### SINTERED GLASSWARE (FILTRATION)

220.1 Crucible, "Labglas" Gooch type with Sintered Disc of Porosity G-1 or G-2 or G-3 or G-4.

Cat. No.	Capacity (ml)	Price / Piece (Rs.)
120.1	15	75.00
120.2	30	84.00
120.3	50	155.00

221.1 Adapter, "Labglas", for Gooch Crucible.

Cat. No.	Dia x Ht. (mm)	Stem (mm)	Suitable for Crucible (ml)	Price / Piece (Rs.)
221.1	31 x 60	75 x 9	15	60.00
221.2	40 x 68	75 x 9	30	65.00
221.3	47 x 78	75 x 9	50	95.00

222.1 Buchner Funnel, "Labglas", with Sintered Disc of Porosity G-1 or G-2 or G-3 or G-4, plain stem.

Cat. No.	Capacity (ml)	Disc Dia. (mm)	Price / Piece (Rs.)
222.1	35	30	150.00
222.2	80	40	245.00
222.3	200	65	505.00
222.4	500	90	1350.00
222.5	1000	120	3150.00
222.6	2000	145	8105.00

223.1 Buchner Funnel, "Labglas", with Sintered Disc of Porosity G-1 or G-2 or G-3 or G-4 cone at stem.

Cat. No.	Capacity (ml)	Disc Dia. (ml)	Cone	Price / Piece (Rs.)
223.1	35	30	14/23 or 19/26	275.00
223.2	80	40	14/23 or 19/26	405.00
223.3	200	65	19/26 or 24/29	725.00
223.4	500	90	24/29 or 29/32	1870.00
223.5	1000	120	24/29 or 29/32	4150.00
223.6	2000	145	24/29 or 29/32	9590.00

### FILTRATION

224.1 Filter Apparatus, "Labglas", Complete with Filtering Flask, gooch crucible with Sintered Disc of Porosity G-1 or G-2 or G-3 or G-4, glass adapter and rubber cone and rubber cone.

Cat. No.	Flask Capacity (ml)	Crucible Capacity (ml)	Price / Piece (Rs.)
224.1	250	30	495.00
224.2	500	30	505.00
224.3	1000	50	905.00



220.1



221.1



222.1



223.1

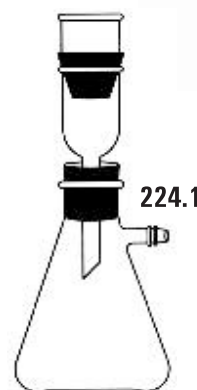

224.1

## Filtration

**225.1 Filter Apparatus, "Labglas", Complete, Filter Flask with Socket and Buchner funnel with Sintered Disc of Porosity G-1 or G-2 or G-3 or G-4, having cone at stem.**

Cat. No.	Flask Capacity (ml)	Buchner Funnel Capacity (ml)	Joint	Price / Piece (Rs.)
225.1	250	80	24/29	675.00
225.2	500	200	24/29	1025.00
225.3	1000	500	29/32	2295.00
225.4	2000	1000	29/32	5535.00

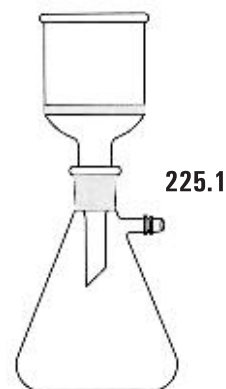

225.1

**226.1 Filtering Apparatus Witt's, "Labglas", Complete with flanged jar, flanged lid, funnel and 250 ml beaker.**

3780.00

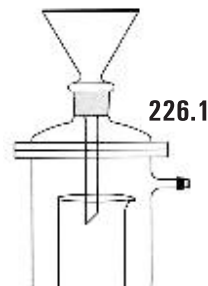

226.1

**227.1 Membrane Filter Holder Assembly, "Labglas", with support for membrane, Funnel, Flask and Clamp, Standard Joint Fitting.**

Cat. No.	Membrane dia (mm)	Funnel Capacity (ml)	Flask Capacity (ml)	Price / Piece (Rs.)
227.1	13	35	250	1750.00
227.2	25	35	500	1950.00
227.3	47	300	1000	3150.00
227.4	47	300	2000	3550.00
227.5	47	300	5000	5420.00
227.6	90	1000	5000	28005.00

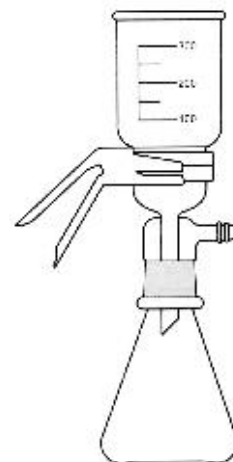

227.1 & 228.1

**228.1 Spare Flasks with Cones for 227.1.**

Cat. No.	Capacity (ml)	Cone Size	Price / Piece (Rs.)
228.1	250	24/29	415.00
228.2	500	29/32	595.00
228.3	1000	40/42	905.00
228.4	2000	40/42	1560.00
228.5	5000	40/42	3995.00

**229.1 Membrane Filter Holder Assembly, "Labglas", with support for membrane, Funnel, Flask and Clamp, Neoperene Rubber Cork fitting.**

Cat. No.	Membrane dia (mm)	Funnel Capacity (ml)	Flask Capacity (ml)	Price / Piece (Rs.)
229.1	13	35	250	1550.00
229.2	25	35	500	1750.00
229.3	47	300	1000	3050.00
229.4	47	300	2000	3350.00
229.5	47	300	5000	5200.00

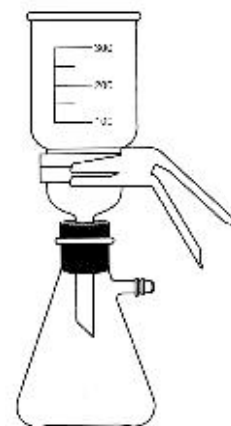

229.1

### STOPCOCKS

#### 230.1 Stopcock, "Labglas", for Straight Bore.

Cat. No.	Description	Price / Piece (Rs.)	Price / Piece (Rs.)
		Bore 1-2 (mm)	Bore 3-4 (mm)
230.1	With Solid Plug, Side Tube	80.00	150.00
230.2	With Solid Plug, Side Capillary	88.00	160.00

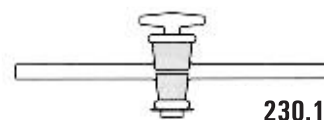

#### 231.1 Stopcock, "Labglas", for Burettes

Cat. No.	Description	Price / Piece (Rs.)
231.1	With Solid Glass Key	72.00
231.2	With PTFE Key	290.00
231.3	With PTFE Needle, Screw type	70.00

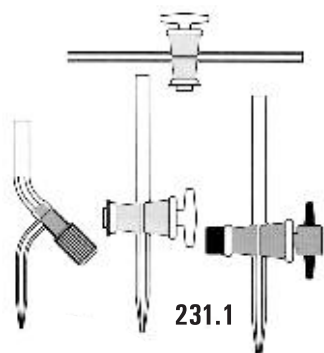

#### 232.1 Stopcock "Labglas", Screw type PTFE needle, with Two Plain limbs.

Cat. No.	Limbs O.D. (mm)	Price / Piece (Rs.)
232.1	8	70.00
232.2	10	165.00
232.3	12	225.00
232.4	15	305.00

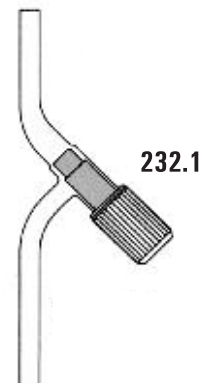

#### 233.1 Stopcock, "Labglas", Straight Bore with PTFE key

Cat. No.	Body Wide End I.D. (mm Approx)	Key Bore (mm)	Price / Piece (Rs.)
233.1	10	1	315.00
233.2	12	2	315.00
233.3	14	3	345.00
233.4	16	4	515.00
233.5	19	6	725.00
233.6	24	8	1290.00

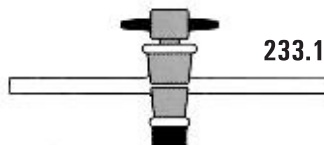

### CLINICAL LABORATORY GLASSWARE

#### 234.1 Graduated Micro Capillary Pipettes, Disposable, Calibrated "to contain"

Cat. No.	Capacity $\mu$ l.	Graduation $\mu$ l.	Colour Code	Price / 250 Piece (Rs.)
234.1	5	1,2,3,4 & 5	White	745.00
234.2	5	5	White	710.00
234.3	10	10	Orange	710.00
234.4	10	5 & 10	Orange	655.00
234.5	20	10 & 20	Black	710.00
234.6	20	20	Black	710.00
234.7	25	25	White	710.00
234.8	44	44.7	Purple	745.00
234.9	50	50	Green	710.00
234.10	100	100	Blue	710.00
234.11	200	200	Red	745.00

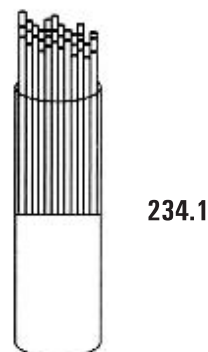

**235.1 Haematocrit Capillaries, colour Blue for Non Heparinised and Red for heparinised.**

Cat. No.	Description	Price / Piece (Rs.)
235.1	75 mm non heparinised capillary (100/vial)	82.00
235.2	75 mm heparinised capillary (100/vial)	120.00

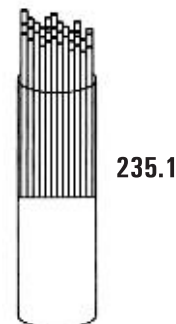

235.1

**236.1 Micro Slide : 75 x 25 mm Prepared from high quality thin glass, 1.00-1.2 mm thick, packed with Paper in between each slide and sealed in transparent P.P. Envelop, Pk. of 50.**

Cat. No.	Type	Price / Pk (Rs.)
236.1	Ground Edges	68.00
236.2	Ground Edges & one side at one end 19mm frosted Surface	95.00

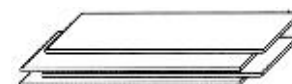

236.1

**237.1 Micro Slide : 75 x 25 mm Prepared from high quality thin glass, 1.35 mm thick, Pk. of 50.**

Cat. No.	Type	Price / Pk (Rs.)
237.1	Ground Edges	50.00
237.2	Ground Edges & one side at one end 19mm frosted Surface	75.00

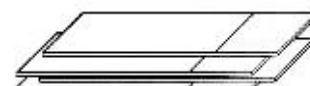

237.1

**238.1 Micro Concavity Slides : 75 x 75 x 1.45 mm, spherical concavities are 15-18 mm dia 0.5 to 0.6 mm deep, beveled and polished edges, Pk. of 10.**

Cat. No.	No. of Concavities	Price / Pk (Rs.)
238.1	One	65.00
238.2	Two	75.00
238.3	Three	85.00

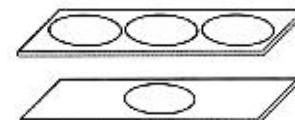

238.1

**239.1 V.D.R.L. Slides (Kline Concavity Slides) :  
75 x 56 x 3 mm, Concavities 16 mm. Dia, 1.75 mm. deep,  
Polished edges, Frosted surface. 12 concavities.**

85.00



239.1

**240.1 Blood Grouping Slides : 100 x 100 x 10 mm thick, 12 concavities of 21 mm.  
Dia x 1.5 mm. deep, frosted surface (One slide)**

265.00

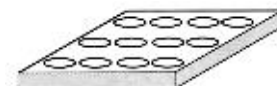

240.1

**241.1 Cover Glass No. 1 (Thickness 0.13 to 0.17 mm), Pk. of 10 gm, imported glass.**

Cat. No.	Type	Size (mm)	Price / Pk (Rs.)
241.1	Square	18 x 18	130.00
241.2	Square	22 x 22	130.00
241.3	Square	24 x 24	130.00
241.4	Rectangular	22 x 40	155.00
241.5	Rectangular	22 x 50	155.00
241.6	Rectangular	24 x 50	155.00
241.7	Haemocytometer	22 x 25 x 0.4 mm (10 Pairs)	95.00



241.1



### GAS ANALYSIS

242.1 Impinger, "Labglas", graduated, for sampling small gas volumes as per standard specification. Capacity : 35 ml 215.00

243.1 Calcium Chloride Tube, "Labglas", Straight or bent.

Cat. No.	Type	Price / Piece (Rs.)
243.1	with one bulb	23.00
243.2	with two bulbs	35.00

244.1 Calcium Chloride Tube, "Labglas", U shape.

Cat. No.	Ht. x Tube O.D. mm (approx)	Price / Piece (Rs.)
244.1	100 x 12	42.00
244.2	125 x 15	68.00
244.3	150 x 18	89.00

245.1 Calcium Chloride Tube, "Labglas", U shape with side tube.

Cat. No.	Ht. x Tube O.D. mm (approx)	Price / Piece (Rs.)
245.1	100 x 12	59.00
245.2	125 x 15	85.00
245.3	150 x 18	110.00

246.1 Calcium Chloride Tube, "Labglas", U shape with side tube and interchangeable stopper.

Cat. No.	Ht. x Tube O.D. mm (approx)	Price / Piece (Rs.)
246.1	100 x 12	280.00
246.2	125 x 15	305.00
246.3	150 x 18	315.00

247.1 Calcium Chloride Tower, "Labglas", Tubular at bottom and stopcock at top.

Cat. No.	Body O.D. x Ht. mm (approx)	Price / Piece (Rs.)
247.1	38 x 250	625.00
247.2	50 x 300	775.00
247.3	60 x 300	1125.00

248.1 Gas Collecting Tubes, "Labglas", with two three way double oblique bore stopcocks one on each side.

Cat. No.	Capacity (ml)	Price / Piece (Rs.)
248.1	100	465.00
248.2	250	595.00
248.3	500	825.00

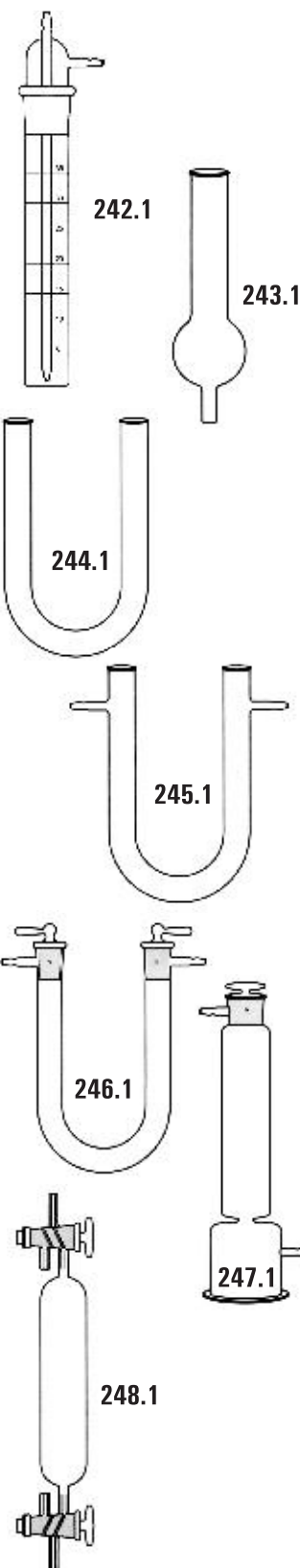



**249.1 Gas Collecting Tubes, "Labglas", with two three way double oblique bore, PTFE key stopcocks one on each side.**

Cat. No.	Capacity (ml)	Price / Piece (Rs.)
249.1	100	1350.00
249.2	250	1450.00
249.3	500	1550.00

**250.1 Gas Collecting Tubes, "Labglas", with two, two way Glass key stopcocks one on each side with side tube, screw cap and rubber septa.**

Cat. No.	Capacity (ml)	Price / Piece (Rs.)
250.1	125	375.00
250.2	250	485.00
250.3	500	645.00

**251.1 Gas Collecting Tubes, "Labglas", with two, two way PTFE key stopcocks one on each side with side tube, screw cap and rubber septa.**

Cat. No.	Capacity (ml)	Price / Piece (Rs.)
251.1	125	810.00
251.2	250	890.00
251.3	500	1090.00

**252.1 Gas Washing Bottles, "Labglas", Dreshle's type, interchangeable joints.**

Cat. No.	Capacity (ml)	Price / Piece (Rs.)
252.1	125	410.00
252.2	250	515.00
252.3	500	690.00

**253.1 Spare Head, for above gas wash bottles.  
(Please mention Bottle cap)**

230.00

**254.1 Gas Washing Bottles, "Labglas", with sintered disc, interchangeable joints.**

Cat. No.	Capacity (ml)	Price / Piece (Rs.)
254.1	125	645.00
254.2	250	745.00
254.3	500	835.00

**255.1 Spare Head, for above gas was bottles.  
(Please mention Bottle cap)**

395.00

**256.1 Gas Jar, "Labglas", with ground Glass flat flange.**

Cat. No.	Height mm (approx)	O.D. mm (approx)	Price / Piece (Rs.)
256.1	150	50	315.00
256.2	200	50	360.00
256.3	200	75	675.00
256.4	300	75	810.00

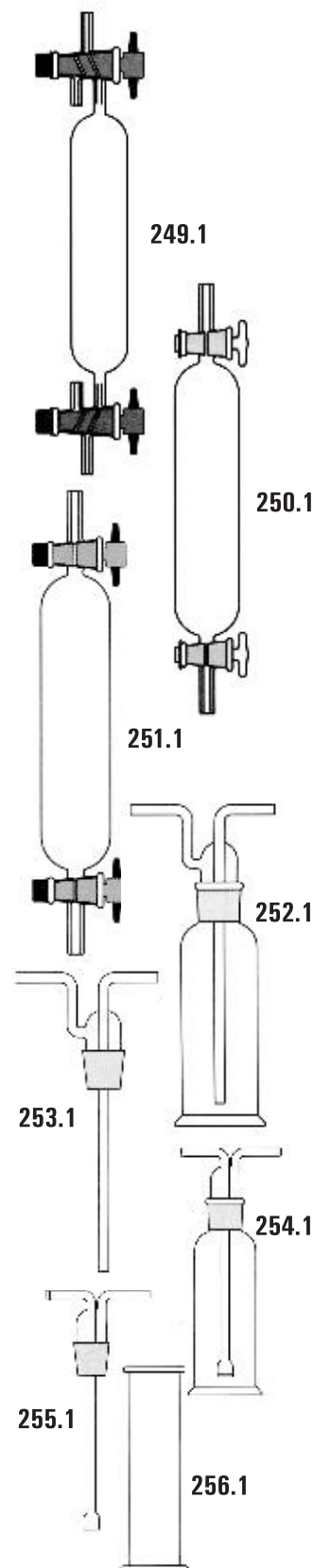

### 257.1 Gas Generator-Kipp's, "Labglas", with interchangeable joints.

Cat. No.	Capacity (ml)	Price / Piece (Rs.)
257.1	250	1935.00
257.2	500	2520.00
257.3	1000	2880.00

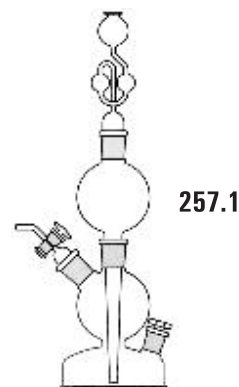

257.1

## MISC. GLASSWARE

### 258.1 Dropping Bottle, Soda glass, polythene stopper with dust proof head, glass dropper and rubber teat.

Cat. No.	Capacity (ml)	Price / Piece (Rs.)
258.1	30	72.00
258.2	60	85.00
258.3	120	95.00

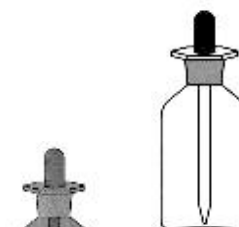

258.1

### 259.1 Dropping Bottle, Soda glass, Amber colour, polythene stopper with dust proof head, glass dropper and rubber teat.

Cat. No.	Capacity (ml)	Price / Piece (Rs.)
259.1	30	105.00
259.2	60	110.00
259.3	120	120.00



259.1

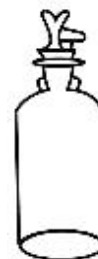

260.1

### 260.1 Dropping Bottle, T.K. Pattern Soda glass with grooved stopper.

Cat. No.	Capacity (ml)	Price / Piece (Rs.)
260.1	30	70.00
260.2	60	80.00
206.3	120	110.00

### 261.1 Dropper, with capillary jet and rubber teat.

Cat. No.	Description	Price / Piece (Rs.)
261.1	5 cm with 5 cm jet	15.00
261.2	8 cm with 10 cm jet	17.00



261.1



262.1

### 262.1 Dropper, with rubber teat 15 cm. 15.00

### 263.1 Watch Glass

Cat. No.	Dia. (mm)	Price / Piece (Rs.)
263.1	50	8.50.00
263.2	62	12.50.00
263.3	75	15.20.00
263.4	100	21.50.00



263.1

### 264.1 Stirring Rod, Glass

Cat. No.	Dia. x Length (mm)	Price / Piece (Rs.)
264.1	6 x 150	8.00
264.2	6 x 200	10.00
264.3	8 x 200	14.00
264.4	8 x 250	15.00

### 265.1 Thiele's Melting Point Tubes, "Labglas".

Cat. No.	Size (mm)	Price / Piece (Rs.)
265.1	150 x 18	56.00
265.2	150 x 25	62.00

### 266.1 Viscometer, "Labglas", Ostwald, standard size, College Pattern, Centre support.

Cat. No.	Time	Price / Piece (Rs.)
266.1	Standard	115.00
266.2	80 - 100 Sec.	140.00
266.3	100 - 120 Sec.	140.00

267.1	Stalganometer, "Labglas" Straight / Bent, graduated.	80.00
	Stalganometer Straight with Screw type PTFE Needle Stopcock.	170.00
	Stalganometer Bend, Graduated.	95.00
	Stalganometer Set of 3 (one straight, 2 bend)	475.00

### 268.1 Pyknometers, "Labglas".

Cat. No.	Capacity (ml)	Price / Piece (Rs.)
268.1	5	51.00
268.2	10	54.00
268.3	25	89.00

### 269.1 Filter Tubes, "Labglas", with side tube.

Cat. No.	Tube Size (mm)	Price / Piece (Rs.)
269.1	100 x 12	22.00
269.2	125 x 15	25.00
269.3	150 x 18	30.00
269.4	150 x 25	37.00

### 270.1 Filter Pump, "Labglas".

Cat. No.	Description	Price / Piece (Rs.)
270.1	University Pattern.	95.00
270.2	Edward's type heavy pattern, Brass.	565.00

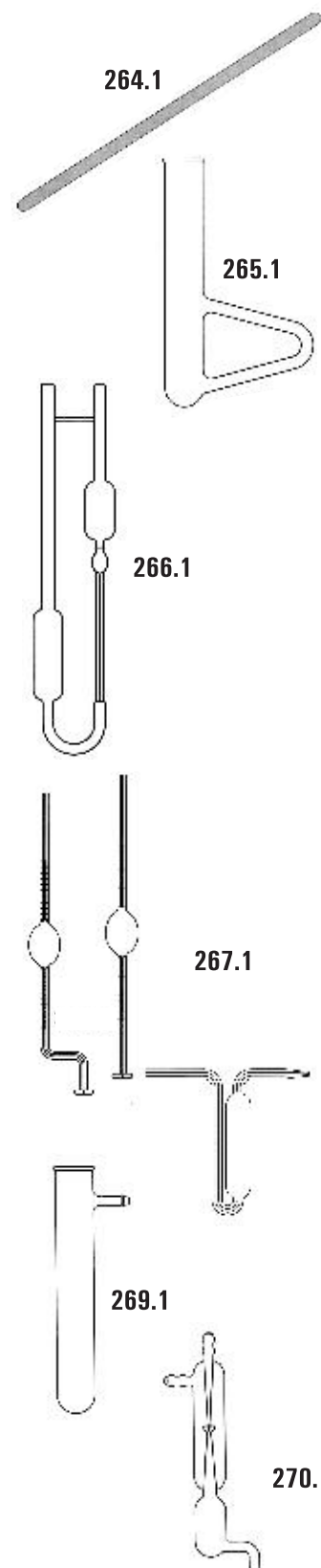

271.1 Dissolution Bowl, Clear, "Labglas". 1790.00

272.1 Dissolution Bowl, Amber, "Labglas". 2740.00

273.1 Sampling Tube (Dip Tube) 1 meter long, Dia 19mm, Heavy wall 440.00

274.1 Schoinger Micro Combustion Flask, "Labglas", (Oxygen Flask) with Platinum wire gauge sample carrier, for determination of Halogens, Sulphur, Phosphorous metal, etc. 17990.00

275.1 Practicle Size Determination Pipette "Labglas", (Sedimentation Pipette, Anderson) 1640.00

276.1 Dirt Correction, "Labglas", 1000 ml. with stopcock

Cat. No.	Description	Price / Piece (Rs.)
276.1	Plain	1340.00
276.2	Graduated	1540.00

277.1 Weighing Scoops, "Labglas", with open tubular arm, nominal capacity 3 ml or 6 ml or 10 ml. 130.00

278.1 Hoffman's Voltmeter, "Labglas", to demonstrate that H<sub>2</sub>O consists of two volumes of Hydrogen and one volume of Oxygen, with two 50 ml. Graduated limbs with stopcocks, central limb with reservoir and removable platinum electrodes.

Cat. No.	Description	Price / Piece (Rs.)
278.1	Complete Set without stand and clamps	790.00
278.2	Platinum Electrodes (Pair)	240.00
278.3	Carbon Electrodes (Pair)	70.00
278.4	Stand & Clamp for above	890.00

279.1 Conductivity Cell, "Labglas", Dip type with two rectangular electrodes parallel in a vertical plane, with 0.5 cell constant. 1190.00

280.1 pH Meter combined electrode, glass. 1010.00



271.1

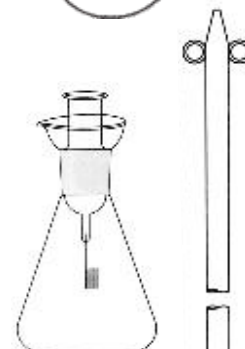

273.1

274.1

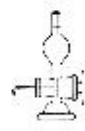

275.1

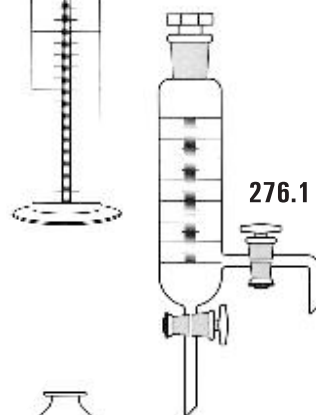

276.1

277.1

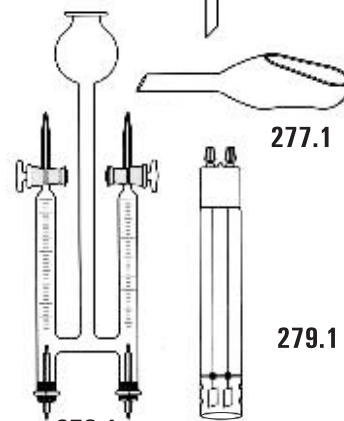

278.1

279.1

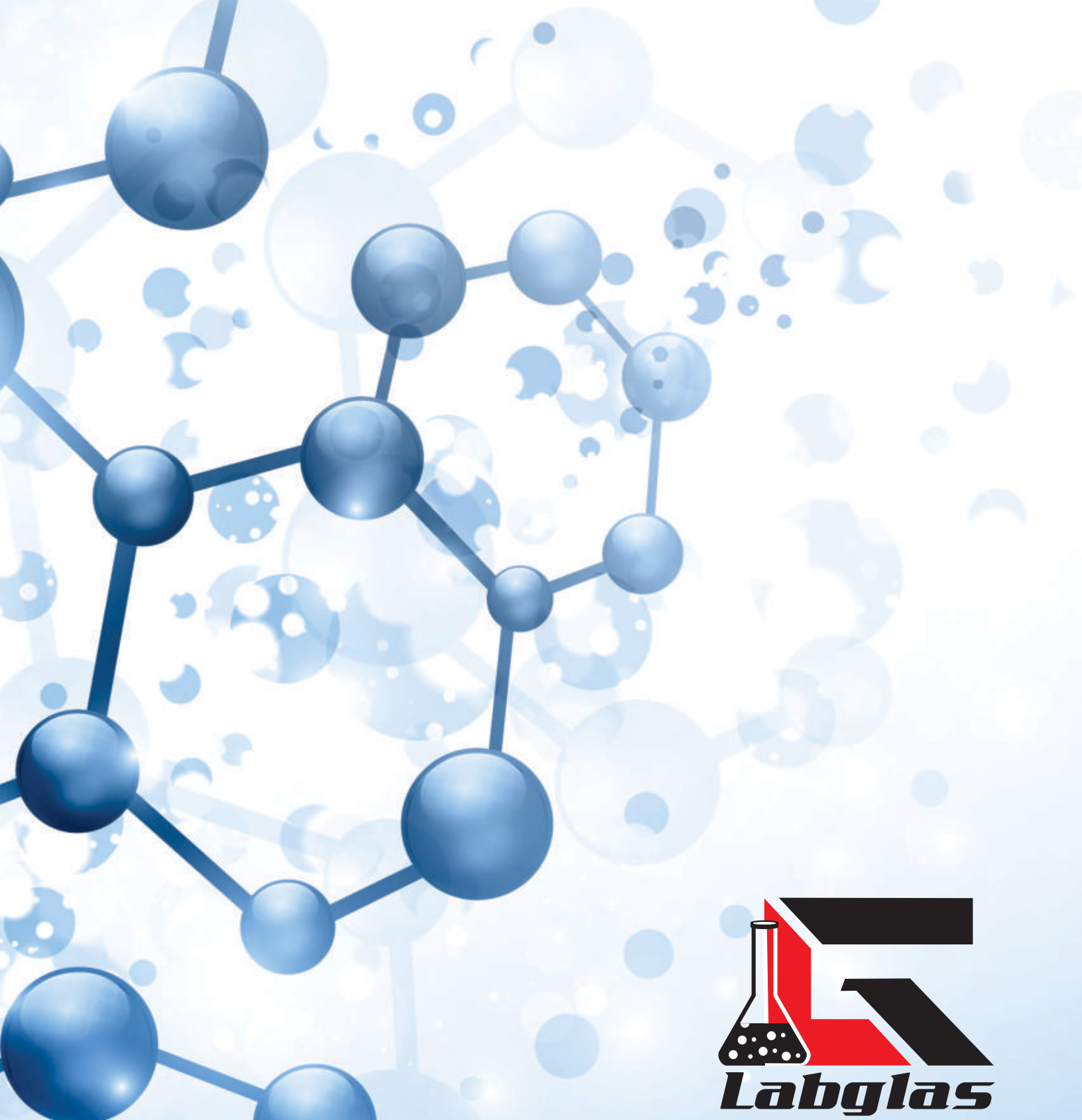

## ***Labglas Scientific Equipments***

**Corporate office : 7/51, Nirmal Bhawan, Sarsehari Road,  
Ambala Cantt. (Haryana) 133001, INDIA**

**Off. Phone : 0171-2893828, Cell : 9802888828, 808111155**

**E-mail : [labglas22@gmail.com](mailto:labglas22@gmail.com), [labglass22@gmail.com](mailto:labglass22@gmail.com)**