

# PRODUCT CATALOG

20  
24

MFG.  
SIVIK ENTERPRISE  
RAJKOT

## BLACK COLLECTION

PEARL | CORAL | RUBY

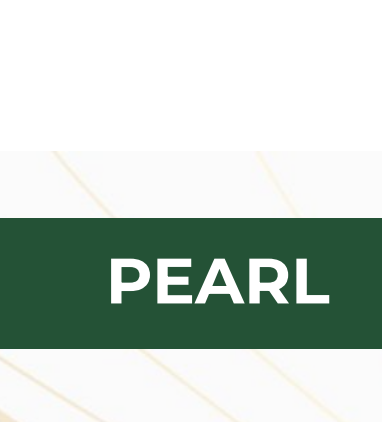
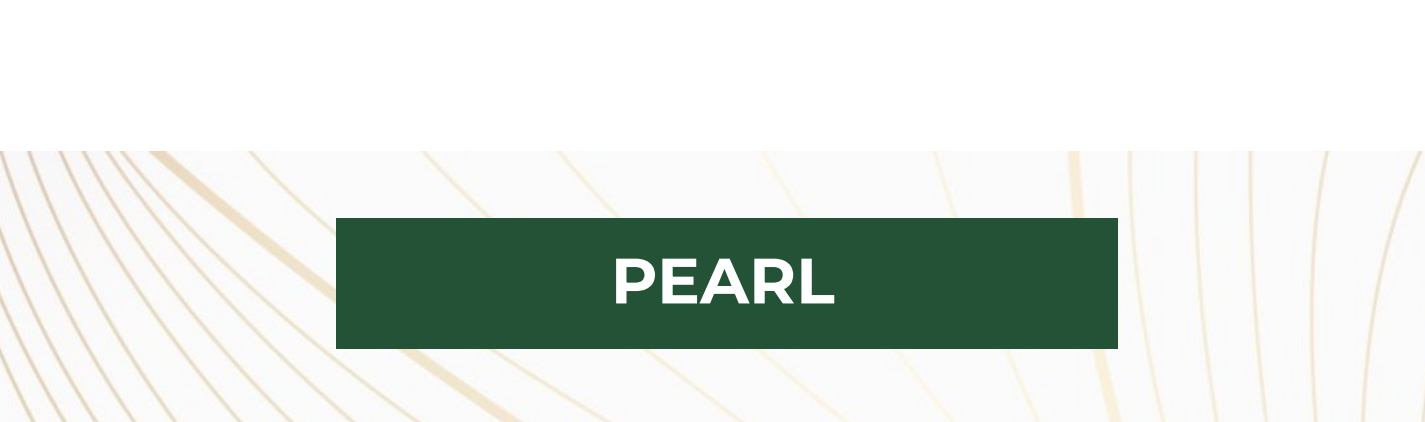

### PEARL

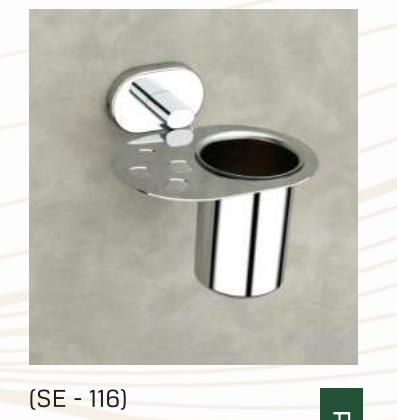
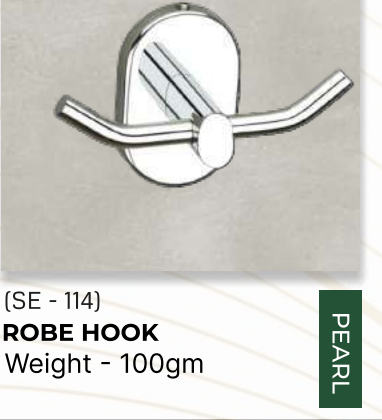

### CORAL

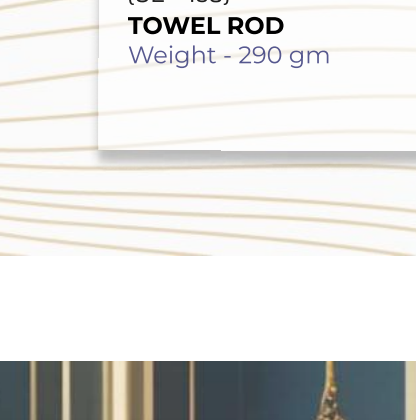
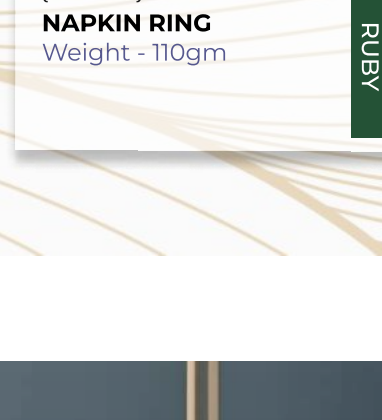
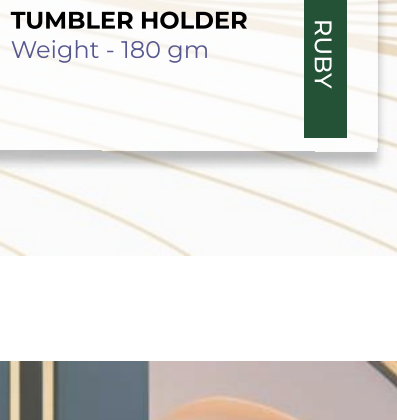
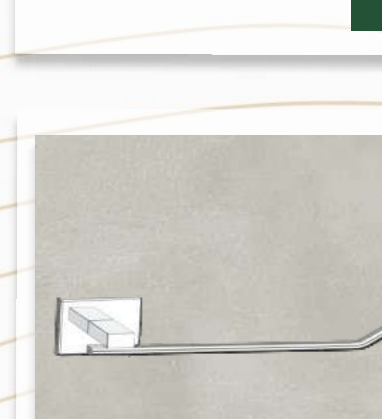
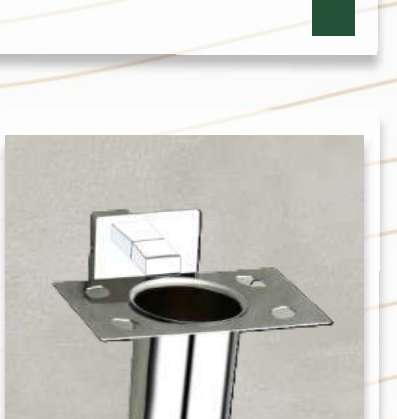
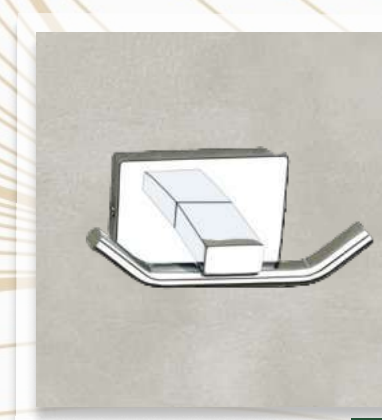

### RUBY

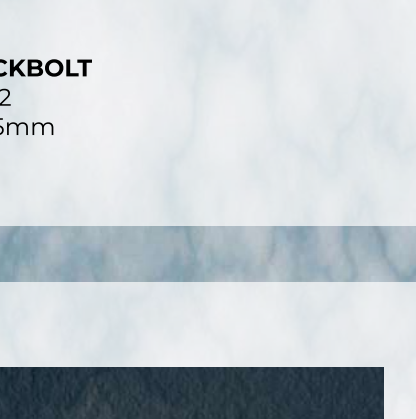
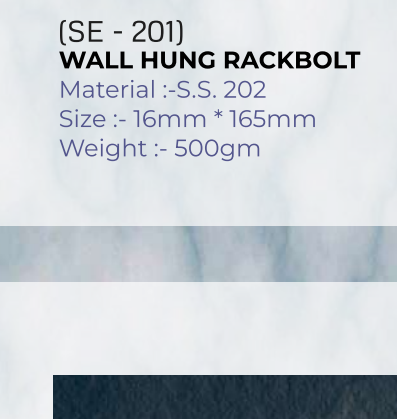
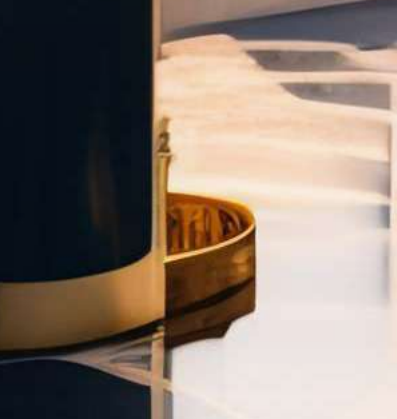

## Luxury unimagined

### RACKBOLT & FLOOR DRAIN

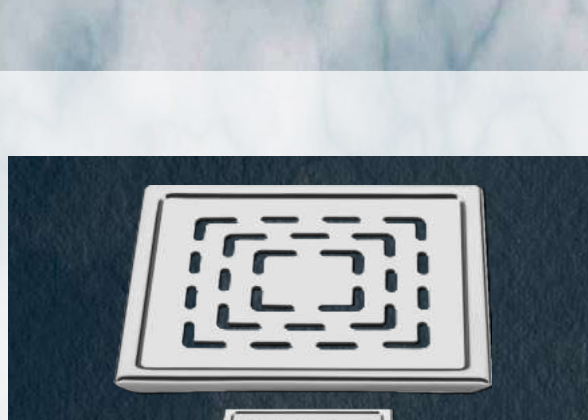
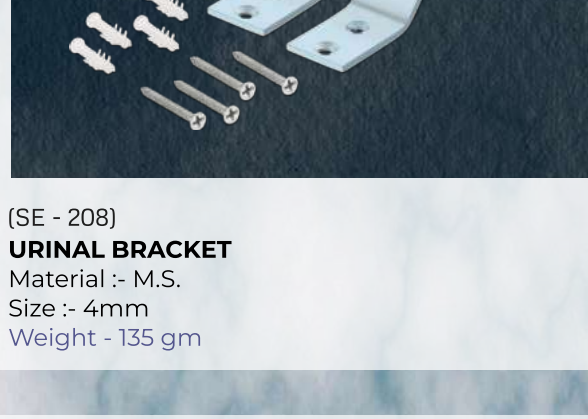
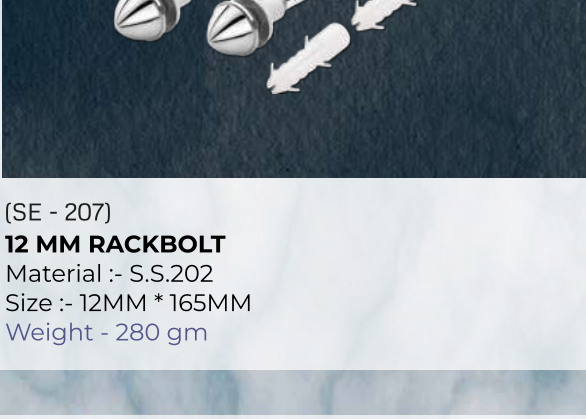
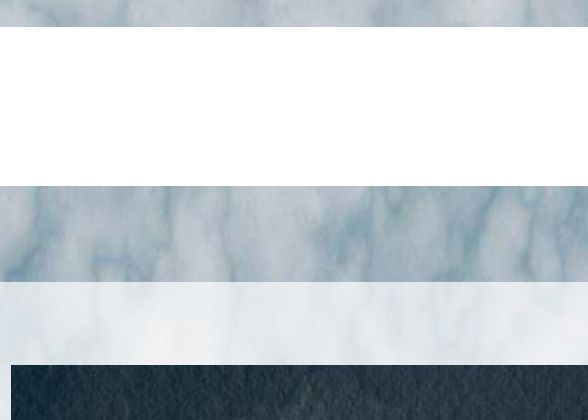
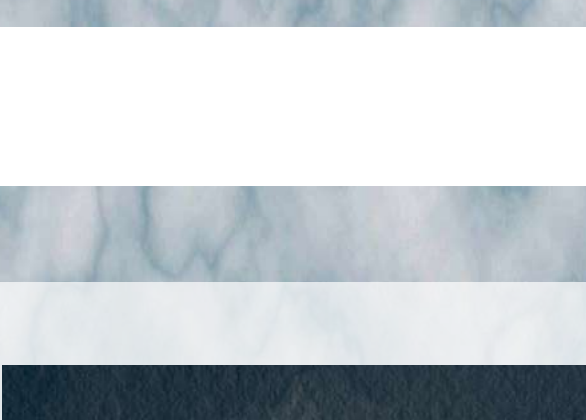

### SHOWER ARM & FRP MANHOLE COVER

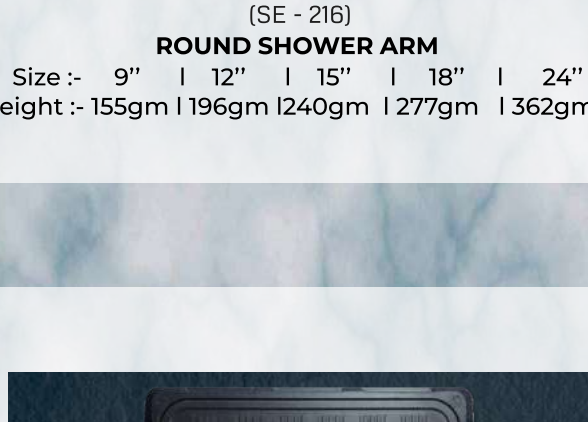

### ABOUT US

Welcome to SIVIK ENTERPRISE where precision meets excellence in

manufacturing and supply. Renowned for our commitment to

uncompromising quality, we specialize in crafting top-tier products for a

diverse range of industries. Our expertise extends beyond our branded

offerings, as we proudly offer contract manufacturing services, ensuring your

vision is brought to life with the utmost precision.

At SIVIK ENTERPRISE we also excel in white labeling, empowering businesses

to establish their brand identity effortlessly. With cutting-edge facilities and

a dedication to perfection, we are your trusted partner for high-quality

manufacturing, flexible contract solutions, and seamless white labeling

services. Elevate your products with SIVIK ENTERPRISE where quality meets

innovation.