

www.fluconenterprises.com
www.flucon.co.in



WE MANUFACTURE :

- CABLE ACCESSORIES.
- CONTROL PANEL ACCESSORIES.
- CONSTRUCTION HARDWARE.
- CUSTOMIZED INDUSTRIAL PLASTIC PRODUCTS.



Plot No.A-112, M I D C Phase -I, Road No.5 & 7,
Dombivli (East), Thane-421 203.
Tel : +91-251-2470121/+91-7666789225,+91-7498883299, +91-9323318780.
Skype Calling : flucon1
www.fluconenterprises.com/www.flucon.co.in
E mail: fluconenterprises@gmail.com, dylan@flucon.co.in

SALES DIVISION
Mob:+91-7666914987
+91-9004630767
E-mail: sales@flucon.co.in
fluconsales@gmail.com.

AUTHORISED DISTRIBUTOR / DEALER



Powering
Your
Imagination

www.fluconenterprises.com
www.flucon.co.in



An ISO 9001:2008 Company

Catalogue cum Price List w.e.f. 1st February 2016.



CORPORATE OFFICE



FINISHING DEPARTMENT



MOULDING SHOP



FLEXIBLE CABLE GLANDS

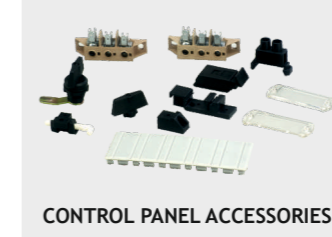

CONTROL PANEL ACCESSORIES



POLYAMIDE TOUGHENED CONDUIT PIPES



NEUTRAL LINK & BASES



PVC / RUBBER GROMMETS & CLOSURES



STAINLESS STEEL CABLE FASTENERS



SECURITY SEALS

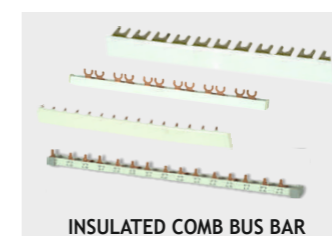

INSULATED COMB BUS BAR



METER INSPECTION WINDOW GLASS



SPACERS



HOLE BLANKING PLUG



FLEXIBLE CONDUIT PIPE GLANDS



NYLON FACED SOFT BLOW HAMMERS



DYLO-GRIP BRAND PVC RAWAL PLUG



NEUTRAL BREAKS & CONNECTORS



PLASTIC DUST CAPS

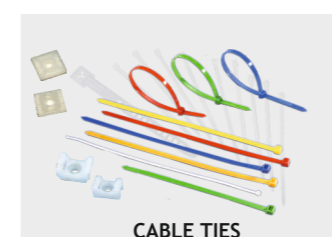

CABLE TIES



DYLO-GRIP BRAND PVC RAWAL PLUG





Tags & Security seals.

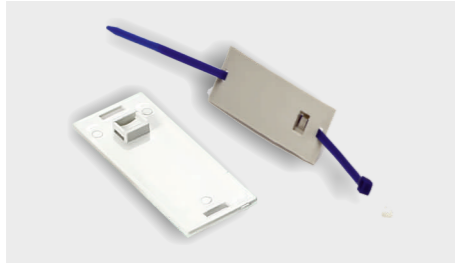

Universal Tag- Size- 65x25mm
List Price: Nylon- Rs. 253.00 per 100 pcs.
PP - Rs. 168.00 per 100 pcs

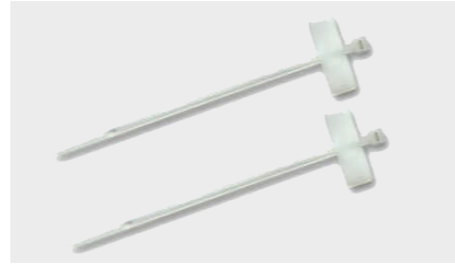

Tag-Tie - 100x2.5 - Rs.124.00 Per 100 Pieces.

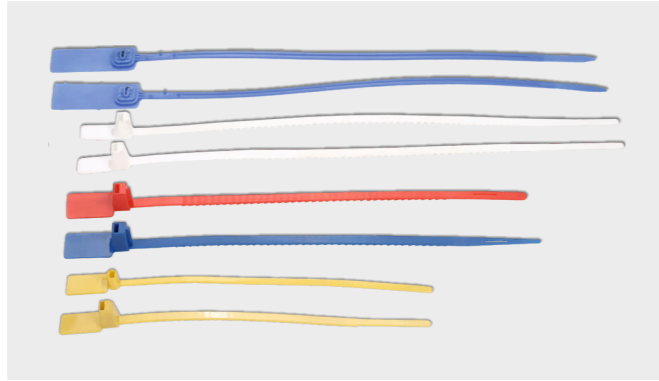

Security Seals in Nylon

Table with columns: Product code, List Price Natural/Black Colour Per Pieces, Tie Size (L, W), Lable Printable Embossing Area (L, W). Rows include FCSS-200x4.5, FCSS-200x6.9, FCSS-300x7.4, FCSS-350x6.9, FCSS-350x7.0.

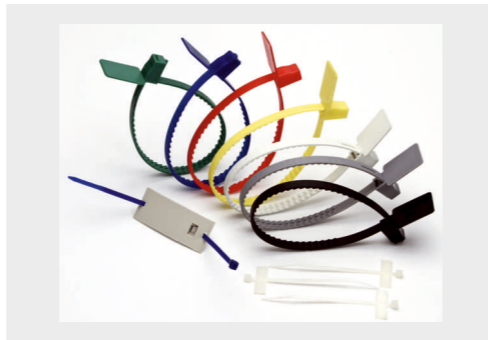

TCR Engineering Services PVT. LTD. TEST CERTIFICATE. TEST CERTIFICATE No: AP / 7910. Dated: 28.05.2012. Page 01 of 03. ISSUED TO: FLU-CON ENTERPRISES. TEST DATE: 30.04.2012. TEST LOCATION: TCR Engg. Services Pvt. Ltd., Mahape, Navi Mumbai. PARTY'S REFERENCE: Lt. Dt. 11.04.2012. TEST INSTRUMENT: PORTABLE XRF SPECTROMETER, MODEL INNOV - X. TEST PURPOSE: TO SCREEN FOR ROHS REQUIREMENTS.

TCR Engineering Services PVT. LTD. TEST CERTIFICATE. TEST CERTIFICATE No: AV 6983-92. Dated: 08.10.2013. Page 01 of 01. ISSUED TO: FLUCON COMPONENTS PVT.LTD., DOMBIVLI. TEST DATE: 8.10.2013. TEST LOCATION: TCR Engg. Services Pvt. Ltd., Mahape, Navi Mumbai. PARTY'S REFERENCE: Lt.Dt.: 19.09.2013. TEST METHOD: With Reference to IEC-62321/Ed.1.0/2008-12. TEST INSTRUMENT: PORTABLE XRF SPECTROMETER, MODEL INNOV - X. TEST PURPOSE: TO SCREEN FOR ROHS REQUIREMENTS.

TCR Engineering Services PVT. LTD. TEST CERTIFICATE. TEST CERTIFICATE No: AP / 7910-A. Dated: 28.05.2012. Page 01 of 01. ISSUED TO: FLU-CON ENTERPRISES. TEST DATE: 30.04.2012. TEST LOCATION: TCR Engg. Services Pvt. Ltd., Mahape, Navi Mumbai. PARTY'S REFERENCE: Lt. Dt. 11.04.2012. TEST INSTRUMENT: PORTABLE XRF SPECTROMETER, MODEL INNOV - X. TEST PURPOSE: TO SCREEN FOR ROHS REQUIREMENTS.

TCR Engineering Services PVT. LTD. TEST CERTIFICATE. TEST CERTIFICATE No: AP / 7910-E. Dated: 28.05.2012. Page 01 of 02. ISSUED TO: FLU-CON ENTERPRISES. TEST DATE: 30.04.2012. TEST LOCATION: TCR Engg. Services Pvt. Ltd., Mahape, Navi Mumbai. PARTY'S REFERENCE: Lt. Dt. 11.04.2012. TEST INSTRUMENT: PORTABLE XRF SPECTROMETER, MODEL INNOV - X. TEST PURPOSE: TO SCREEN FOR ROHS REQUIREMENTS.





DYLO GRIP Brand Rawal Plug

Material :- HD Polymer.
Colour :- Grey & White.
Pull Load Tested.

HDPE MATERIAL-GREY COLOUR-OPEN TYPE

Sr. No.	Item No.	List price per 100 Nos	Length	Drill Size		Punch	Screw size
				mm	Inch		
1.	DG-8x25	19.00	25 mm	4.7	3/16	8 No.	6/8
2.	DG-10x30	24.00	25 mm	6.3	1/4	10No.	8/10
3.	DG-10x45	38.00	45 mm	6.3	1/4	10No.	8/10
4.	DG-12x50	78.00	45 mm	7.9	5/16	10No.	10/12
5.	DG-14x50	112.00	50 mm	7.9	5/16	10No.	10/12
6.	DG-14x80	235.00	80 mm	12.7	1/2	12No.	14



HDPE MATERIAL-WHITE COLOUR-ROUND HEAD TYPE.

Sr. No.	Item No.	List price per 100 Nos	Length	Drill Size		Punch	Screw size
				mm	Inch		
1.	GT-8x25	33.00	25 mm	4.7	3/16	8 No.	6/8
2.	GT-10x30	46.00	25 mm	6.3	1/4	10No.	8/10
3.	GT-10x45	68.00	45 mm	6.3	1/4	10No.	8/10
4.	GT-12x50	118.00	45 mm	7.9	5/16	10No.	10/12
5.	GT-14x50	184.00	50 mm	7.9	5/16	10No.	10/12
6.	GT-14x80	295.00	80 mm	12.7	1/2	12No.	14



HDPE MATERIAL-LIGHT GREY COLOUR-RAL 7025-MFS TYPE

Sr. No.	Item No.	List price per 100 Nos	Length	Drill Size		Punch	Screw size
				mm	Inch		
1.	FCMFS-8	36.00	25 mm	4.7	3/16	8No.	6/8
2.	FCMFS-10	44.00	25 mm	6.3	1/4	10No.	8/10
3.	FCMFS-14	156.00	50 mm	7.9	5/16	10No.	10/12

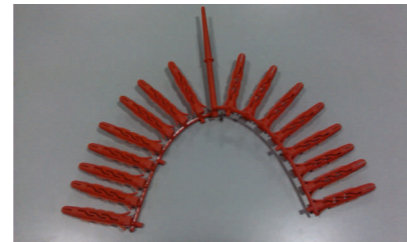

NYLON MATERIAL - RED/BLACK COLOUR

Sr. No.	Item No.	List price per 100 Nos	Length	Drill Size		Punch	Screw size
				mm	Inch		
1.	FCNA-8x60	350.00	60 mm	7.9	5/16	10No.	10/12



WIRE FIXING NAIL CLIP

Product Code: FCNCW -02-6mm
FCNCW -03-8mm
Material :- PP/MS

Flu-con Nail clip are versatile and can be used for fixing of 6/8 mm wire to wooden or masonry structures. They are easy to use and can be used in most environment conditions.

List price : Rs.60/- With wooden nail
Rs.90/- With Hardened nail.

SELF LOCKING NYLON CABLE FASTENERS

Material: Nylon 6.6 UL Certified 94V-2
Operating Temperature: Static: -10°C to 120°C.
Colors : Natural, Black, Blue, Red, Grey, Customized Colors.
Manufactured & Tested as per international standard
" BS EN 62275 FOR CABLE MANAGEMENT SYSTEM "

Prices for UV weather proof cable ties will be 25% additional.
Prices for colored cable ties will be 15% additional.

PRODUCT CODE	LIST PRICE NATURAL & BLACK COLOR	L		Bundle Dia.		Min. Loop Tensile Strength			Packing Per Packet 100 Nos.	Min. Packing Per Carton Pkt
		IN	MM	Min.	Max.	lbs	Kgs	Newton		
FCCT-100x1.8	22.00	4	100	3	24	18	8	78.45	100	650
FCCT-65x2.0	21.00	2.5	65	3	10	18	8	78.45	100	1000
FCCT-80x2.0	24.00	3.2	80	3	18	18	8	78.45	100	800
FCCT-100x2.0	26.00	4	100	3	24	18	8	78.45	100	650
FCCT-100x2.5	30.00	4	100	5	24	22	10	98.07	100	600
FCCT-150x2.5	42.00	6	150	5	35	22	10	98.07	100	350
FCCT-200x2.5	53.00	8	200	5	50	22	10	98.07	100	200
FCCT-150x3.2	46.00	6	150	5	35	26	12	117.68	100	250
FCCT-200x3.2	60.00	8	200	5	50	26	12	117.68	100	200
FCCT-250x3.2	105.00	10	250	5	65	26	12	117.68	100	170
FCCT-300x3.2	120.00	12	300	5	75	26	12	117.68	100	140
FCCT-150x3.6	64.00	6	150	5	35	44	18	176.52	100	250
FCCT-200x3.6	92.00	8	200	5	50	44	18	176.52	100	200
FCCT-250x3.6	118.00	10	250	5	65	44	18	176.52	100	170
FCCT-300x3.6	135.00	12	300	5	75	44	18	176.52	100	140
FCCT-200x4.8	125.00	8	200	5	50	50	23	225.55	100	150
FCCT-250x4.8	155.00	10	250	5	65	50	23	225.55	100	150
FCCT-300x4.8	200.00	12	300	5	75	50	23	225.55	100	120
FCCT-350x4.8	230.00	14	350	5	85	50	23	225.55	100	100
FCCT-368x4.8	250.00	15	368	5	100	50	23	225.55	100	100
FCCT-400x4.8	280.00	16	400	5	110	50	23	225.55	100	100
FCCT-450x4.8	320.00	18	450	5	130	50	23	225.55	100	90
FCCT-550x4.8	360.00	22	550	5	160	50	23	225.55	100	70
FCCT-200x7.6	250.00	8	200	6	50	75	35	343.23	100	80
FCCT-300x7.6	320.00	12	300	6	75	75	35	343.23	100	80
FCCT-380x7.6	460.00	15	380	6	102	75	35	343.23	100	70
FCCT-450x7.6	550.00	18	450	6	130	75	35	343.23	100	60
FCCT-500x7.9	800.00	20	500	6	150	75	35	343.23	100	35
FCCT-550x7.9	900.00	22	550	6	160	75	35	343.23	100	35
FCCT-650x9.0	1100.00	26	650	6	180	90	60	588.40	100	30
FCCT-750x9.0	1400.00	30	750	6	185	90	60	588.40	100	10
FCCT-920x9.0	1800.00	36	920	6	270	90	60	588.40	100	10
FCCT-1220x9.0	2700.00	48	1220	6	305	90	60	588.40	100	10
RELEASEABLE CABLE FASTENERS										
FCCT-150x3.6	100.00	6	150	2	35	44	18	176.52	100	250
FCCT-200x4.8	180.00	8	200	3	50	50	23	225.55	100	150
FCCT-250x4.8	250.00	10	250	3	65	50	23	225.55	100	150
FCCT-200x7.4	300.00	8	300	3	50	75	35	343.23	100	150
FCCT-200x3.8	300.00	8	200	3	50	44	18	176.52	100	250

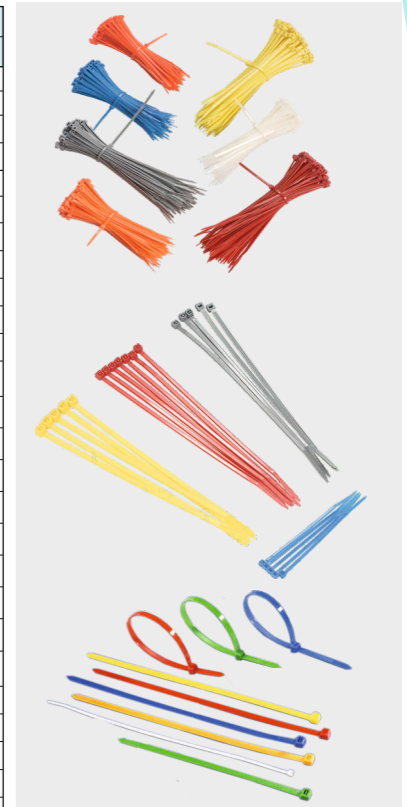

Mains Code Tie : FCMCT-01 Rs. 350 Per 100 Pcs.

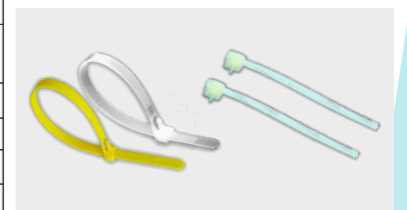



STAINLESS STEEL CABLE TIES (UN COATED)
Ball - Self Locking
Operating Temperature : - 80°C to 538°C
Tensile Strength : 45 Kg.

Sr No.	Product Code	Dimensions LxWxT (MM)	MRP Per 100 Pcs.
1.	FCSSUC-100x4.6	100x4.6x0.25	1700.00
2.	FCSSUC-150x4.6	150x4.6x0.25	1900.00
3.	FCSSUC-200x4.6	200x4.6x0.25	2200.00
4.	FCSSUC-250x4.6	250x4.6x0.25	2400.00
5.	FCSSUC-300x4.6	300x4.6x0.25	2500.00
6.	FCSSUC-360x4.6	360x4.6x0.25	2700.00
7.	FCSSUC-450x4.6	450x4.6x0.25	3100.00
8.	FCSSUC-520x4.6	520x4.6x0.25	3500.00
9.	FCSSUC-680x4.6	680x4.6x0.25	4900.00
10.	FCSSUC-840x4.6	840x4.6x0.25	5300.00
11.	FCSSUC-1000x4.6	1000x4.6x0.25	6100.00
12.	FCSSUC-1500x4.6	1500x4.6x0.25	10000.00

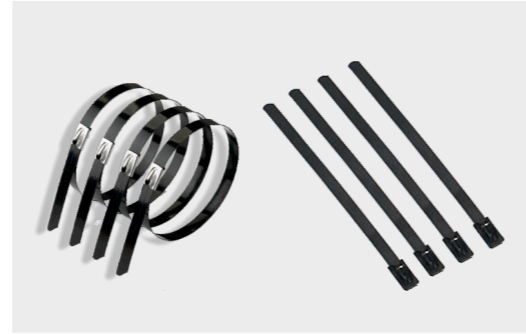

STAINLESS STEEL CABLE TIES (UN COATED)
Ball - Self Locking
Operating Temperature : - 80°C to 538°C
Tensile Strength : 105 Kg.

Sr No.	Product Code	Dimensions LxWxT (MM)	MRP Per 100 Pcs.
1.	FCSSUC-100x7.9	100x7.9x0.25	3200.00
2.	FCSSUC-150x7.9	150x7.9x0.25	3500.00
3.	FCSSUC-200x7.9	200x7.9x0.25	3500.00
4.	FCSSUC-250x7.9	250x7.9x0.25	3800.00
5.	FCSSUC-300x7.9	300x7.9x0.25	4000.00
6.	FCSSUC-360x7.9	360x7.9x0.25	4300.00
7.	FCSSUC-450x7.9	450x7.9x0.25	4900.00
8.	FCSSUC-520x7.9	520x7.9x0.25	5600.00
9.	FCSSUC-680x7.9	680x7.9x0.25	6500.00
10.	FCSSUC-840x7.9	840x7.9x0.25	7100.00
11.	FCSSUC-1000x7.9	1000x7.9x0.25	8400.00
12.	FCSSUC-1500x7.9	1000x7.9x0.25	13000.00

STAINLESS STEEL CABLE TIES (PVC COATED)
Ball - Self Locking
Operating Temperature :- 80°C to 150°C
Tensile Strength : 45 Kg.

Sr No.	Product Code	Dimensions LxWxT (MM)	MRP Per 100 Pcs.
1.	FCSSPC-100x4.6	100x4.6x0.25	2300.00
2.	FCSSPC-150x4.6	150x4.6x0.25	2800.00
3.	FCSSPC-200x4.6	200x4.6x0.25	3300.00
4.	FCSSPC-250x4.6	250x4.6x0.25	3700.00
5.	FCSSPC-300x4.6	300x4.6x0.25	3900.00
6.	FCSSPC-360x4.6	360x4.6x0.25	4300.00
7.	FCSSPC-450x4.6	450x4.6x0.25	5100.00
8.	FCSSPC-520x4.6	520x4.6x0.25	5900.00
9.	FCSSPC-680x4.6	680x4.6x0.25	7600.00
10.	FCSSPC-840x4.6	840x4.6x0.25	9900.00
11.	FCSSPC-1000x4.6	1000x4.6x0.25	11000.00
12.	FCSSPC-1500x4.6	1500x4.6x0.25	17500.00

STAINLESS STEEL CABLE TIES (PVC COATED)
Ball - Self Locking
Operating Temperature :- 80°C to 150°C
Tensile Strength : 105 Kg.

Sr No.	Product Code	Dimensions LxWxT (MM)	MRP Per 100 Pcs.
1.	FCSSPC-100x7.9	100x7.9x0.25	3700.00
2.	FCSSPC-150x7.9	150x7.9x0.25	4200.00
3.	FCSSPC-200x7.9	200x7.9x0.25	4800.00
4.	FCSSPC-250x7.9	250x7.9x0.25	5500.00
5.	FCSSPC-300x7.9	300x7.9x0.25	6100.00
6.	FCSSPC-360x7.9	360x7.9x0.25	6800.00
7.	FCSSPC-450x7.9	450x7.9x0.25	7500.00
8.	FCSSPC-520x7.9	520x7.9x0.25	8700.00
9.	FCSSPC-680x7.9	680x7.9x0.25	11300.00
10.	FCSSPC-840x7.9	840x7.9x0.25	14000.00
11.	FCSSPC-1000x7.9	1000x7.9x0.25	17000.00
12.	FCSSPC-1500x7.9	1500x7.9x0.25	25000.00

Plastic Dust Protection Cap.

Material :- Virgin LDPE

Color :- Red

Plastic Dust Caps are mainly used in Hydraulic and Pneumatic Industry.



Sr. No.	Size Male/Female				
	MM		BSP	UNF	NPT
1.	M8x1	M22x1.5x35	1/8	7/16	1/8
2.	M10x1	M24x1.5	1/4	1/2	1/4
3.	M10x1.5	M26x1.5	3/8	9/16	3/8
4.	M12x1	M30x1.5	1/2	3/4	1/2
5.	M12x1.5	M30x2	5/8	7/8	3/4
6.	M14x1.5	M35x1.5	3/4	11/16	1
7.	M16x1.5	M36x1.5	1	1 5/16	1 1/4
8.	M18x1.5	M36x2	1 1/4		1 1/2
9.	M20x1.5	M45x2	1 1/2		
10.	M22x1.5	M52x2	2		
11.			2 1/2		

Nylon Soft Blow Hammer

Material :- Toughened Nylon 6

Spare Tips available separately.

Product Code.	Hammer Size		Prices Per Nos.	
	mm	Inches	Hammer	Tips
FCSBH-01	25	1	441.00	33.00
FCSBH-02	32	1 1/4	500.00	40.00
FCSBH-03	38	1 1/2	604.00	57.00
FCSBH-04	45	1 3/4	741.00	82.00
FCSBH-05	50	2	957.00	127.00



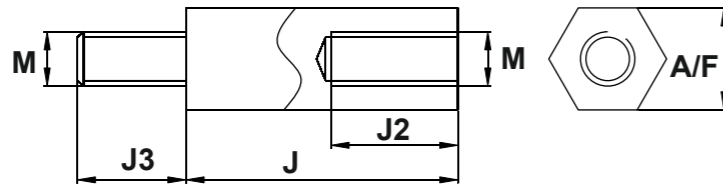

Nylon Molded Hexagonal Spacers

Sr.No.	Thread	Product code	List price	Thread	Product code	List price	Thread	Product code	List price	A/F	J	J2	J3
Female-Female			Female-Female			Female-Female							
1.	M4	FCM4HFF-025	28.00	M5	FCM5HFF-025	30.00	M6	FCM6HFF-025	32.00	20	25.0	10.5	
2.	M4	FCM4HFF-030	29.00	M5	FCM5HFF-030	32.00	M6	FCM6HFF-030	34.00	20	30.0	10.5	
3.	M4	FCM4HFF-035	31.00	M5	FCM5HFF-035	33.00	M6	FCM6HFF-035	36.00	20	35.0	10.5	
4.	M4	FCM4HFF-040	33.00	M5	FCM5HFF-040	34.00	M6	FCM6HFF-040	38.00	20	40.0	10.5	
5.	M4	FCM4HFF-045	34.00	M5	FCM5HFF-045	36.00	M6	FCM6HFF-045	40.00	20	45.0	10.5	
6.	M4	FCM4HFF-050	36.00	M5	FCM5HFF-050	38.00	M6	FCM6HFF-050	41.00	20	50.0	10.5	
Male-Female			Male-Female			Male-Female							
7.	M4	FCM4HMF-020	25.00	M5	FCM5HMF-020	27.00	M6	FCM6HMF-020	28.00	20	20.0	10.5	10.0
8.	M4	FCM4HMF-025	26.00	M5	FCM5HMF-025	28.00	M6	FCM6HMF-025	30.00	20	25.0	10.5	10.0
9.	M4	FCM4HMF-030	28.00	M5	FCM5HMF-030	30.00	M6	FCM6HMF-030	31.00	20	30.0	10.5	10.0
10.	M4	FCM4HMF-035	29.00	M5	FCM5HMF-035	32.00	M6	FCM6HMF-035	32.00	20	35.0	10.5	10.0
11.	M4	FCM4HMF-040	30.00	M5	FCM5HMF-040	34.00	M6	FCM6HMF-040	34.00	20	40.0	10.5	10.0
12.	M4	FCM4HMF-045	32.00	M5	FCM5HMF-045	36.00	M6	FCM6HMF-045	36.00	20	45.0	10.5	10.0
13.	M4	FCM4HMF-050	34.00	M5	FCM5HMF-050	40.00	M6	FCM6HMF-050	38.00	20	50.0	10.5	10.0
14.	M4	FCM4HMF-060	38.00	M5	FCM5HMF-060	40.00	M6	FCM6HMF-060	42.00	20	60.0	10.5	10.0
Male-Male			Male-Male			Male-Male							
15.	M4	FCM4HMM-020	25.00	M5	FCM5HMM-020	27.00	M6	FCM6HMM-020	28.00	20	20.0		10.0
16.	M4	FCM4HMM-025	26.00	M5	FCM5HMM-025	28.00	M6	FCM6HMM-025	30.00	20	25.0		10.0
17.	M4	FCM4HMM-030	28.00	M5	FCM5HMM-030	30.00	M6	FCM6HMM-030	31.00	20	30.0		10.0
18.	M4	FCM4HMM-035	29.00	M5	FCM5HMM-035	30.00	M6	FCM6HMM-035	32.00	20	35.0		10.0
19.	M4	FCM4HMM-040	30.00	M5	FCM5HMM-040	32.00	M6	FCM6HMM-040	34.00	20	40.0		10.0
20.	M4	FCM4HMM-045	32.00	M5	FCM5HMM-045	34.00	M6	FCM6HMM-045	36.00	20	45.0		10.0
21.	M4	FCM4HMM-050	34.00	M5	FCM5HMM-050	36.00	M6	FCM6HMM-050	38.00	20	50.0		10.0
22.	M4	FCM4HMM-060	38.00	M5	FCM5HMM-060	40.00	M6	FCM6HMM-060	42.00	20	60.0		10.0

Sr.No.	Thread	Product code	List price	Thread	Product code	List price	Thread	Product code	List price	A/F	J	J2	J3
Female-Female			Female-Female			Female-Female							
1.	M4	FCM4HFF-025	35.00	M5	FCM5HFF-025	38.00	M6	FCM6HFF-025	40.00	25	25.0	10.5	
2.	M4	FCM4HFF-030	37.00	M5	FCM5HFF-030	40.00	M6	FCM6HFF-030	44.00	25	30.0	10.5	
3.	M4	FCM4HFF-035	40.00	M5	FCM5HFF-035	43.00	M6	FCM6HFF-035	45.00	25	35.0	10.5	
4.	M4	FCM4HFF-040	43.00	M5	FCM5HFF-040	45.00	M6	FCM6HFF-040	48.00	25	40.0	10.5	
5.	M4	FCM4HFF-045	44.00	M5	FCM5HFF-045	48.00	M6	FCM6HFF-045	52.00	25	45.0	10.5	
6.	M4	FCM4HFF-050	48.00	M5	FCM5HFF-050	52.00	M6	FCM6HFF-050	56.00	25	50.0	10.5	
7.	M4	FCM4HFF-055	50.00	M5	FCM5HFF-055	55.00	M6	FCM6HFF-055	60.00	25	55.0	10.5	
Male-Female			Male-Female			Male-Female							
8.	M4	FCM4HMF-025	33.00	M5	FCM5HMF-025	35.00	M6	FCM6HMF-025	37.00	25	25.0	10.5	10.0
9.	M4	FCM4HMF-030	35.00	M5	FCM5HMF-030	38.00	M6	FCM6HMF-030	40.00	25	30.0	10.5	10.0
10.	M4	FCM4HMF-035	38.00	M5	FCM5HMF-035	42.00	M6	FCM6HMF-035	43.00	25	35.0	10.5	10.0
11.	M4	FCM4HMF-040	41.00	M5	FCM5HMF-040	44.00	M6	FCM6HMF-040	45.00	25	40.0	10.5	10.0
12.	M4	FCM4HMF-045	44.00	M5	FCM5HMF-045	48.00	M6	FCM6HMF-045	50.00	25	45.0	10.5	10.0
13.	M4	FCM4HMF-050	48.00	M5	FCM5HMF-050	50.00	M6	FCM6HMF-050	54.00	25	50.0	10.5	10.0
Male-Male			Male-Male			Male-Male							
14.	M4	FCM4HMM-025	33.00	M5	FCM5HMM-025	35.00	M6	FCM6HMM-025	37.00	25	25.0		10.0
15.	M4	FCM4HMM-030	35.00	M5	FCM5HMM-030	38.00	M6	FCM6HMM-030	40.00	25	30.0		10.0
16.	M4	FCM4HMM-035	38.00	M5	FCM5HMM-035	42.00	M6	FCM6HMM-035	43.00	25	35.0		10.0
17.	M4	FCM4HMM-040	41.00	M5	FCM5HMM-040	44.00	M6	FCM6HMM-040	45.00	25	40.0		10.0
18.	M4	FCM4HMM-045	44.00	M5	FCM5HMM-045	48.00	M6	FCM6HMM-045	50.00	25	45.0		10.0
19.	M4	FCM4HMM-050	48.00	M5	FCM5HMM-050	50.00	M6	FCM6HMM-050	54.00	25	50.0		10.0

Self Adhesive Tie mounts.



Sr.No.	Part No.	List Price	Size.	
			L	W
1.	FCTM -19	120.00	19	19
2.	FCTM - 25	190.00	25	25
3.	FCTM - 38	540.00	38	38
4.	FCTM - 50	850.00	50	50

Screw Mounting tie Support

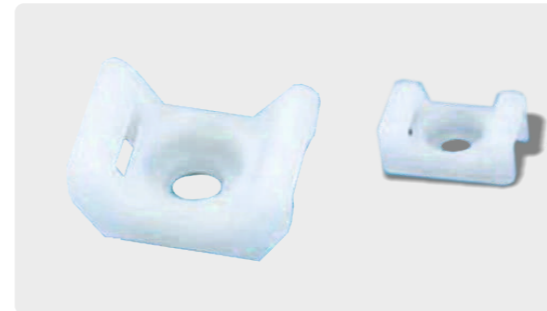

Sr.No.	Part No.	List Price	Max.Suitable Tie Width
1.	FCSMS-12	215.00	5 mm
2.	FCSMS-19	315.00	10 mm

Self Adhesive Wire Support

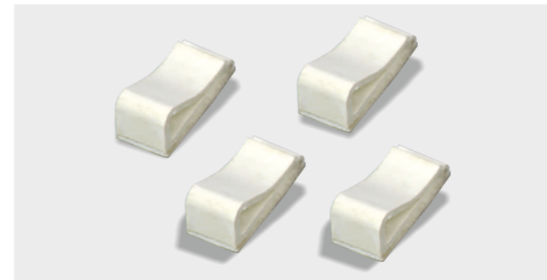

Sr.No.	Part No.	List price	Max.Suitable Wire Dia.
1.	FCSWS-01	320.00	8 mm

Spiral Wire Bind.

Material : LDPE
 Operating Temperature : -5°C to 80°C
 Spiral Wire Bind are Suitable for bunching of loose wire and Cable.

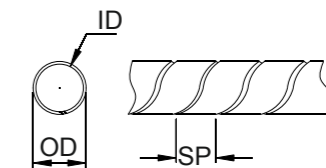

Product Code	List price per bundle	ID	OD	SP	Bundle Length Mtrs.
FCSB-04	216.00	4.0	6.0	7.0	50
FCSB-06	240.00	6.0	8.0	10.8	50
FCSB-09	240.00	7.5	10.0	11.4	25
FCSB-12	435.00	9.0	12.0	13.9	25
FCSB-15	635.00	12.0	15.0	15.0	25
FCSB-19	1100.00	15.0	19.0	18.3	25
FCSB-25	1400.00	20.0	24.0	19.6	25



Nylon Flexible Cable glands in Metric & PG Standards.

Technical Specification:

- Body : Polyamide 6
Sealing : EPDM
Temp : Static -30°C to 120°C
Dynamic -10°C to 80°C
Protection : I.P 65
Color : Grey, White & Black
Certification : ROHS.

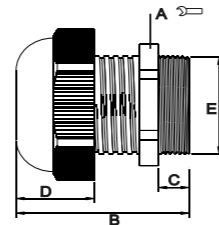

PG Threaded cable glands

Table with 11 columns: Sr. No., Threading type, Cable Range (in mm), Part No., List Price, A, B (Min. Max.), C, D, Ø E, Packing. Lists 11 different PG gland models.



CE Certified mm Threaded Nylon Flexible Cable Glands. Manufactured and tested as per BS EN 50262:1999 cable glands for electrical installation.

Table with 11 columns: Sr. No., Threading type, Cable Range (in mm), Part No., List Price, A, B (Min. Max.), C, D, Ø E, Packing. Lists 11 different metric threaded gland models.

- FC Cable glands are CE CERTIFIED and made of polyamide 6 ideally suited to guarantee optimum conditions for impact resistance and full insulation.
● Effective gripping is provided on tightening of caps, which ensure that complete strain relief is provided to your cables.
● Specially provided groove on internal part of the cap nut acts as a ratchet, which provides self locking and vibration resistant fixing on some glands.
● Easy mounting of cable glands are provided for introducing cables and conductors in to machines.
● Secure and fast connection in various industries ranging from machineries and equipment manufacturers, measuring and control electronics, automation, electrical and robotics.
● Protection class IP-65 liquid and dust tight connection provides total relief to your cable.

FLU-CON is a registered trademark of Flu-con Components Pvt Ltd.

All Information in this catalogue is based on latest product information available at the time of approval for printing. FLU-CON Components Pvt Ltd resolves the right to make changes any time without notice, without incurring any obligation. No part of this catalogue may be reproduced without written permission.

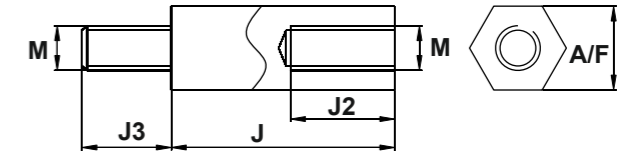

Nylon Molded Hexagonal Spacers

Table with 11 columns: Sr.No., Thread, Product code, List price, Thread, Product code, List price, A/F, J, M4-J2, M5-J2. Lists 18 different hexagonal spacer models.

Nylon Molded Hexagonal Spacers

Table with 11 columns: Sr.No., Thread, Product code, List price, Thread, Product code, List price, A/F, J, M4-J2, M5-J2, M4-J3, M5-J3. Lists 19 different hexagonal spacer models.

FLU-CON is a registered trademark of Flu-con Components Pvt Ltd.

All Information in this catalogue is based on latest product information available at the time of approval for printing. FLU-CON Components Pvt Ltd resolves the right to make changes any time without notice, without incurring any obligation. No part of this catalogue may be reproduced without written permission.



Nylon Molded Hexagonal Spacers

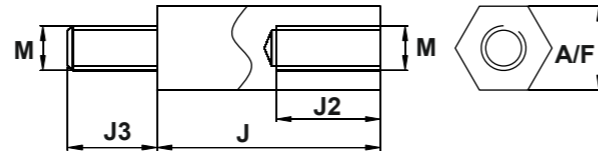

Nylon Molded Hexagonal Spacers

Sr.No.	Product code	List price	Thread	A/F	J	J2	J3
Male-Female							
1.	FCM3HMF-010	7.00	M3	6	10	4.0	8.0
2.	FCM3HMF-012	7.00	M3	6	12	4.0	8.0
3.	FCM3HMF-015	7.00	M3	6	15	8.5	8.0
4.	FCM3HMF-020	7.00	M3	6	20	8.5	8.0
5.	FCM3HMF-025	8.00	M3	6	25	8.5	8.0
6.	FCM3HMF-030	8.00	M3	6	30	8.5	8.0
Female-Female							
1.	FCM3HFF-010	7.00	M3	6	10	4.0	
2.	FCM3HFF-012	7.00	M3	6	12	4.0	
3.	FCM3HFF-015	7.00	M3	6	15	8.5	
4.	FCM3HFF-020	7.00	M3	6	20	8.5	
5.	FCM3HFF-025	8.00	M3	6	25	8.5	
6.	FCM3HFF-030	9.00	M3	6	30	8.5	

Sr.No.	M	Product code	List price	Thread	Product code	List price	A/F	J	J2	J3
Male-Female										
1.	M3	FCM3HMF-010	7.00	M4	FCM4HMF-010	7.00	8	10	5.0	8.0
2.	M3	FCM3HMF-012	7.00	M4	FCM4HMF-012	7.00	8	12	5.0	8.0
3.	M3	FCM3HMF-015	7.00	M4	FCM4HMF-015	8.00	8	15	8.5	8.0
4.	M3	FCM3HMF-020	8.00	M4	FCM4HMF-020	8.00	8	20	8.5	8.0
5.	M3	FCM3HMF-025	8.00	M4	FCM4HMF-025	9.00	8	25	8.5	8.0
6.	M3	FCM3HMF-030	8.00	M4	FCM4HMF-030	9.00	8	30	8.5	8.0
7.	M3	FCM3HMF-035	9.00	M4	FCM4HMF-035	9.00	8	35	8.5	8.0
8.	M3	FCM3HMF-040	9.00	M4	FCM4HMF-040	10.00	8	40	8.5	8.0
9.	M3	FCM3HMF-045	9.00	M4	FCM4HMF-045	10.00	8	45	8.5	8.0
10.	M3	FCM3HMF-050	10.00	M4	FCM4HMF-050	10.00	8	50	8.5	8.0
11.	M3	FCM3HMF-055	10.00	M4	FCM4HMF-055	11.00	8	55	8.5	8.0
12.	M3	FCM3HMF-060	11.00	M4	FCM4HMF-060	12.00	8	60	8.5	8.0
13.	M3	FCM3HMF-065	11.00	M4	FCM4HMF-065	12.00	8	65	8.5	8.0
14.	M3	FCM3HMF-070	12.00	M4	FCM4HMF-070	12.00	8	70	8.5	8.0
15.	M3	FCM3HMF-075	12.00	M4	FCM4HMF-075	13.00	8	75	8.5	8.0
16.	M3	FCM3HMF-080	13.00	M4	FCM4HMF-080	13.00	8	80	8.5	8.0
17.	M3	FCM3HMF-085	14.00	M4	FCM4HMF-085	14.00	8	85	8.5	8.0

Sr.No.	Thread	Product code	List price	Thread	Product code	List price	A/F	J	J2
Female-Female									
1.	M3	FCM3HFF-012	8.00	M4	FCM4HFF-012	9.00	8	12	5.0
2.	M3	FCM3HFF-015	8.00	M4	FCM4HFF-015	9.00	8	15	8.5
3.	M3	FCM3HFF-020	8.00	M4	FCM4HFF-020	9.00	8	20	8.5
4.	M3	FCM3HFF-025	9.00	M4	FCM4HFF-025	10.00	8	25	8.5
5.	M3	FCM3HFF-030	10.00	M4	FCM4HFF-030	10.00	8	30	8.5
6.	M3	FCM3HFF-035	10.00	M4	FCM4HFF-035	11.00	8	35	8.5
7.	M3	FCM3HFF-040	11.00	M4	FCM4HFF-040	11.00	8	40	8.5
8.	M3	FCM3HFF-045	11.00	M4	FCM4HFF-045	11.00	8	45	8.5
9.	M3	FCM3HFF-050	11.00	M4	FCM4HFF-050	12.00	8	50	8.5
10.	M3	FCM3HFF-055	12.00	M4	FCM4HFF-055	12.00	8	55	8.5
11.	M3	FCM3HFF-060	12.00	M4	FCM4HFF-060	12.00	8	60	8.5
12.	M3	FCM3HFF-065	12.00	M4	FCM4HFF-065	13.00	8	65	8.5
13.	M3	FCM3HFF-070	13.00	M4	FCM4HFF-070	13.00	8	70	8.5
14.	M3	FCM3HFF-075	13.00	M4	FCM4HFF-075	14.00	8	75	8.5
15.	M3	FCM3HFF-080	14.00	M4	FCM4HFF-080	15.00	8	80	8.5
16.	M3	FCM3HFF-085	15.00	M4	FCM4HFF-085	16.00	8	85	8.5

Spiral Cable Glands in METRIC & PG Threads.

Color : Grey/Black



Sr.No.	Part No.	List Price	A	B	A/F	Packing
1.	FC-SCG-7	28.50	47	7.50	15.00	25 Nos.
2.	FC-SCG-9	33.50	56	8.25	18.75	25 Nos.
3.	FC-SCG-11	36.00	67	8.25	21.50	25 Nos.
4.	FC-SCG-13.5	44.00	74	9.00	23.75	25 Nos.
5.	FC-SCG-16	51.50	87	10.00	26.75	25 Nos.
6.	FC-SCG-21	73.50	105	11.00	32.50	25 Nos.
7.	FC-SCG-M12x1.5	30.00	47	7.50	15.00	25 Nos.
8.	FC-SCG-M16x1.5	32.00	56	8.25	18.75	25 Nos.
9.	FC-SCG-M20x1.5	45.00	74	9.00	23.75	25 Nos.
10.	FC-SCG-M25x1.5	54.00	87	10.00	26.75	25 Nos.
11.	FC-SCG-M32x1.5	76.00	105	11.00	32.50	25 Nos.

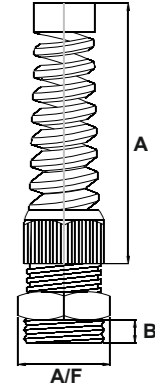

● FC-SCG Cable glands have all features of standard PG Thread Cable Glands with an added cable support to prevent damage and kinks in the cable.

Nylon Straight Cable Glands

Technical Specification:

Body : Polyamide 6
 Sealing Washer : PVC
 Temp : Static - 20°C to 80°C
 Dynamic : - 10°C to 60°C
 Protection : Open
 Color : Black only
 Item Contents : Body, Cap, Nut, PVC Washer.

Sr.No.	Part No.	List Price	Min. C	Max. C	D	Lock Nut E	Ø F	Packing
1.	FCST-16	12.50	35.0	33.0	11	5	14.0	25 Nos
2.	FCST-20	13.50	37.0	35.0	11	5	17.5	25 Nos
3.	FCST-25	17.00	37.5	35.0	11	5	24.0	25 Nos
4.	FCST-32	26.50	40.0	37.5	11	5	30.0	25 Nos

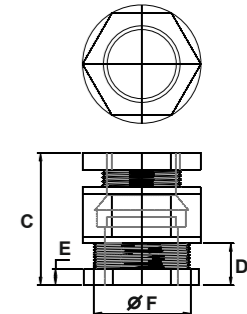

Flexible Conduit Pipe Gland Suitable for Flexible Conduit Pipes.

CP glands are available in mm threads.
 Specially designed teeth for effective gripping and sealing of conduit pipes.
 Conduit Pipe glands are ideally suited for use where a number of wires are to be passed through a single panel port or machine part.
 Available Black and Grey Colors.
 Material : ABS.



Sr.No.	Part No.	List Price	Pipe Size	Pipe Size ID	Pipe Size OD	C	Ø F	Packing
1.	FCCP-16	12.00	12	11	16	30	15.5	25 Nos
2.	FCCP-20	15.50	16	15	20	31	18.5	25 Nos
3.	FCCP-25	21.00	20	19	25	37	23.5	25 Nos
4.	FCCP-32	23.00	25	25	32	40	30.5	25 Nos
5.	FCCP-38	25.00	30	28	38	40	30.5	25 Nos
6.	FCCP-40	25.00	32	32	40	40	38.0	25 Nos
7.	FCCP-50	31.10	40	40	50	50	48.0	25 Nos

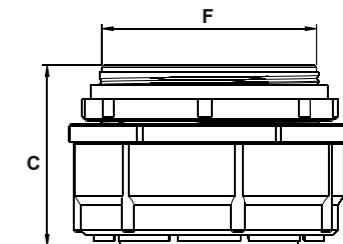



Polyamide Toughened conduit pipes.

Material :Toughened Polyamide 6
 IP RATING : IP 68 with ends properly sealed or in combination with suitable glands.
 Resistant : Most chemicals and alkalies, good weathering properties.
 UV stabilized conduits available upon request.
 Slitted conduit pipes available on MOQ basis.
 Tensile modules : 17300 Kg(f)cm2
 Flexural modules : 18400 Kg(f)cm2
 Tensile strength : 590 Kg/cm2
 Impact strength : 20 Kg/cm2
 Temperature range : -10°C to 90°C
 Color : Black (Other colors prices will be 15% additional)



Sr. No.	Part No.	Compatible PG size.	Compatible Metric Size	MRP Per Mtr.	Pipe size in mm		Bending radius	Packing in meters
					ID	OD		
1.	FCNCP-10 ID	PG-7	M12x1.5	59.00	9.6	13.0	20	50
2.	FCNCP-12 ID	PG-9	M16x1.5	67.00	11.8	15.8	30	50
3.	FCNCP-16 ID	PG-13.5	M20x1.5	76.00	16.5	21.2	40	50
4.	FCNCP-22 ID	PG-16	M25x1.5	96.00	21.7	28.5	42	50
5.	FCNCP-29 ID	PG-36	M40x1.5	146.00	29.0	34.5	55	50
6.	FCNCP-36 ID	PG-42	M50x1.5	206.00	36.0	42.5	62	25
7.	FCNCP-48 ID	PG-48	M63x1.5	265.00	48.0	54.5	72	25

Quick coupling flexible conduit gland / adaoptor suitable for conduit pipes.

Material : Polyamide 6 Color : Black
 IP Rating : IP 55



Sr.No.	Part No.	Assembly Threading	MRP Per pcs	Suitable FC conduit pipe part No.	Pipe Size ID	Pipe Size OD	Packing
1.	FCQCP-12	M12x1.5	31.00	FCNCP-10 ID	9.6	13.0	25 Nos.
2.	FCQCP-16	M16x1.5	34.00	FCNCP-12 ID	11.8	15.8	25 Nos.
3.	FCQCP-20	M20x1.5	40.00	FCNCP-16 ID	16.5	21.2	25 Nos.
4.	FCQCP-25	M25x1.5	47.00	FCNCP-22 ID	21.7	28.5	25 Nos.
5.	FCQCP-32	M32x1.5	86.00	FCNCP-29 ID	29.0	34.5	25 Nos.
6.	FCQCP-40	M40x1.5	106.00	FCNCP-29 ID	29.0	34.5	25 Nos.
7.	FCQCP-50	M50x1.5	130.00	FCNCP-36 ID	36.0	42.5	10 Nos.
8.	FCQCP-63	M63x1.5	177.00	FCNCP-48 ID	48.0	54.5	10 Nos.

Sr.No.	Part No.	Assembly Threading	MRP Per pcs	Suitable FC conduit pipe part No.	Pipe Size ID	Pipe Size OD	Bending Radius	Packing Nos
1.	QCFC - PG7/10	PG-7	31.00	FCNCP-10 ID	9.6	13	20	25
2.	QCFC - PG9/10	PG-9	33.00					
3.	QCFC - M12/10	M12x1.5	33.00					
4.	QCFC - M16/10	M16x1.5	33.00					
5.	QCFC - PG9/12	PG-9	34.00					
6.	QCFC - PG11/12	PG-11	38.00	FCNCP-12 ID	11.8	15.8	20	25
7.	QCFC - PG13.5/12	PG-13.5	40.00					
8.	QCFC - M16/12	M16x1.5	34.00					
9.	QCFC - 1/2"NPT/12	1/2 NPT	40.00					
10.	QCFC - PG19/12	PG-19	40.00					
11.	QCFC - PG11/16	PG-11	40.00	FCNCP-16 ID	16.5	21.2	40	25
12.	QCFC - PG13.5/16	PG-13.5	42.00					
13.	QCFC - PG16/16	PG-16	45.00					
14.	QCFC - PG19/16	PG-19	48.00					
15.	QCFC - M20/16	M20x1.5	40.00					
16.	QCFC - M25/16	M25x1.5	45.00	FCNCP-22ID	21.7	28.5	40	25
17.	QCFC - 1/2 NPT/16	1/2 NPT/16	47.00					
18.	QCFC -PG16/22	PG-16	50.00					
19.	QCFC - PG21/22	PG-21	52.00					
20.	QCFC - PG25/22	PG-25	50.00					
21.	QCFC - M25/22	M25x1.5	50.00	FCNCP-29 ID	29	34.5	55	25
22.	QCFC - PG19/22	PG-19	50.00					
23.	QCFC - PG29/29	PG-29	106.00					
24.	QCFC - M40/29	M40x1.5	106.00					
25.	QCFC - PG36/36	PG-36	130.00					
26.	QCFC - PG42/36	PG-42	140.00	FCNCP-36 ID	36	42.5	62	25
27.	QCFC - M50/36	M50x1.5	130.00					
28.	QCFC - PG48/48	PG-48	177.00					
29.	QCFC - M63/48	M63x1.5	265.00	FCNCP-48 ID	48	54.5	72	25

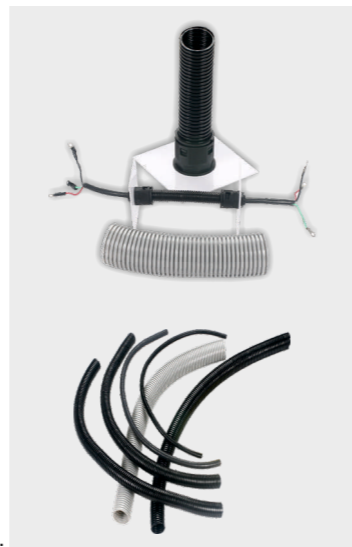

PBT Insulated Spacers.

Product Type : CYLINDRICAL MALE FEMALE WITH HEX CENTRE

Material : PBT 30% GF UL Certified V0
 Color : Grey RAL 7035 (Light Grey)
 Threading Inserts: Brass Tin plated or M.S.Tin Plated.

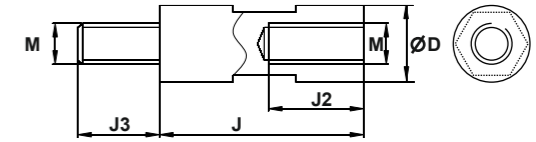

M3 SERIES IN CIRCULAR WITH HEX. CENTRE

Product Code.	List Price per pcs.	M	ØD	J	J2 Tol. +/-0.2	J3 Tol. +/-0.2
FCM3CH-015	16.50	3	6.8	15	7	6



M4 SERIES IN CIRCULAR WITH HEX. CENTRE

Product Code.	List price per pcs	M	ØD	J	J2 Tol. +/-0.2	J3 Tol. +/-0.2
FCM4CH-015	18.00	4	10	15	7	6
FCM4CH-020	22.50	4	10	20	7	6
FCM4CH-025	27.00	4	10	25	7	6
FCM4CH-123	59.00	6	14.5	123	7	6

PBT Insulated Spacers.

Product Type : HEX MODEL MALE FEMALE.
 Material : PBT 30% GF UL Certified V0
 Color : Grey RAL 7035 (Light Grey)
 Threading Inserts: Brass Tin plated or M.S.Tin Plated.

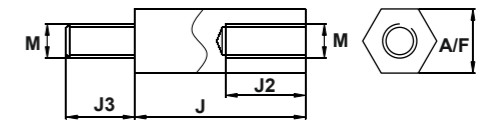

M6 SERIES WITH HEX. CENTRE

Product Code.	List price per pcs	M	A/F	J	J2 Tol. +/-0.2	J3 Tol. +/-0.2
FCM6H-020	24.00	6	13	20	8	7
FCM6H-025	26.00	6	13	25	8	7
FCM6H-030	28.00	6	13	30	8	7

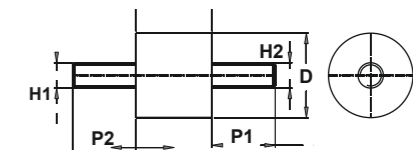
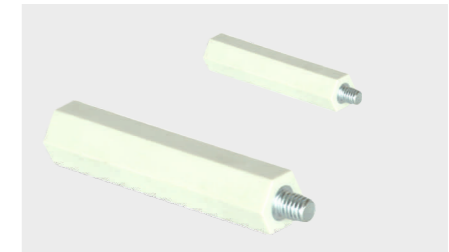

DMC Spacers Cylindrical Male-Male

Material : DMC ROHS & REACH COMPLIANCE.
 Color : White.

Product code	List price	L (mm)	Thread H1	Thread H2	Dia. D	P1 (mm)	P2 (mm)
FCCMM-03	20.00	10	M3	M3	10.	10	9.5





DMC Spacers Cylindrical Hex. Bottom Male-Male

Material : DMC ROHS & REACH COMPLIANCE
Colour : White.

Product Code	L (mm)	Dia. D	Thread H1	Thread H2	A/F	P1 (mm)	P2 (mm)
FCHMM-05	14	14	M5	M5	14	10	10

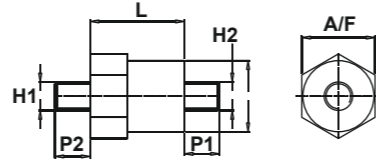

DMC Spacers Hexagonal Male-Female.

Material : DMC ROHS & REACH COMPLIANCE
Colour : White.

Product Code	L (mm)	A/F	Thread H1	Thread H2	Dia. D	P1 (mm)	P2 (mm)
FCHM-04	17	21	M4	M4	21mm	7	10
FCHM-06	17	21	M6	M6	21mm	7	10

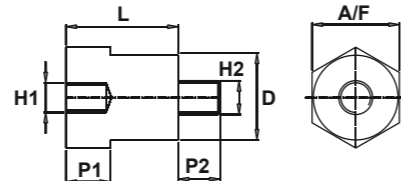

DMC Spacers Hexagonal Male-Female.

Material : DMC ROHS & REACH COMPLIANCE.
Colour : White.

Product Code	L (mm)	A/F	Thread H1	Thread H2	Dia. D	P1 (mm)	P2 (mm)
FCHF-04	17	14	M4	M4	14	10	7
FCHF-08	26	14	M8	M8	14	10	7

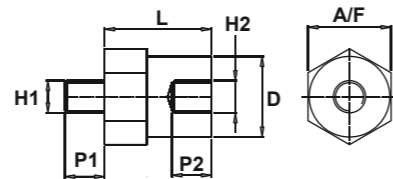

Blanking Plug in Metric & PG Threads.

Material : Polyamide.
Available in Black & Grey Color
Protection : IP - 54

IP 67 with rubber 'O' ring available at additional cost.

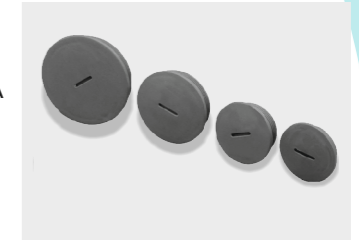
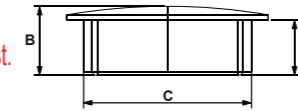

Sr.No.	Part No.	List price per 100 pcs.	A	B	∅C	Sr.No.	Part No.	List price per 100 pcs.	A	B	∅C
1.	FC-BP-7	579.00	6.0	8.0	12.4	11.	FCBP-M12x1.5	630.00	6.0	10.0	12.5
2.	FC-BP-9	643.00	6.0	9.0	15.2	12.	FCBP-M16x1.5	643.00	7.0	11.5	16.5
3.	FC-BP-11	643.00	9.5	9.0	18.3	13.	FCBP-M20x1.5	707.00	7.0	9.5	20.5
4.	FC-BP-13.5	707.00	9.5	9.5	20.0	14.	FCBP-M25x1.5	1119.00	11.0	15.5	25.5
5.	FC-BP-16	733.00	9.5	9.5	22.5	15.	FCBP-M32x1.5	2083.00	11.0	16.0	32.5
6.	FC-BP-21	771.00	11.0	11.0	28.5	16.	FCBP-M40x1.5	2379.00	13.0	18.0	41.0
7.	FC-BP-29	1119.00	12.0	12.0	36.7	17.	FCBP-M50x1.5	2777.00	13.0	18.5	51.0
8.	FC-BP-36	2083.00	15.0	15.0	47.0	18.	FCBP-M63x1.5	3472.00	15.0	19.0	65.0
9.	FC-BP-42	2379.00	16.0	16.0	50.0						
10.	FC-BP-48	2777.00	12.0	16.0	60.0						

LOCK NUTS in Metric & PG Threads.

Material : Polyamide 6.
Available in Black & Grey Colour
Compatible with FC Cable Glands & Blanking Plugs.

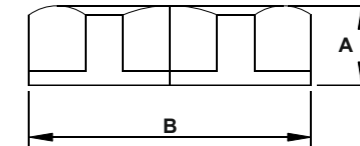

Sr.No.	Threading type	List price per 100 pcs.	Part No.	A	B	Sr.No.	Threading Type	List price per 100 pcs.	Part No.	A	B
1.	PG-7	230.00	FCLN-7	5.2	17.8	1.	M12x1.5	230.00	FCLN-M12x1.5	5.0	17.9
2.	PG-9	245.00	FCLN-9	5.2	24.5	2.	M16x1.5	245.00	FCLN-M16x1.5	5.1	24.3
3.	PG-11	260.00	FCLN-11	5.2	26.5	3.	M20x1.5	300.00	FCLN-M20x1.5	6.1	30.0
4.	PG-13.5	300.00	FCLN-13.5	6.1	29.5	4.	M25x1.5	350.00	FCLN-M25x1.5	6.2	33.6
5.	PG-16	350.00	FCLN-16	6.2	33.5	5.	M32x1.5	420.00	FCLN-M32x1.5	7.3	39.9
6.	PG-21	450.00	FCLN-21	7.0	39.0	6.	M40x1.5	860.00	FCLN-M40x1.5	8.0	48.0
7.	PG-29	635.00	FCLN-29	7.0	50.5	7.	M50x1.5	1300.00	FCLN-M50x1.5	8.0	58.0
8.	PG-36	950.00	FCLN-36	8.0	67.0	8.	M63x1.5	1800.00	FCLN-M63x1.5	9.5	78.0
9.	PG-42	1100.00	FCLN-42	8.0	66.0						
10.	PG-48	1500.00	FCLN-48	9.5	78.66						
11.	PG-63	1800.00	FCLN-63	9.5	81.60						

Rubber Grommets and closures

Material : Rubber EPDM.
Material : Plastic PVC HRC 60 - 65. (Soft)
Suitable for 2 mm, 2.5 mm & 3 mm Sheet.

CAT. No.	List price per 100 pcs.	Sheet Hole		Diameter
		Inches	mm	
FC-GB-01	220.00	3/8"	9.5	
FC-GB-02	290.00	1/2"	12.5	
FC-GB-03	310.00	5/8"	15.5	
FC-GB-04	350.00	3/4"	19.0	
FC-GB-05	370.00	7/8"	22.0	
FC-GB-06	400.00	1"	25.0	
FC-GB-07	560.00	1 1/4"	32.0	
FC-GB-08	680.00	1 1/2"	37.5	
FC-GB-09	900.00	1 3/4"	44.0	
FC-GB-10	1000.00	2"	50.0	
FC-GB-11	1120.00	2 1/4"	56.25	
FC-GB-12	1800.00	2 1/2"	62.5	
PVC GROMMETS- OPEN TYPE ONLY				
FC-GPB-04	230.00	3/4"	19.0	
FC-GPB-06	330.00	1"	25.0	





FLU CON Range of Inspection Windows are produced from quality raw materials conforming to international standard and specifications.
All windows are IP 66 rated and are in UV protective raw material of Polycarbonate.



Screw Type

Product Code:- FCMWG-04
List Price: 50.00 (PC)
Cut Out Size:- 92x92 mm
Viewing Area:- 90x90 mm
Material :- Polycarbonate
IP Protection Gasket :- EPDM

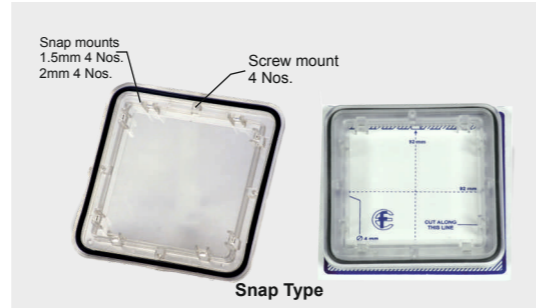

Snap Type

Product Code:- FCUWG-96x96
List Price : 76.00
Cut Out Size:- 92x92 mm
Viewing Area:- 90x90 mm
Material :- Polycarbonate
IP Protection Gasket :- EPDM
IP Protection Class:- IP 66
Provision for Screw fitting is also provided
Suitable for 1.5 and 2 mm Sheet.



Product Code:- FCHWG-200x200
List price: 517.00
Cut Out Size:- 157x157 mm
Viewing Area:- 150x150 mm
Material :- Polycarbonate
IP Protection Gasket :- EPDM
IP Protection Class:- IP 66



Screw Type

Product Code:- FCMWG-01
List Price: 77.00
Cut Out Size:- 90x130 mm
Viewing Area:- 86x126 mm
Material :- Polycarbonate
IP Protection Gasket :- EPDM



Screw Type

Product Code:- FCMWG-02
List Price: 103.00
Cut Out Size:- 120x160mm
Viewing Area:- 116x156 mm
Material :- Polycarbonate
IP Protection Gasket :- EPDM



Screw Type

Product Code:- FCMWG-03
List Price: 309.00
Cut Out Size:- 206x206 mm
Viewing Area:- 200x200 mm
Material :- Polycarbonate
IP Protection Gasket :- EPDM

Insulated Comb Bus Bar.

Rating : 100 Amps.
Material :- Conductor Cu. Insulation-PVC (ROHS)
Colour :- Light Grey
Sizes Available: Single Pole, 2 Pole, 3 Pole, 4 Pole. Pin & Fork Type.

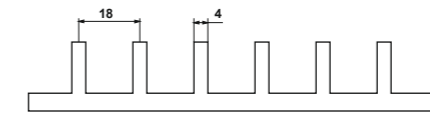
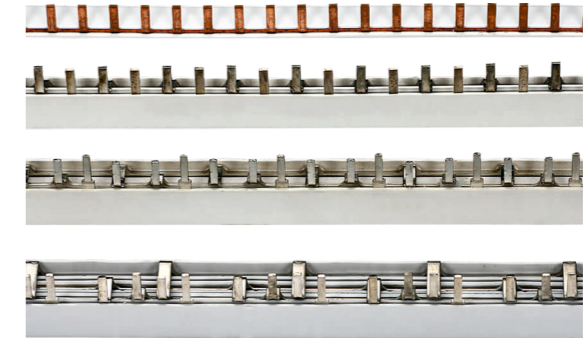
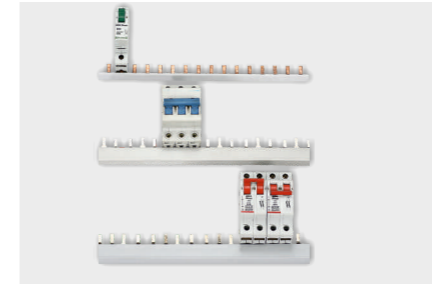

Pin Type.

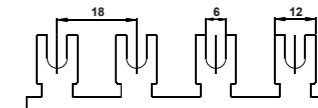
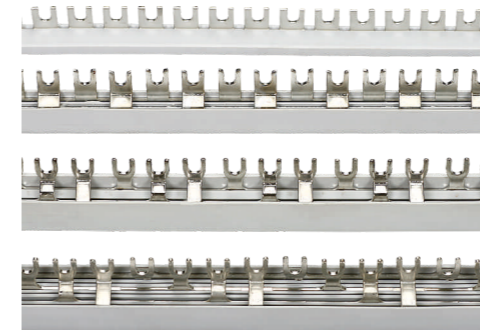

Fork Type.

Sr.No	Product Code	Length	Pin Type	List Price	
				Fork Type	End Caps(100pcs)
1.	FCICB-01	1 Mtr.	550.00	580.00	360.00
2.	FCICB-02	1 Mtr.	1020.00	1020.00	400.00
3.	FCICB-03	1 Mtr.	1300.00	1300.00	470.00
4.	FCICB-04	1 Mtr.	1900.00	1900.00	550.00





MCB Blanker Suitable for Blank Cut out in Control Panel and DB Box.

Product Type : single Module, 4 Module, 5 Module, 12 Module.
Material : ABS
Colour : Grey RAL - 7035.

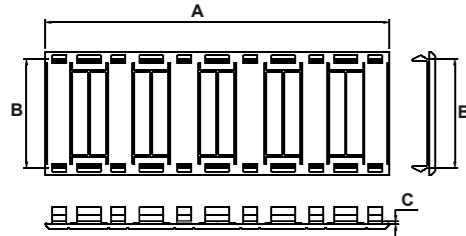

Product Code.	A	B	Sheet Size C	Cut out Size
FC5WB-146	146mm	45.5mm	1.5 to 2 mm	46x142mm
FC5WB-144	146mm	43.5mm	1.5 to 2 mm	44x142mm
FC4B-246	73mm	45.5mm	1.5 to 2 mm	46x68mm
FC12WB-246	216mm	45.5mm	1.5 to 2 mm	46x210mm

MCB Blanker Suitable for Blank Cut out in Control Panel and DB Box.

Product Type : single Module,
Material : ABS
Colour : Grey RAL- 7035.

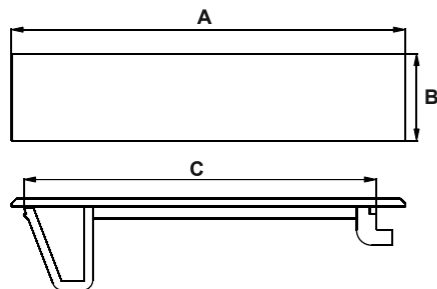

Product Code.	A	B	C	Sheet Size	Cut out Size
FCIWB-1850	54 mm	18 mm	50 mm	1.5 to 2 mm	50x17mm
FCIWB-1360	65 mm	13mm	60 mm	1.5 to 2 mm	60x12mm
FCIWB-2560	65 mm	25mm	60 mm	1.5 to 2 mm	60x24mm

FC5WB-146 } List Price: 25.00
FC5WB-144 }

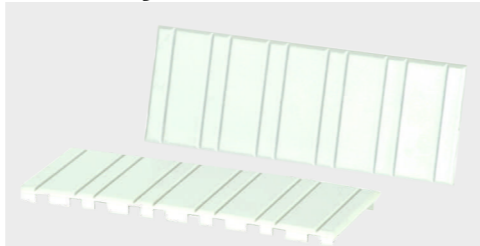

FC4B-246
List Price: 18.00



FC12WB-246
List Price: 40.00



FCIWB-1850 } List Price: 14.00
FCIWB-1360 }
FCIWB-2560 }



Air Breathers For Control panel cabinets, Industrial Machines and Equipments.

Material : Polypropylene
Colour : Grey, RAL- 7035
Temperature : 40°C to 80°C

Air Breather . Part No.FCAV-01B
List Price: 45.00

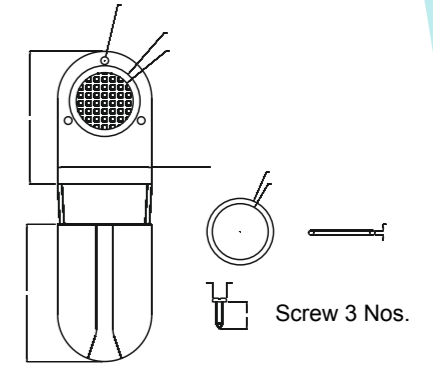

Material : Polyamide
Colour : Grey, RAL- 7035 /Black
Temperature : 45°C to 90°C

Air Breather . Part No.FCAV-03B
List Price: 45.00

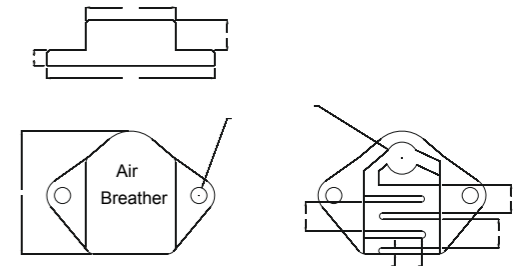

Size : 96x96 (Snap type)
Material : ABS
Color : Grey RAL 7035
Snap Fit provided for additional screw fitting.

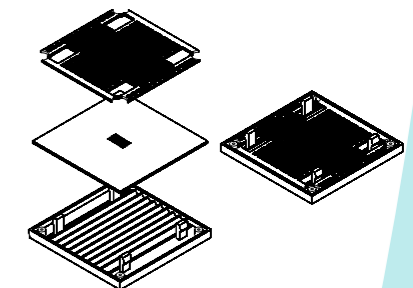

Product Code:- FCPFG-01
List Price: 50.00





Air Vent Surface Mounted with Screw Fitting.

Product Description : Air Ventilators with washable filters compatible with control panel exhaust fans.
Material : ABS
Color : Grey,RAL- 7035
Seal gasket : Sponge EVA.
Certification: ROHS.

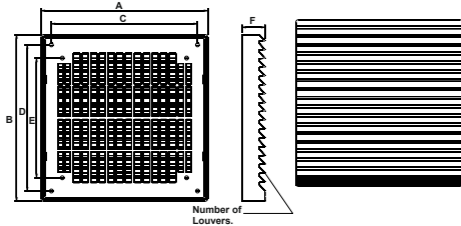

Product Code.	List Price	Sizes	A	B	C	D	E	F	Number of Louvers	Fan Compatibility	Packing
FCAV-04	65.00	90x90	90	90	71	71	N/A	17	9	3 Inches	100 Nos.
FCAV-01	65.00	130x130	130	130	105	105	96	22	14	4 Inches	100 Nos
FCAV-02	110.00	184x184	184	184	155	155	N/A	24	15	6 Inches	100 Nos
FCAV-03	300.00	238x238	238	238	185	185	213x213	35	19	8 Inches	50 Nos

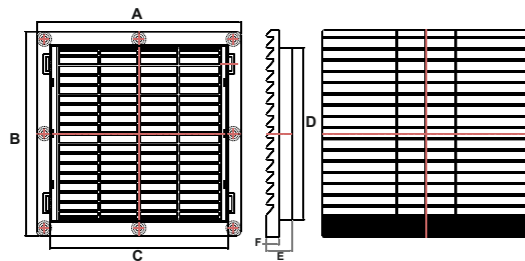

Air Vent Flush Mounted with snap fit

Product Description : Air Ventilators with washable filters.
Material : ABS
Color : Grey, RAL-7035
Seal gasket : Sponge EVA.
Certification: ROHS.

Product Code.	List Price	Sizes	A	B	E	F	Number of Louvers	Cut out Size		Packing
								C	D	
FCAV-01S	75.00	147x147	147	147	23.5	14.5	15	122.5	122.5	100 Nos
FCAV-02S	260.00	203x203	203	203	31	19	16	176	176	50 Nos
FCAV-03S	400.00	255x255	255	255	31	19	19	223	223	50 Nos
FCAV-04S	600.00	325x325	325	325	32	19	25	292	292	25 Nos



32 Amps. DIN Rail Mounted Connector.
Product Code:- FCDCN-01
List Price: 65.00

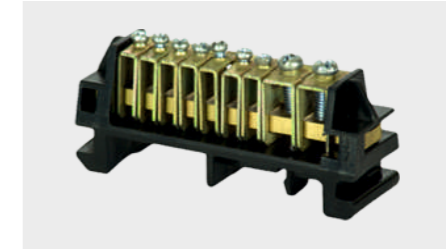

Connector 7x2 mm
Product Code:- FCCN-07
Material :- Housing Polyamide.
Terminal Bar Brass.
Connector M.S.
List Price: 221.00

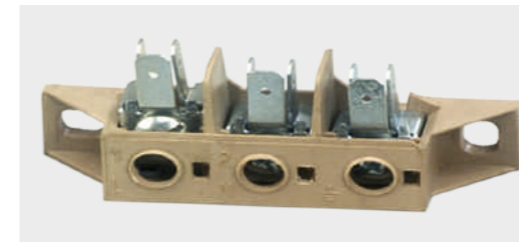

Mains Power Connector. 40Amps. 450V
Product Code:- FCMPC-01
List Price: 192.00



Product Code: FCIPC-01
List Price: 163.00
Insulation piercing connector for insulated ABC cable.

Material : Conductor Cu. Body: Polyamide 66.
Color : Black
Main Line : 25-95, Branch line - 2.5 - 25
Maximum current : 160 Amps.
Single shear Bolt.

conector

Terminal Strip
15 Amps 12 way terminal strip.
Rating- 380 volts rated current.
Plastic insulation- LD.
Connectors - Extruded brass tin plated.
Product code:FCISC02.
List Price: 100.00



FLU - CON Make Terminal Bases Suitable For Fixing of Neutral Links and Terminal Connectors.



Terminal Base
Product Code:- FCEB-01
 Material :- Backalite
List Price: 40.00



Single Way Base
Product Code:- FCEB-02
 Current Rating :- 32 Amps.
 Material :- Base-Backalite.
 Terminal-M.S zinc plated.
List Price: 104.00



Three Way Base
Product Code:- FCEB-03
 Current Rating :- 100Amps.
 Material :- Base-Backalite.
 Terminal-Copper.
List Price: 163.00

Equipotential Earth Bonding Bar
14 Way- 63 Amps.
Product Code:- FCEBB01



List price:
 With base : 515.00
 Without base : 470.00

Neutral Link & Neutral Break.

Product Code: FCNL/B-001
 Material : Housing Base - Polyamide 30% GF
 Conductor Strips - EC Grade copper Nickel Plated.
 Nut Bolts - M.S.Yellow passivation

Product Code	Item Description	Cu.Conductor Size. Thick.x Width	List Price	Std. Packing
FCNL -01	60 Amps Neutral Link	3x20 mm	124.00	100 Nos.
FCNL -02	100 Amps Neutral Link	5x20 mm	156.00	100 Nos.
FCNLB-03	100 Amps Neutral Link Break	3x20 mm	251.00	100 Nos.
FCNLB -04	150 Amps Neutral Link Break	5x20 mm	383.00	100 Nos.
FCNLB -05	200 Amps Neutral Link Break	5x25.4 mm	530.00	100 Nos.
FCNLB -06	250 Amps Neutral Link Break	6.3x25.4mm	577.00	100 Nos.



Document Holder.

Material :- ABS
 Colour:- Grey RAL 7035
 Fitting :- Provided With self adhesive foam tape

A5 SIZE.

L = 190
 W= 20
 H = 175

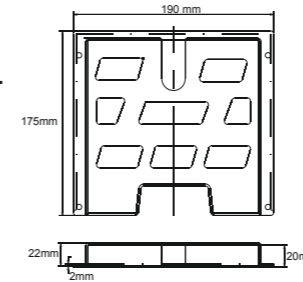

Product Code:- FCDOC-01

List Price: 70.00

A4 SIZE.

L = 276
 W= 38.5
 H = 232

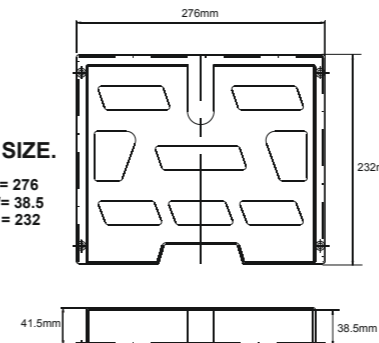

Product Code:- FCDOC-02

List Price: 135.00

A4 SIZE.

L = 282
 W= 17.5
 H = 272

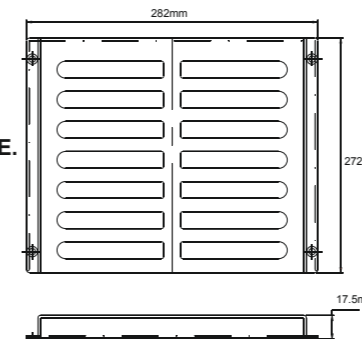

Product Code:- FCDOC-03

List Price: 95.00



Control Panel Door Knobs with Metal Lever suitable height 20,25,40,50 mm.
Material: Polyamide.

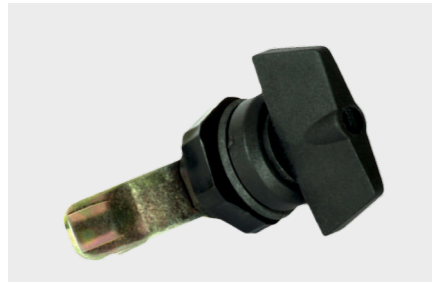

Product Code: FC-DK-01
List Price: 32.00

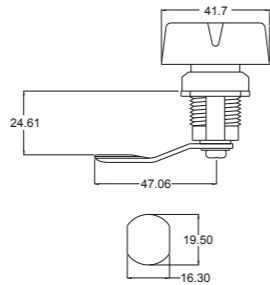

Product Code: FC-DK-02
List Price : 36.00

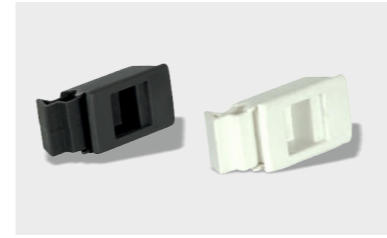

Product Code: FC SL-01
List price: 21.00
Snap Latch
Material: Polyamide.
Color : Black/Grey.

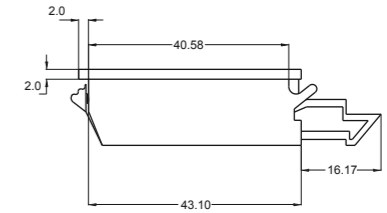
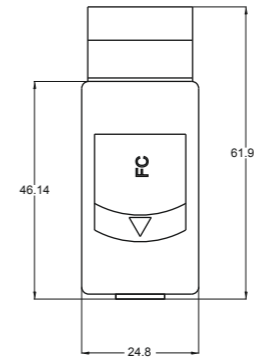

Product Code: FC-DK-03PL
List Price : 33.00

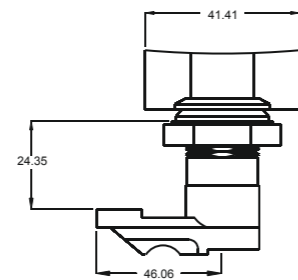

Product Code: FC-DK-04ML
List Price : 47.00



Product Code: FC MK-01 : Minus
FC SK-01 : Square
FCK-01 : Triangular
List Price : 12.00
Material: Polyamide.
Colour : Black/Grey.

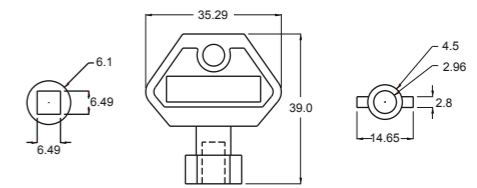
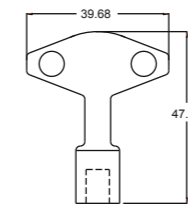

Product Code: FC-DK-05PL
List Price : 39.00

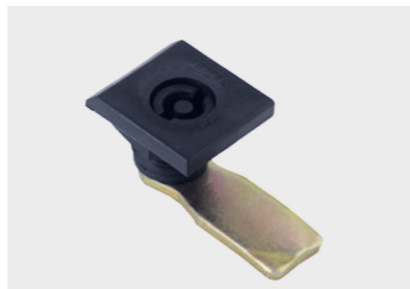
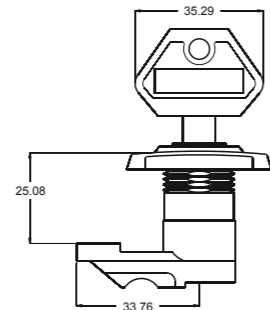

Product Code: FC-DK-06ML
List Price : 53.00



Product Code: FCHI-03
List price : 64.0
50mm Flat Hinge with
Mounting Screw.
Material: Polyamide.
Color : Black.

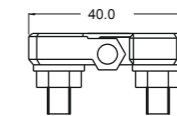
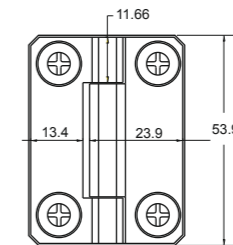

Product Code: FC-DK-07PL
List Price : 41.00

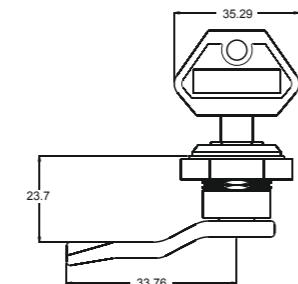

Product Code: FC-DK-08ML
List Price : 50.00



Product Code: FCHI-01
List Price: 19.00
180 Hinge for 2mm Sheet.
Material: Polyamide Body, Delrin Pin
Color : Black

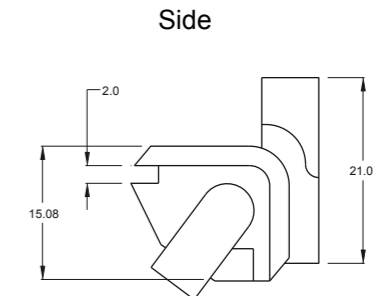
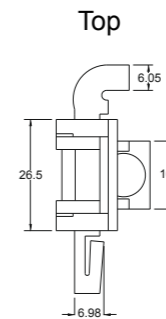



Product Code: FC-DLH-01
List price: 12.00
Door Label Holder
Material: Polycarbonate.
Color : Transparent

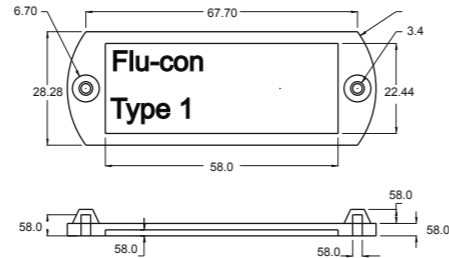

Product Code: FC-DLH-02
List Price : 12.00
Door Label Holder
Material: Polycarbonate.
Color : Transparent

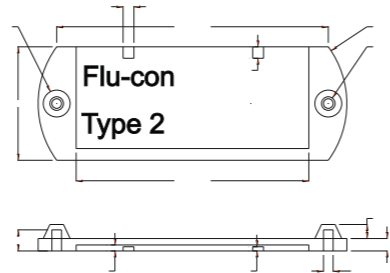

DC Tape Clip
For bare & Coated copper tape
Material :- Polyamide
Product Code:- FCDTC-01- 25x3 mm
FCDTC-02 - 30x6 mm
FCDTC-03 - 25X2.5 mm
List Price: 24.00

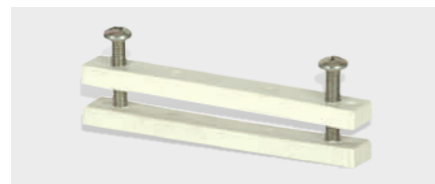
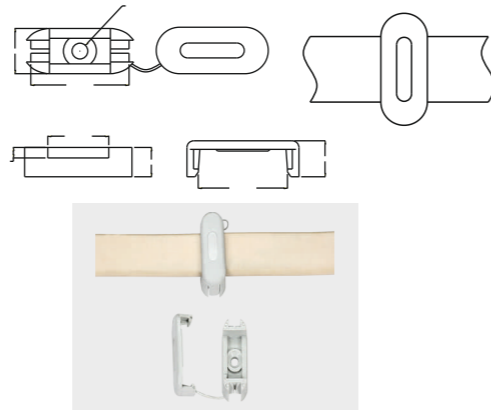

Current Transformer Cable Clamp
Product Code
FCCTH-01 List price: 29.50
FCCTH-02 List price: 35.50
Size:- 82 /115 mm
Material :- Polyamide.

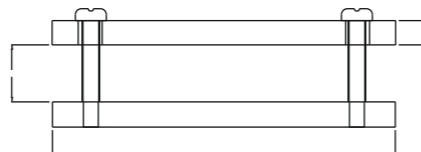

Line Tap

Material : Housing Base - PC/Polyamide.
 Cover- Polycarbonate.
 Brass Parts Drop Forged Zinc plated.
 Connector screws: - Brass Zinc plated.

Product Code	Item Description	Current Rating	List Price	Std. Packing
FCLT-01	95 Sq.mmx2way	150 Amps.	400.00	25 Nos.
FCLT-02	95 Sq.mmx4way	150 Amps.	571.00	25 Nos.
FCLT-03	150 Sq.mmx2way	250 Amps.	671.00	25 Nos.
FCLT-04	150 Sq.mmx4way	250 Amps.	1553.00	25 Nos.
FCLT-05	240 Sq.mmx2way	600 Amps.	2206.00	25 Nos.
FCLT-06	240 Sq.mmx4way	600 Amps.	2912.00	25 Nos.

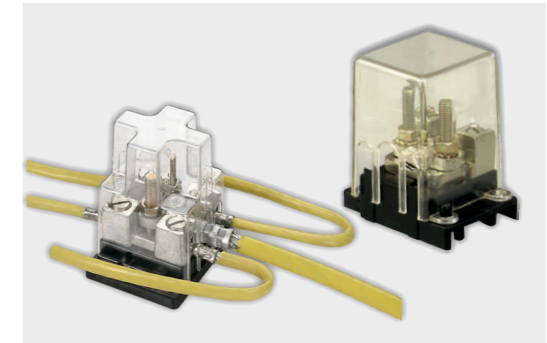

Line Tap

Product Code: FCLT-07
 Material : Housing Base - PC/Polyamide.
 Cover- Polycarbonate.
 Brass Parts Drop Forged Zinc plated..
 Screws :- Connector Screws Brass Zinc plated.
 Current Rating:- 150 Amps.



Branching Terminal.

Material : Housing Base: - ABS, Cover-Polycarbonate.
 Connector Block: - Brass Grade CZ121Pb4-Cu (56.5%-58.5%),
 Pb(3.5%-4.5%)
 Connector Plating:- Zinc Plated.
 Connection:- 2 incoming and 3 out going per connector
 Screws: - M.S.Yellow passivation

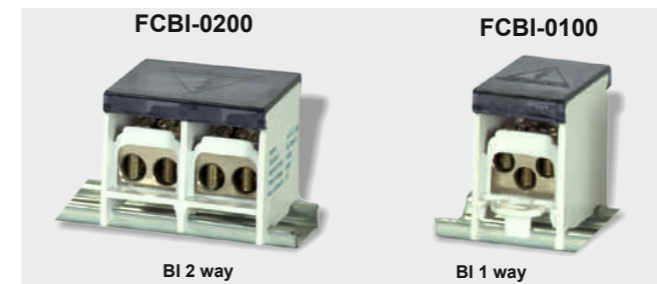

List Price: 359.00

List Price: 221.00

Also available bare connectors with single screw fitting on the bottom.



Extruded Terminal Bar. (Without base)

Material : Brass CZ.

Screws: - M.S.Yellow passivation

Terminal Bar are suitable for use with FLU-CON make bases in Polyamide, Bakelite & DMC.



15 Amps Terminal Bar

Product Code	Description	Number of Holes	Length (mm)	Weight per pcs (Gms)	List Price
FCTB-15-01	15 Amp x 4 way	5	50	22.63	66.00
FCTB-15-02	15 Amp x 6 way	7	64	28.48	81.00
FCTB-15-03	15 Amp x 8 way	9	78	34.33	98.00
FCTB-15-04	15 Amp x10 way	11	92	40.18	115.00
FCTB-15-05	15 Amp x 12 way	13	106	46.03	132.00
FCTB-15-06	15 Amp x 14 way	15	120	51.88	151.00
FCTB-15-07	15 Amp x 16 way	17	134	57.73	167.00
FCTB-15-08	15 Amp x 18 way	19	148	63.58	187.00
FCTB-15-09	15 Amp x 20 way	21	162	69.43	203.00
FCTB-15-10	15 Amp x 22 way	23	176	75.28	219.00
FCTB-15-11	15 Amp x 24 way	25	190	81.13	233.00
FCTB-15-12	15 Amp x 26 way	27	204	86.98	249.00
FCTB-15-13	15 Amp x 28 way	29	218	92.83	273.00
FCTB-15-14	15 Amp x 30 way	31	232	98.67	288.00
FCTB-15-15	15 Amp x 32 way	33	246	104.52	320.00
FCTB-15-16	15 Amp x 34 way	35	260	110.37	334.00
FCTB-15-17	15 Amp x 36 way	37	274	116.22	357.00

30 Amps Terminal Bar

Product Code	Description	Number of Holes	Length (mm)	Weight per pcs (Gms)	List Price
FCTB-30-01	30 Amp x 4 way	5	55	28.45	81.00
FCTB-30-02	30 Amp x 6 way	7	70	35.70	103.00
FCTB-30-03	30 Amp x 8 way	9	85	42.94	111.00
FCTB-30-04	30 Amp x10 way	11	100	50.18	147.00
FCTB-30-05	30 Amp x 12 way	13	115	57.42	167.00
FCTB-30-06	30 Amp x 14 way	15	130	64.67	190.00
FCTB-30-07	30 Amp x 16 way	17	145	71.91	210.00
FCTB-30-08	30 Amp x 18 way	19	160	79.15	232.00
FCTB-30-09	30 Amp x 20 way	21	175	86.39	252.00
FCTB-30-10	30 Amp x 22 way	23	190	93.64	274.00
FCTB-30-11	30 Amp x 24 way	25	205	100.88	297.00
FCTB-30-12	30 Amp x 26 way	27	220	108.12	318.00
FCTB-30-13	30 Amp x 28 way	29	235	115.36	338.00
FCTB-30-14	30 Amp x 30 way	31	250	122.61	360.00
FCTB-30-15	30 Amp x 32 way	33	265	129.85	381.00
FCTB-30-16	30 Amp x 34 way	35	280	137.09	404.00
FCTB-30-17	30 Amp x 36 way	37	295	144.33	416.00

60 Amps Terminal bar

Product Code	Description	Number of Holes	Length (mm)	Weight per pcs (Gms)	List Price
FCTB-60-01	60 Amp x 4 way	5	63	78.73	214.00
FCTB-60-02	60 Amp x 6 way	7	83	102.48	278.00
FCTB-60-03	60 Amp x 8 way	9	103	126.23	343.00
FCTB-60-04	60 Amp x10 way	11	123	149.98	406.00
FCTB-60-05	60 Amp x 12 way	13	143	173.73	473.00
FCTB-60-06	60 Amp x 14 way	15	163	197.48	536.00
FCTB-60-07	60 Amp x 16 way	17	183	221.23	600.00
FCTB-60-08	60 Amp x 18 way	19	203	244.98	663.00
FCTB-60-09	60 Amp x 20 way	21	223	268.83	728.00
FCTB-60-10	60 Amp x 22 way	23	243	292.48	793.00
FCTB-60-11	60 Amp x 24 way	25	263	316.23	856.00
FCTB-60-12	60 Amp x 26 way	27	283	339.98	920.00
FCTB-60-13	60 Amp x 28 way	29	303	363.73	986.00
FCTB-60-14	60 Amp x 30 way	31	323	387.48	1050.00
FCTB-60-15	60 Amp x 32 way	33	343	411.23	1113.00
FCTB-60-16	60 Amp x 34 way	35	363	434.98	1177.00
FCTB-60-17	60 Amp x 36 way	37	383	458.72	1243.00

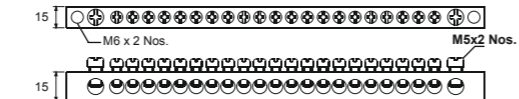
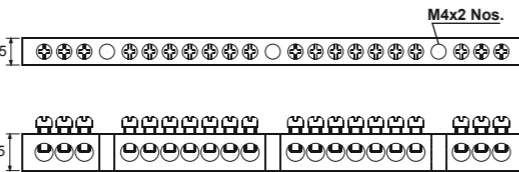
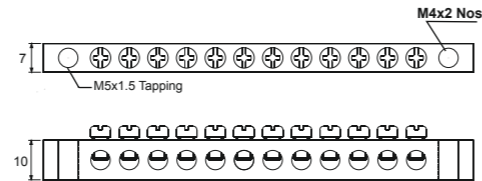

Also Available in meter Length and as per Customer Drawing or Specification.

FLU - CON Make Terminal Bases Suitable For Fixing of Neutral Links and Terminal Connectors.

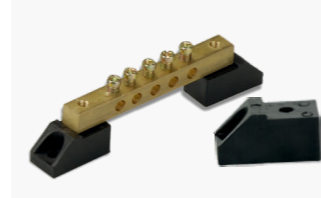
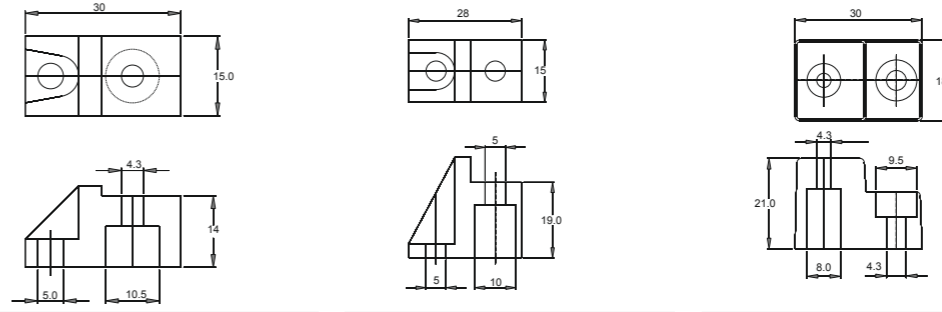

Terminal Base- Height 14mm
Product Code:- FCNLBP-01
Material :- Polyamide
List Price: 9.50

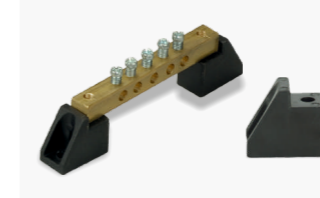

Terminal Base - Height-19mm
Product Code
FCNLBD-02-DMC
FCNLBP-02-Polyamide
FCNLBB-02-Bakelite
Material :- DMC/Backalite/Polyamide.
List Price:9.50

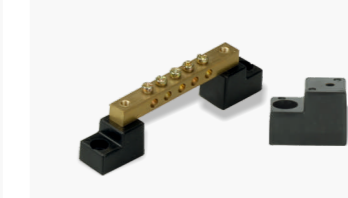

Terminal Base - Height- 21mm
Product Code
FCNLBD-03-DMC
FCNLBB-03-Bakelite
Material :- DMC/Backalite
List Price:10.50

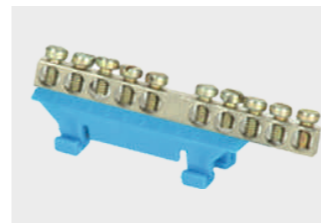

Din Rail Mounted Terminal Base
Product Code:- FCNLB-04
Material :- PP FR
List Price: 9.50



Din Rail Mounted Terminal Base
Product Code:- FCNLB-05
Material :- PP FR
List Price: 9.50



C- Channel Base
Product Code:- FCNLB-06
Material :- ABS
List Price: 9.50

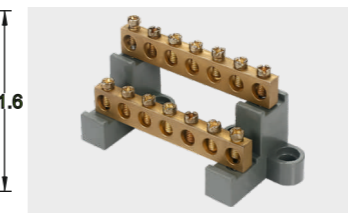
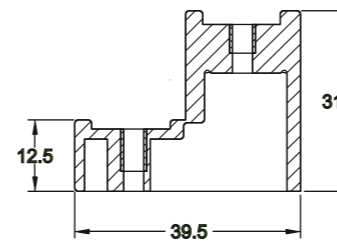

Terminal Base
Product Code: FCNLB-07 - STEP
Material: Polyamide
Inserts- Brass-M5
List Price: 100.00

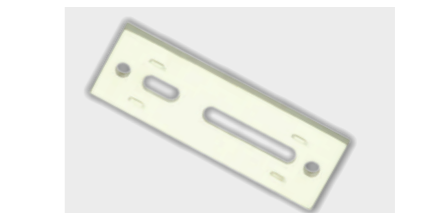

Terminal Base
Product Code
FCNLBN-04 -LW(80x15mm)
FCNLBN-05 -LW(25 x 15mm)
Suitable for 15 mm Width Open
Length Terminal
Material :- Polyamide
List Price: 9.50



FLU-CON is a registered trademark of Flu-con Components Pvt Ltd.

All Information in this catalogue is based on latest product information available at the time of approval for printing. FLU-CON Components Pvt Ltd resolves the right to make changes any time without notice, without incurring any obligation. No part of this catalogue may be reproduced without written permission.



FLU-CON is a registered trademark of Flu-con Components Pvt Ltd.

All Information in this catalogue is based on latest product information available at the time of approval for printing. FLU-CON Components Pvt Ltd resolves the right to make changes any time without notice, without incurring any obligation. No part of this catalogue may be reproduced without written permission.