



IMPORTED ARCHITECTURAL
HARDWARE ACCESSORIES
WITH STYLE & ELEGANCE
2014-2015



creation with heart , art makes difference
Always Be Positive

QUALITY
COMMITMENT
RELIABILITY



Hemdeep Enterprise - Mumbai
E-mail:- hemanshujj@hotmail.com
website:-www.cpyc2.com



Hemdeep Enterprise

MUMBAI

has specialized in the production of hardware decoration for tens of years, owning great strength and advanced technology, "CPY" brand decoration hardware products are highly favored with exquisite craftwork, excellent shape and nice design. and are well sold in every big city all over INDIA. Abiding by the operation tenet Dealing with honesty , Persuading with quality, Credit first, Customer foremost, it seeks more excellent quality. and constantly develops new products. Sincerely welcome vast merchants to us visits, business talks or ordering by the sample and drawing.

We welcome home and Indian clients to create future with us !

Company Introduction

2014-2015

INDEX



Shower Hinge
11



Patch Fitting
07



Hydraulic Patch
05



Floor Hinge/Door Closer
01 03



Glass Door Lock
15



Glass Stud
57-59



Glass Door Handle
19



Curtain Brackets
49

INDEX



Shelf Bracket Series
54



Decorative Handle
24



Wire Mesh
82



Sliding Lock Series
(For Aluminium Doors)
55



Sliding door clamp
58



Lever Lock
56



Door Lock
55



Bathroom Set
69

FLOOR HINGE SERIES

FLOOR HINGE SERIES



Accessories bottom pivot Top Pivot

Accessories bottom pivot Top Pivot

No.777



No.999

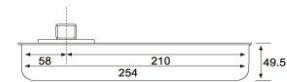
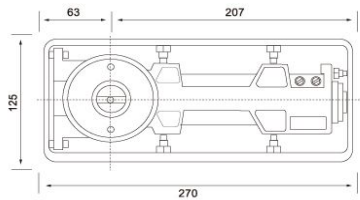

FLOOR HINGE SERIES

- DOOR SIZE x HEIGHT
1000X2200mm
- LOADING WEIGHT
90KG

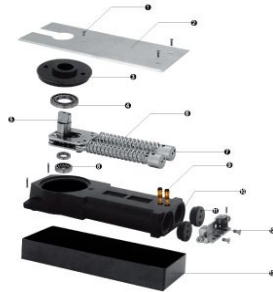
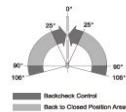

Cutaway view instruction

- 1 Fastening screw
- 2 Stainless plate
- 3 Bulge axle plaque
- 4 Pressure
- 5 Bulge axle
- 6 Spring
- 7 Piston
- 8 Pressure bearing
- 9 Velocity regulating
- 10 Mianbody container
- 11 Rear valve
- 12 Regulating valve Fastening screw
- 13 Cement box

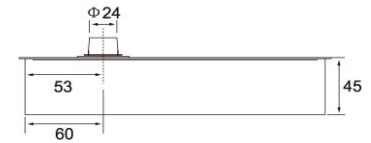
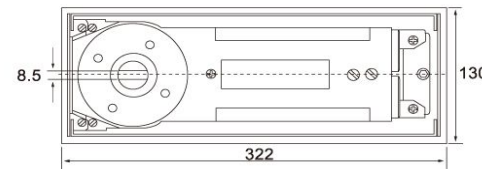

FLOOR HINGE SERIES

- DOOR SIZE x HEIGHT
1200X2300mm
- LOADING WEIGHT
135KG

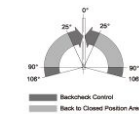



DOOR CLOSER SERIES

DOOR CLOSER SERIES



Door Closer

- DOOR SIZE x HEIGHT
600X1200mm
- LOADING WEIGHT
45~65KG

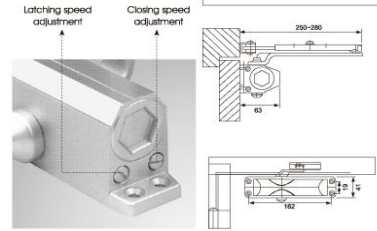

No.071



Conceal door closer

- DOOR SIZE x HEIGHT
600X1200mm
- LOADING WEIGHT
35~65KG

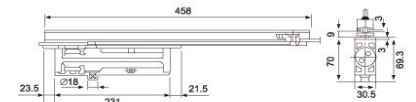

No.982



Hydraulic Patch Fitting - Conceal floor spring



Easy installation fast, smooth function
 From the pre buried or hole.
 Reduce the working hours, save version
 Smooth and comfortable feel
 Adjustable base: before and after the $\pm 3\text{mm}$, about $\pm 3\text{mm}$, $\pm 4^\circ$ rotation angle
 Function beyond the traditional spring from the pre buried or hole.
 For door weight: $\leq 100\text{kg}$
 Application of gate width: 750-1000mm
 For door thickness: 8-13mm
 Applicable environment temperature: -20°C - $+50^\circ\text{C}$
 Closing speed smoothly

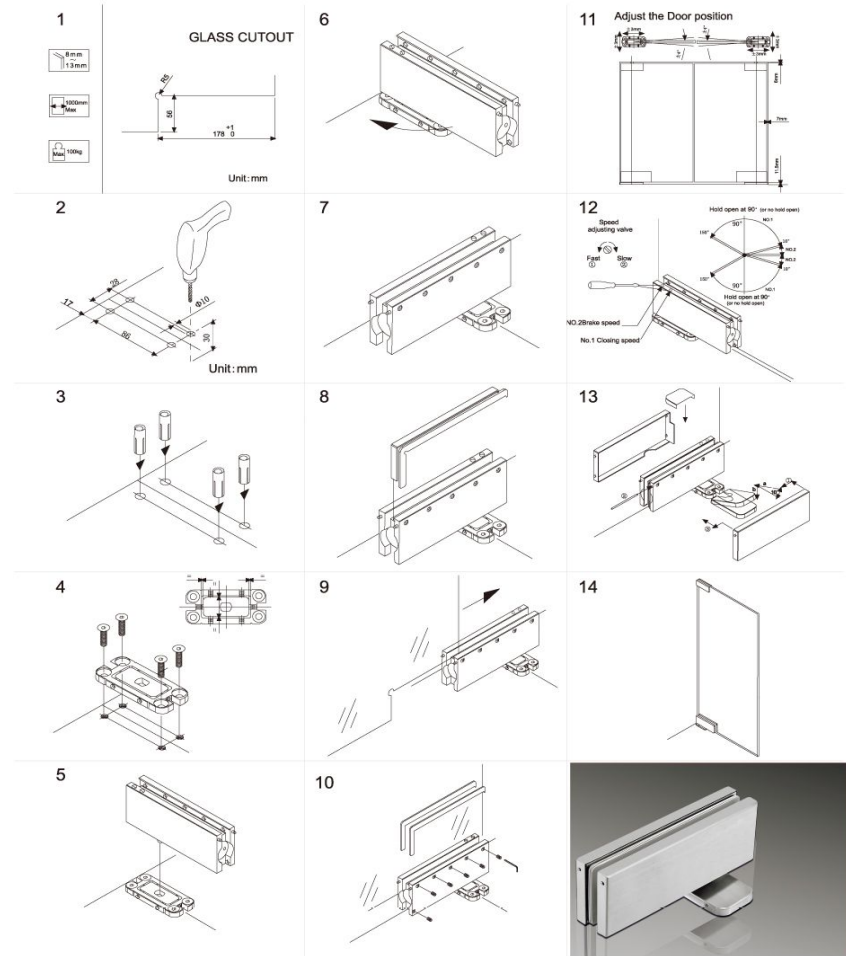

PATCH FITTING SERIES

PATCH FITTING SERIES



Bottom

It is Suitable for 10mm-12mm toughened glass
Finish: Satin SS

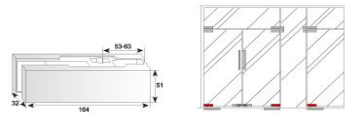

L-Big

It is Suitable for 10mm-12mm toughened glass
Finish: Satin SS

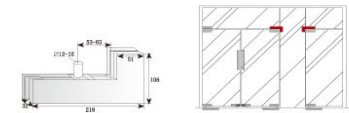

Top

It is Suitable for 10mm-12mm toughened glass
Finish: Satin SS

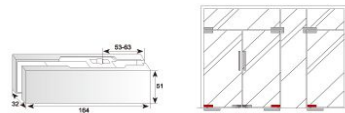

L-Small

It is Suitable for 10mm-12mm toughened glass.
Finish: Satin SS

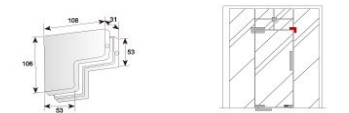

Lock

It is Suitable for 10mm-12mm toughened glass
Finish: Satin SS

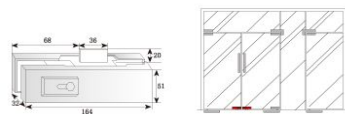

Single Connector

It is Suitable for 10mm-12mm toughened glass.
Finish: Satin SS



Top Pivot Plate

It is Suitable for 10mm-12mm toughened glass
Finish: Satin SS

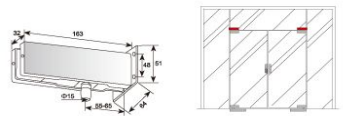

Double Connector

It is Suitable for 10mm-12mm toughened glass
Finish: Satin SS



SATIN FINISH GLASS CONNECTOR

CHROME FINISH GLASS CONNECTOR



0° Fix
 Material : Stainless steel
 It is Suitable for 10mm-12mm toughened glass.
 Finish: Satin stainless steel (SSS),
 Polished stainless steel (PSS)



0° Fix
 Material : Stainless steel
 It is Suitable for 10mm-12mm toughened glass.
 Finish: Satin stainless steel (SSS),
 Polished stainless steel (PSS)



90° Single
 Material : Stainless steel
 It is Suitable for 10mm-12mm toughened glass.
 Finish: Satin stainless steel (SSS),
 Polished stainless steel (PSS)



90° Double
 Material : Stainless steel
 It is Suitable for 10mm-12mm toughened glass.
 Finish: Satin stainless steel (SSS),
 Polished stainless steel (PSS)

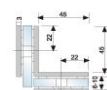

90° Single
 Material : Stainless steel
 It is Suitable for 10mm-12mm toughened glass.
 Finish: Satin stainless steel (SSS),
 Polished stainless steel (PSS)



90° Double
 Material : Stainless steel
 It is Suitable for 10mm-12mm toughened glass.
 Finish: Satin stainless steel (SSS),
 Polished stainless steel (PSS)



135° Single
 Material : Stainless steel
 It is Suitable for 10mm-12mm toughened glass.
 Finish: Satin stainless steel (SSS),
 Polished stainless steel (PSS)

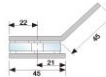

135° Double
 Material : Stainless steel
 It is Suitable for 10mm-12mm toughened glass.
 Finish: Satin stainless steel (SSS),
 Polished stainless steel (PSS)

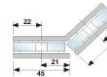

135° Single
 Material : Stainless steel
 It is Suitable for 10mm-12mm toughened glass.
 Finish: Satin stainless steel (SSS),
 Polished stainless steel (PSS)

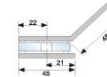

135° Double
 Material : Stainless steel
 It is Suitable for 10mm-12mm toughened glass.
 Finish: Satin stainless steel (SSS),
 Polished stainless steel (PSS)

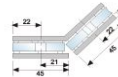

180° Single
 Material : Stainless steel
 It is Suitable for 10mm-12mm toughened glass.
 Finish: Satin stainless steel (SSS),
 Polished stainless steel (PSS)

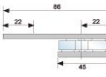

180° Double
 Material : Stainless steel
 It is Suitable for 10mm-12mm toughened glass.
 Finish: Satin stainless steel (SSS),
 Polished stainless steel (PSS)

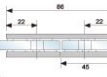

180° Single
 Material : Stainless steel
 It is Suitable for 10mm-12mm toughened glass.
 Finish: Satin stainless steel (SSS),
 Polished stainless steel (PSS)

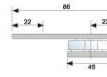

180° Double
 Material : Stainless steel
 It is Suitable for 10mm-12mm toughened glass.
 Finish: Satin stainless steel (SSS),
 Polished stainless steel (PSS)

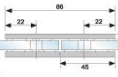



SN FINISH SHOWER HINGE SERIES



90° Wall to Glass

It is Suitable for 10mm-12mm toughened glass.
 Material: Zinc alloy
 Finish: Satin stainless steel (SSS), Polished stainless steel (PSS).

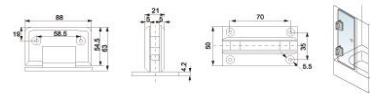

135° Glass to Glass

It is Suitable for 10mm-12mm toughened glass.
 Material: Zinc alloy
 Finish: Satin stainless steel (SSS), Polished stainless steel (PSS).

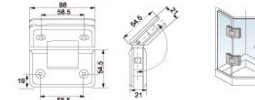

180° Glass to Glass

It is Suitable for 10mm-12mm toughened glass.
 Material: Zinc alloy
 Finish: Satin stainless steel (SSS), Polished stainless steel (PSS).

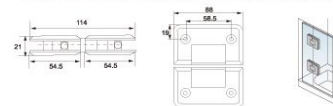

90° Glass to Glass

It is Suitable for 10mm-12mm toughened glass.
 Material: Zinc alloy
 Finish: Satin stainless steel (SSS), Polished stainless steel (PSS).

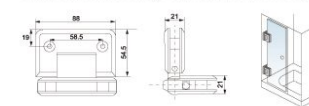

0° Fix Clip

It is Suitable for 10mm-12mm toughened glass.
 Material: Zinc alloy
 Finish: Satin stainless steel (SSS), Polished stainless steel (PSS).

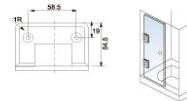



CP FINISH SHOWER HINGE SERIES



90° Wall to Glass

It is Suitable for 10mm-12mm toughened glass.
 Material: Zinc alloy
 Finish: Satin stainless steel (SSS), Polished stainless steel (PSS).

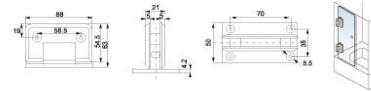

135° Glass to Glass

It is Suitable for 10mm-12mm toughened glass.
 Material: Zinc alloy
 Finish: Satin stainless steel (SSS), Polished stainless steel (PSS).

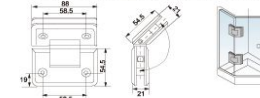

180° Glass to Glass

It is Suitable for 10mm-12mm toughened glass.
 Material: Zinc alloy
 Finish: Satin stainless steel (SSS), Polished stainless steel (PSS).

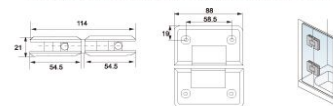

90° Glass to Glass

It is Suitable for 10mm-12mm toughened glass.
 Material: Zinc alloy
 Finish: Satin stainless steel (SSS), Polished stainless steel (PSS).

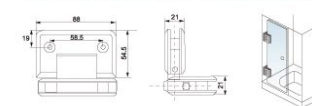

0° Fix Clip

It is Suitable for 10mm-12mm toughened glass.
 Material: Zinc alloy
 Finish: Satin stainless steel (SSS), Polished stainless steel (PSS).

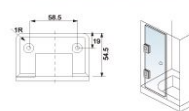

GLASS DOOR LOCK SERIES

GLASS DOOR LOCK SERIES SUS COVER WITH BRASS COMPUTER KEY



No.302 Slide door automatic lock



Material: high strength structural steel or zinc aluminum alloy or stainless steel.
Features: independent key design, beautiful and durable, applicable for 10mm-12mm thick frameless toughed glass double slide door.
Finish: Satin stainless steel.
Note: it doesn't need to punch the glass.

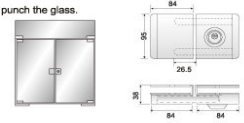

No.301B Single door lock



Material: high strength structural steel or zinc aluminum alloy or stainless steel.
Features: independent arc design, beautiful and durable, applicable for 10mm-12mm thick frameless toughed glass double slide door.
Finish: Satin stainless steel.
Note: it doesn't need to punch the glass.

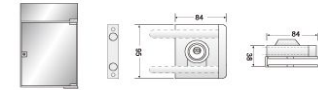

No.313 Double door single side lock



Material: Apply high strength structural steel or stainless steel.
Features: independent arc appearance design, beautiful and durable, applicable for 10mm-12mm thick frameless toughed glass double slide door.
Finish: Satin stainless steel.
Note: it doesn't need to punch the glass.

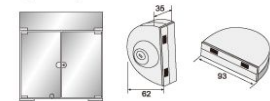

No.318 Double door lock with knob



Material: Apply high strength structural steel or stainless steel.
Features: independent arc appearance design, beautiful and durable, applicable for 10mm-12mm thick frameless toughed glass double slide door.
Finish: Satin stainless steel.
Note: it doesn't need to punch the glass.

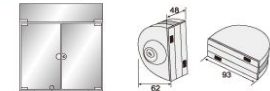



No.312 Slide door automatic lock

Material: Apply high strength structural steel or stainless steel.
Features: Independent arc appearance design, beautiful and durable, applicable for 10mm-12mm thick frameless toughed glass double slide door.
Finish: Satin stainless steel.
Note: It doesn't need to punch the glass.

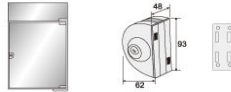

No.362 Double door single hook lock

Material: Apply high strength structural steel or stainless steel.
Features: Independent arc appearance design, beautiful and durable, applicable for 10mm-12mm thick frameless toughed glass double slide door.
Finish: Satin stainless steel.
Note: It doesn't need to punch the glass.



No.603 Slide door automatic lock

Material: Apply high strength structural steel or stainless steel.
Features: Independent arc appearance design, beautiful and durable, applicable for 10mm-12mm thick frameless toughed glass double slide door.
Finish: Satin stainless steel.
Note: It doesn't need to punch the glass.



No.363 Single door double hook lock

Material: Apply high strength structural steel or stainless steel.
Features: Independent arc appearance design, beautiful and durable, applicable for 10mm-12mm thick frameless toughed glass double slide door.
Finish: Satin stainless steel.
Note: It doesn't need to punch the glass.



No.608 Mini double lock

Material: Apply high strength structural steel or stainless steel.
Features: Independent arc appearance design, beautiful and durable, applicable for 10mm-12mm thick frameless toughed glass double slide door.
Finish: Satin stainless steel.
Note: It doesn't need to punch the glass.

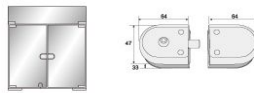

No.368 Double door double hook lock

Material: Apply high strength structural steel or stainless steel.
Features: Independent arc appearance design, beautiful and durable, applicable for 10mm-12mm thick frameless toughed glass double slide door.
Finish: Satin stainless steel.
Note: It doesn't need to punch the glass.



No.361 Single door single hook lock

Material: Apply high strength structural steel or stainless steel.
Features: Independent arc appearance design, beautiful and durable, applicable for 10mm-12mm thick frameless toughed glass double slide door.
Finish: Satin stainless steel.
Note: It doesn't need to punch the glass.

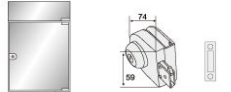

GLASS DOOR HANDLE SERIES



GLASS DOOR HANDLE SERIES



Handle with lock (round)

Available sizes:
38x1500mm



Handle with lock (square)

Available sizes:
25x38x1500mm



GLASS DOOR HANDLE SERIES

GLASS DOOR HANDLE SERIES



No.H
Available Size(mm):
25x250mm
25x300mm
32x450mm
32x600mm
38x900mm



No.D
Available sizes:
25x250mm
25x300mm
32x450mm
32x600mm



No.S
Available sizes:
25x250mm
32x450mm
32x600mm



No.227
Available sizes:
25x38x300mm
25x38x450mm
25x38x600mm



No.786
Available sizes:
30X15X450mm
30X15X800mm
30X15X800mm



No.671
Available sizes:
32x300mm
32x450mm
38x600mm

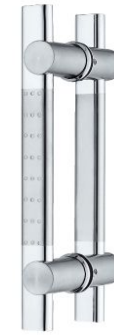

No.39-A
Available sizes:
15x30x300mm
25x45x450mm
25x45x600mm



No.164
Available SIZE(mm):
38x19x300mm
38x19x450mm
38x19x600mm



No.440
Available sizes:
25x200x400mm



No.330
Available sizes:
19x200x400mm

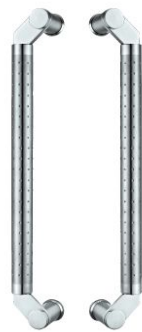

No.069
Available sizes:
25x300mm
32x450mm
32x600mm



No.139
Available sizes:
25x300mm
32x450mm
32x600mm



No.159
Available sizes:
28x300mm
38x450mm
38x600mm



No.040
Available sizes:
25x300mm
32x450mm
32x600mm



No.059
Available sizes:
32x300mm
38x450mm
38x600mm

GLASS DOOR HANDLE SERIES



No. 8802
Available sizes:
300mm
450mm
600mm



No. 011
Available sizes:
32x300mm
32x450mm
38x600mm

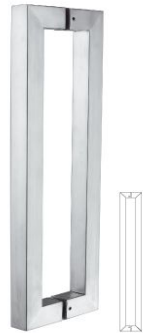

No. 033
Available sizes:
25x38x300mm
25x38x450mm
25x38x600mm
25x38x900mm



No. 041
Available sizes:
38x25x450mm
38x25x600mm



No. 634
Available sizes:
300mm
450mm
600mm

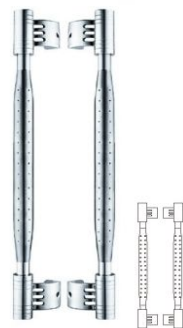

No. 222
Available sizes:
32x300mm
32x450mm
38x600mm



No. 777
Available sizes:
38x38x300mm
38x38x450mm
38x38x600mm



No. 145
Available sizes:
25x300mm
32x450mm
32x600mm



DECORATIVE
HANDLE SERIES

DECORATIVE HANDLE SERIES

DECORATIVE HANDLE SERIES



DH-931
Material: Aluminum
color: AB
Size:
35x32x420mm



DH-932
Material: Aluminum
color: AB
Size:
35x32x420mm



DH-933
Material: Aluminum
color: AB
Size:
35x32x420mm



DH-934
Material: Aluminum
color: AB
Size:
35x32x420mm

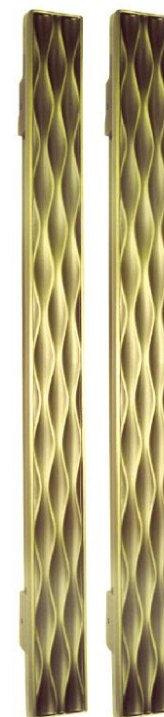

DH-935
Material: Aluminum
color: AB
Size:
35x32x420mm



700
Material: Stainless steel
color: AB
Size:
20x60x650mm



DECORATIVE HANDLE SERIES

DECORATIVE HANDLE SERIES



DH-821
Material: Aluminum
Finish: AB & SN
Size: 450mm



DH-822
Material: Aluminum
Finish: AB & SN
Size: 450mm



DH-823
Material: Aluminum
Finish: AB & SN
Size: 450mm



No.8817
Material: Aluminum
color: AB
Size:
40x450mm
40x600mm



No.8814
Material: Aluminum
color: AB
Size:
40x450mm
40x600mm





No.382
Material:Aluminum
color:AB
Size:
160x20x300mm



No.378
Material:Aluminum
color:AB
Size:
160x20x300mm



No.402
Material:Aluminum
color:AB
Size:
400x20mm



No.376
Material:Aluminum
color:AB
Size:
180x180x12mm



No.383
Material:Aluminum
color:AB
Size:
160x15x300mm

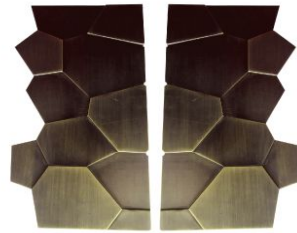

No.384
Material:Aluminum
color:AB
Size:
225x15x400mm



No.377
Material:Aluminum
color:AB
Size:
140x440x10mm



No.373
Material:Aluminum
color:AB
Size:
120x250x10mm

DECORATIVE HANDLE SERIES

DECORATIVE HANDLE SERIES



Elephant
Size:500mm & 800mm
Finish:AB

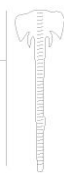

No.510
Material:Aluminum
color:AB
Size:
75x285x12mm



No.511
Material:Aluminum
color:AB
Size:
225x20x1080mm



701
Material:Aluminum
Finish: AB & SN
Size:
12X120X600mm



702
Material:Stainless steel
Finish:GOLD & CP
Size:
600mm



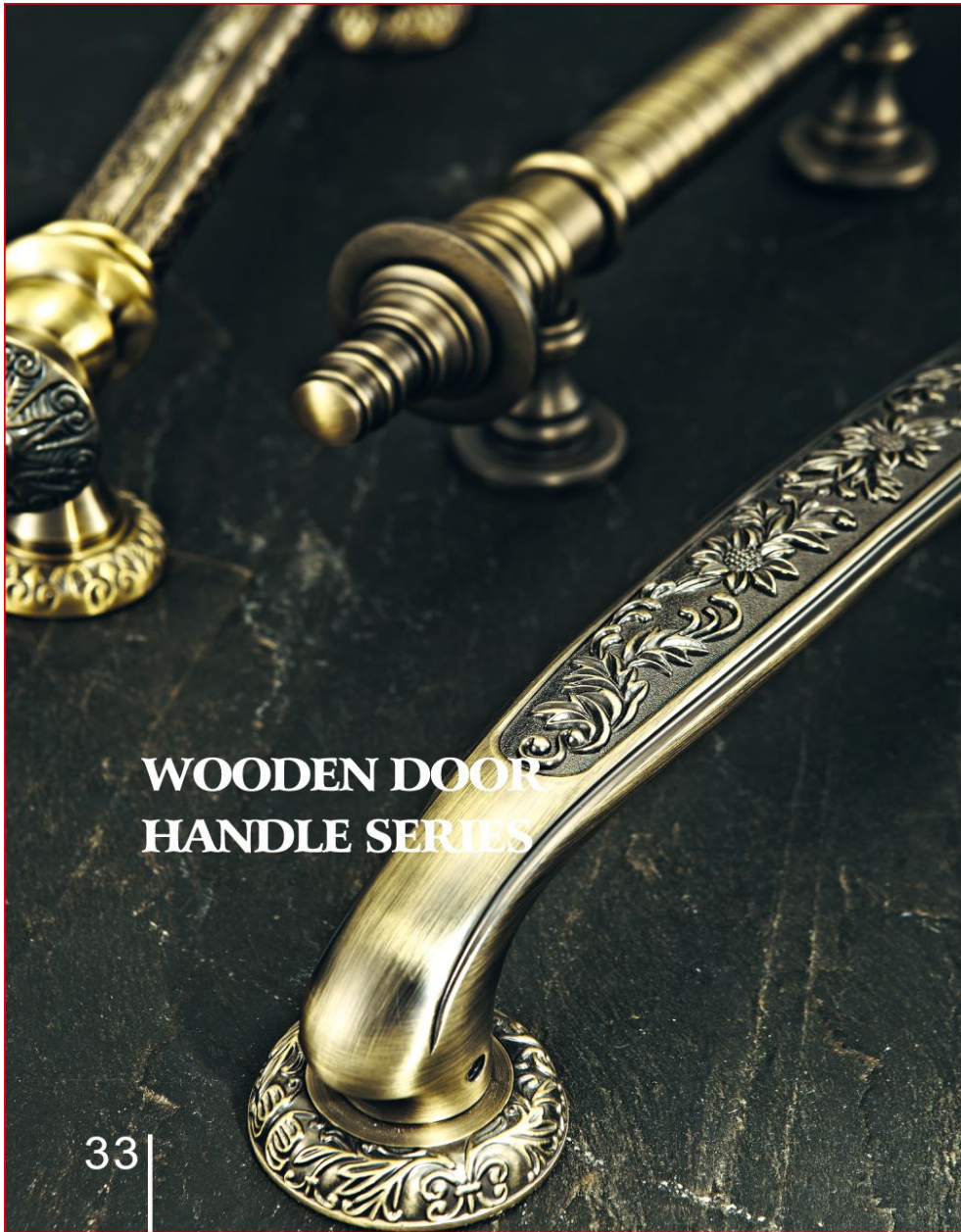

**WOODEN DOOR
HANDLE SERIES**

WOODEN PULL HANDLE SERIES



NO.LION-720

Finish : SN



NO.LION-720

Finish : AB



NO.711

Finish : CP + Marble



NO.711

Finish : CP + SN

WOODEN PULL HANDLE SERIES

WOODEN PULL HANDLE SERIES



NO.712
Finish : CP + Marble



NO.712
Finish : CP + SN



NO.714
Finish : CP



NO.714
Finish : AB



NO.713
Finish : CP



NO.713
Finish : AB



NO.715
Finish : CP



NO.715
Finish : AB

WOODEN PULL HANDLE SERIES



NO.717
Finish : AB



NO.718
Finish : AB



NO.719
Finish : SN



NO.719
Finish : AB



NO.167
Color: AB
Size: 260-320mm



NO.167
Color: SN
Size: 260-320mm



NO. 716
Finish: CP + MARBLE



WOODEN PULL HANDLE SERIES



WOODEN PULL HANDLE SERIES

WOODEN PULL HANDLE SERIES



NO.162
Color: SN
Size: 245-300mm



NO.162
Color: AB
Size: 245-300mm



NO.182
Color: SN
Size: 250-300mm



NO.182
Color: AB
Size: 250-300mm



NO.165
Color: SN
Size: 250-305mm



NO.165
Color: AB
Size: 250-305mm



NO.175-B
Color: SN
Size: 255-390mm



NO.175-B
Color: AB
Size: 255-390mm

WOODEN PULL HANDLE SERIES

WOODEN PULL HANDLE SERIES



NO.168
Color: SN
Size: 225-350mm



NO.168
Color: AB
Size: 225-350mm



NO.216
Color: SN
Size: 250-300mm



NO.216
Color: AB
Size: 250-300mm



NO.213
Color: SN
Size: 250-300mm



NO.213
Color: AB
Size: 250-300mm



NO.180
Color: SN
Size: 245-315mm



NO.180
Color: AB
Size: 245-315mm

WOODEN PULL HANDLE SERIES

WOODEN PULL HANDLE SERIES



NO.203
Color: SN
Size: 250-300mm



NO.203
Color: AB
Size: 250-300mm



NO.10
Color: SN
Size: 255-305mm



NO.10
Color: AB
Size: 255-305mm



NO.209
Color: SN
Size: 250-300mm



NO.209
Color: AB
Size: 250-300mm



NO.5023
Color: SN
Size: 242-295mm



NO.115
Color: SN
Size: 242-300mm

WOODEN PULL HANDLE SERIES

WOODEN PULL HANDLE SERIES



NO.208
Color: SN
Size: 250-300mm



NO.208
Color: AB
Size: 250-300mm



NO.107
Color: SN
Size: 165-210mm



NO.107
Color: AB
Size: 165-210mm



NO.214
Color: SN
Size: 250-300mm



NO.214
Color: AB
Size: 250-300mm



NO.130
Color: SN
Size: 220-270mm



NO.105
Color: SN
Size: 250-310mm

WOODEN PULL HANDLE SERIES

WOODEN PULL HANDLE SERIES



NO.D-22
Color: SN
Size: 250-310mm



NO.D-25
Color:SN
Size:250-310mm



NO.112
Color: SN
Size: 235-285mm



NO.112
Color: AB
Size: 235-285mm



NO.D-24
Color: SN
Size: 250-310mm



NO.D-27
Color: SN
Size:250-310mm



NO.133
Color: SN
Size: 250-300mm



NO.5028
Color: SN
Size: 195-255mm

CURTAIN BRACKETS SERIES



CURTAIN BRACKETS SERIES



C-2865_{AB}



C-2865_{SN}



C-2865_{AC}



C-2810_{AB}



C-2810_{SN}



C-2810_{AC}

CURTAIN BRACKETS SERIES



C-2818 _{AC}



C-2818 _{SN}



C-2818 _{AB}



C-2813 _{AC}



C-2813 _{SN}



C-2813 _{AB}

CURTAIN BRACKETS SERIES



C-2826 _{AC}



C-2826 _{SN}



C-2826 _{AB}



C-2249 _{AC}



C-2249 _{SN}



C-2249 _{AB}

CURTAIN BRACKETS SERIES



C-2231 _{AC}



C-2231 _{SN}



C-2231 _{AB}



C-2828 _{AC}



C-2828 _{SN}



C-2828 _{AB}



TM-A-1 _{SN}



TM-A-1 _{AC}



TM-A-1 _{AB}

SHELF BRACKET SERIES



Thickness:1.5mm
Size: 150mm 200mm 250mm
300mm 350mm 400mm

JB030



Regular & Heavy

Thickness:1.5mm
Size: 1.8m 2.4m

JB002



Double

Thickness:1.5mm
Size: 1.8m 2.4m

JB001

SLIDING LOCK / DOOR LOCK SERIES

LEVER LOCK SERIES



41055 Lock



NO.5791

COMPUTER KEY



LL-101
FINISH:SN



LL-101
FINISH:AB



41054 Lock



Night Latch(NO.306)



LL-102
FINISH:SN



LL-102
FINISH:AB



99 Lock



Night Latch(NO.333)



LL-103
FINISH:SN



LL-103
FINISH:AB

DOOR FITTING SERIES



Sliding door Fitting



Door Viewer

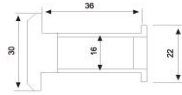

Finish: Gold
Materials: Zinc Alloy
Available for: To see Everyting Outside



Door Viewer

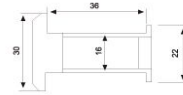

Finish: Gold
Materials: Zinc Alloy
Available for: To see Everyting Outside



Sliding door (round)



Sliding door (square)



xx-1



xx-2



xxx-505



xx-911



DOOR HOLDER

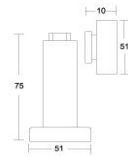

Finish:AB
Materials: Zinc Alloy
Available for: Rooms Doors



DOOR HOLDER

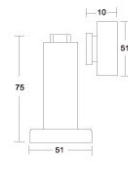

Finish:SN
Materials: Zinc Alloy
Available for: Rooms Doors

SS GLASS HOLLOW STUD



- Material: Stainless steel
- Finishing: Polished Stainless Steel(PSS)
Satin Stainless Steel(SSS)

SIZES AVAILABLE	
19MM	19, 25, 38, 50, 75, 100, 150
25MM	25, 38, 50, 75, 100, 150
30MM	30, 50, 100, 150, 200, 300

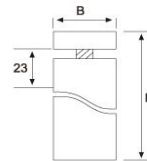

BATHROOM PIPE CONNECTOR



Wall to Pipe
Materials: Brass
Finish: CP
Size: $\varnothing 19 \times \varnothing 25$



Pipe to Glass
Materials: Brass
Finish: CP
Size: $\varnothing 19 \times \varnothing 25$



Pipe to Pipe
Materials: Brass
Finish: CP
Size: $\varnothing 19 \times \varnothing 25$

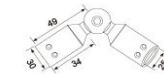
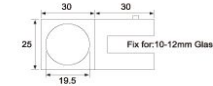

SLIDING DOOR HANDLE & KNOB



Round
Material: Brass
Finish: CP & SN



Knob
Material: Zinc & Aluminum
Finish: CP & SN



Square
Material: Brass
Finish: CP & SN

GLASS SHELF BUTTON



NO.1
Finish: Nickel
Materials: Zinc alloy
Available for: All kinds of glass tier and wooden plywood



NO.8
Finish: Nickel
Materials: Zinc alloy
Available for: All kinds of glass tier and wooden plywood



NO.2
Finish: Nickel
Materials: Zinc alloy
Available for: All kinds of glass tier and wooden plywood



NO.9
Finish: Nickel
Materials: Zinc alloy
Available for: All kinds of glass tier and wooden plywood



NO.3
Finish: Nickel
Materials: Zinc alloy
Available for: All kinds of glass tier and wooden plywood



NO.10
Finish: Nickel
Materials: Zinc alloy
Available for: All kinds of glass tier and wooden plywood



NO.4
Finish: Nickel
Materials: Zinc alloy
Available for: All kinds of glass tier and wooden plywood



NO.11
Finish: Nickel
Materials: Zinc alloy
Available for: All kinds of glass tier and wooden plywood



NO.5
Finish: Nickel
Materials: Zinc alloy
Available for: All kinds of glass tier and wooden plywood



NO.12 (Small)
Finish: Nickel
Materials: Zinc alloy
Available for: All kinds of glass tier and wooden plywood



NO.6
Finish: Nickel
Materials: Zinc alloy
Available for: All kinds of glass tier and wooden plywood



NO.12 (Big)
Finish: Nickel
Materials: Zinc alloy
Available for: All kinds of glass tier and wooden plywood

HARDWARE FITTING SERIES



Metal Keyboard Tray



Keyboard Channel
27mm & 35mm

DEAD LOCK 4 WAY



DEAD LOCK 2 WAY

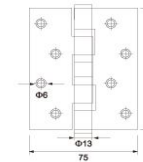

M.S.Hinges (GP finish)
4x3x3.0 & 5x3x3.0
Finish: Gold
Materials: Iron



It is Suitable for 5mm-8mm toughened glass
Finish: Satin SS

Glass Hinges

FLOOR HINGE SERIES



No.123

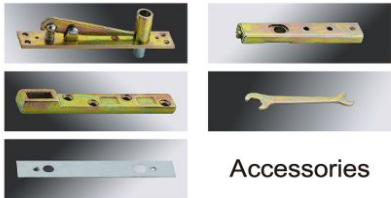

Accessories

- Standard configuration**
- Finish: Drawbench
 - Materials: Pressed iron
 - ➔ Max door width: 1100mm
 - ⚖ Max door weight: 100-180kg
 - 🕒 Available for: Steel and wooden doors 8-12 toughened glass door
 - ⚙ Function: Two way open at 120° and exact stop at 90°
 - ⚙ Features: Switching for 500,000 times

Assembling picture of floor hinge series

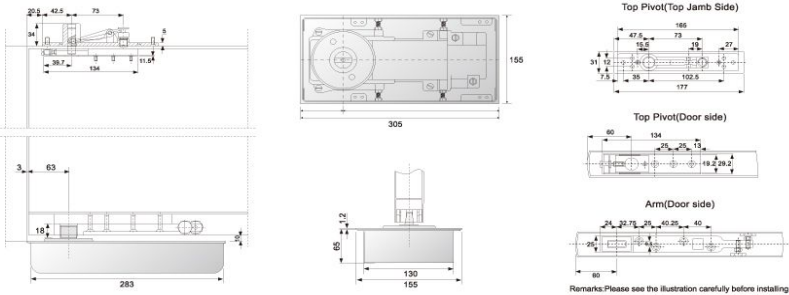

DOOR CLOSER SERIES



Use for heavy wind and heavy weight door

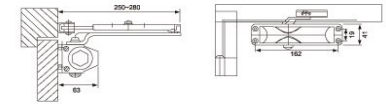

Three Speed Adjusting Doorcloser

The max width of door is 900-1800, suitable for the door weight of 50-90Kg.
 The adjustable section of closing speed is 180°-20°, the adjustable section of locking is 20°-0°
 The painting plastic moving arm can protect from eroding; the excellent closing can protect from oil leakage.
 Super aluminum alloy casting machine and the three layers of brightness painting will protect it from oxygenation.
 Two hydraulic pressure valves control two sections of door closing separately.
 The high-carbon steel axis and rack work smart and less transfiguer being managed through high channel adjusting.
 With a function of stopping at anchor point of 90° and no anchor point of 180°.
 Distance: 168mmx19mm

No.165



PATCH FITTING SERIES



PATCH FITTING SERIES

PYCH

2014-2015

Top pivot

Material: 304 Stainless steel
Finish : Satin stainless steel

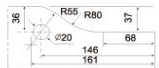
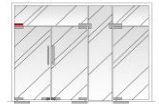
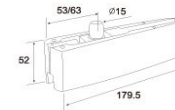

L-Big

Material: 304 Stainless steel
Finish : Satin stainless steel

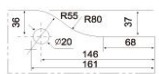
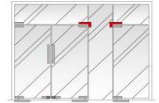
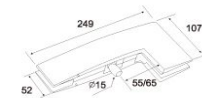

Bottom

Material: 304 Stainless steel
Finish : Satin stainless steel

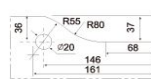
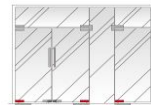

Top

Material: 304 Stainless steel
Finish : Satin stainless steel

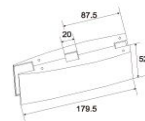

Bottom lock

Material: 304 Stainless steel
Finish : Satin stainless steel

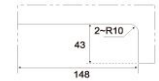
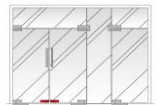
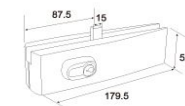

L-Small

Material: 304 Stainless steel
Finish : Satin stainless steel

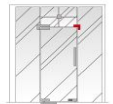
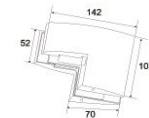



BRASS SHOWER HINGE (C.P. FINISH)



135° Glass to glass

Suitable for installing glass door 800-1000mm wide, 8-12mm thick
Material: Brass
Finishing: Chrome

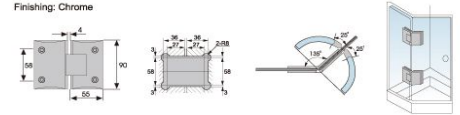

180° Glass to glass

Suitable for installing glass door 800-1000mm wide, 8-12mm thick
Material: Brass
Finishing: Chrome

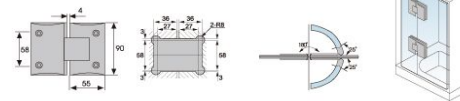

0° Fix shower hinge

Suitable for installing glass door 800-1000mm wide, 8-12mm thick
Material: Brass
Finishing: Chrome

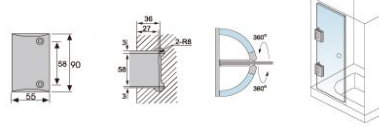

90° Glass to glass

Suitable for installing glass door 800-1000mm wide, 8-12mm thick
Material: Brass
Finishing: Chrome

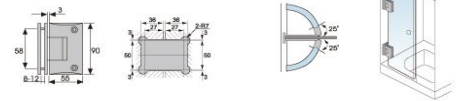

90° Wall to glass

Suitable for installing glass door 800-1000mm wide, 8-12mm thick
Material: Brass
Finishing: Chrome

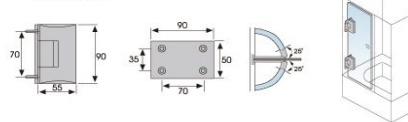

Moving shower hinge

Suitable for installing glass door 800-1000mm wide, 8-12mm thick
Material: Zinc alloy
Finishing: Chrome

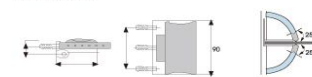

GLASS CONNECTOR BRASS+SS (C.P.FINISH)

GLASS CONNECTOR BRASS+SS (C.P.FINISH)



0° Fixing

It is Suitable for 8mm-12mm toughened glass.
Material: Brass+S.S
Finishing: Chrome

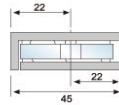

90° Single

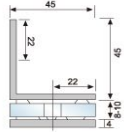

It is Suitable for 8mm-12mm toughened glass.
Material: Brass+S.S
Finishing: Chrome



90° Double

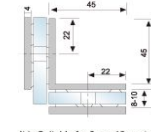

It is Suitable for 8mm-12mm toughened glass.
Material: Brass+S.S
Finishing: Chrome



135° Single

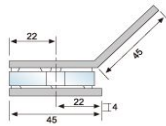

It is Suitable for 8mm-12mm toughened glass.
Material: Brass+S.S
Finishing: Chrome



135° Double

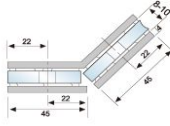

It is Suitable for 8mm-12mm toughened glass.
Material: Brass+S.S
Finishing: Chrome



180° Single

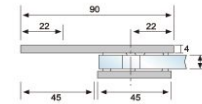

It is Suitable for 8mm-12mm toughened glass.
Material: Brass+S.S
Finishing: Chrome



180° Double

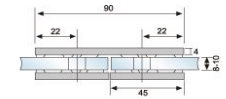

It is Suitable for 8mm-12mm toughened glass.
Material: Brass+S.S
Finishing: Chrome

LOCK SERIES



NO.5791

Material : 304 SUS
Brass computer key



Drawer Lock
(Computer Key)



BATHROOM ACCESSORIES SERIES



PYCH BATHROOM ACCESSORIES 8100 SERIES



8124
Tower Bar



8188
Tower Shelf



8154
Robe Hook



8159
Soap Dish



8160
Towel Ring



8151
Paper Holder



8158
Tumbler Holder



8152
Soap Dispenser



BATHROOM ACCESSORIES SERIES



PYCH BATHROOM ACCESSORIES 5300 SERIES



5324
Tower Bar



5324
Tower Shelf



5354
Robe Hook



5360
Towel Ring



5359
Soap Dish



5358
Tumbler Holder



5352
Soap Dispenser



88700 SERIES



88724
Tower Bar



88788
Tower Shelf



88754
Robe Hook



88751
Paper Holder



88760
Towel Ring



88759
Soap Dish



88758
Tumbler Holder



88752
Soap Dispenser



BATHROOM ACCESSORIES SERIES



PYCH BATHROOM ACCESSORIES 6500 SERIES



6501
Tower Bar



6504
Tower Shelf



6513
Robe Hook



6508
Paper Holder



6509
Towel Ring



6511
Soap Dish



6510
Tumbler Holder



6507
Soap Dispenser



BATHROOM ACCESSORIES SERIES



PYCH BATHROOM ACCESSORIES 11700 SERIES



11724
Tower Bar



11788
Tower Shelf



11754
Robe Hook



11760
Towel Ring



11751
Paper Holder



11759
Soap Dish



11758
Tumbler Holder



11752
Soap Dispenser



85600 SERIES



85620
Tower Bar



85621
Tower Shelf



85682
Robe Hook



85680
Towel Ring



85686
Paper Holder



85685
Soap Dish



85684
Tumbler Holder



85685F
Soap Dispenser



BATHROOM ACCESSORIES



Shampo Holder



Cloth Holder



Mirror

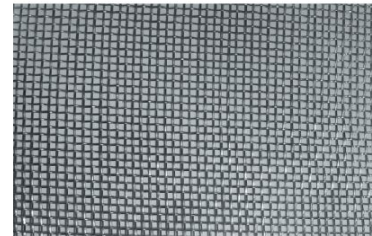
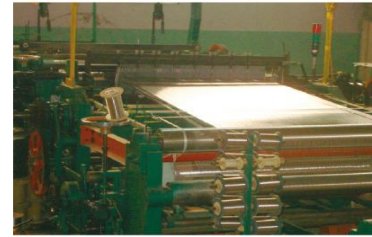

Size:18X16 ss finish
Available size: 2 , 2.5 , 3 ,3.5 , 3.75, 4 , 5 ft



Size:18X16 Black finish
Available size: 2 , 2.5 , 3 ,3.5 , 3.75, 4 , 5 ft



Size:14X14 Black finish
Available size: 2 , 2.5 , 3 ,3.5 , 3.75, 4 , 5 ft

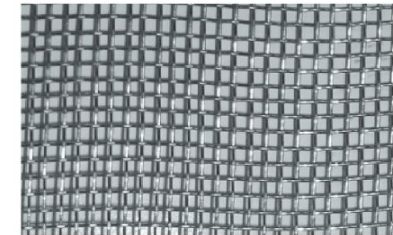

Size:14X14 ss finish
Available size: 2 , 2.5 , 3 ,3.5 , 3.75, 4 , 5 ft