



Smart and Reliable Pumping Solutions



Crompton Greaves Consumer Electricals Ltd.

w.e.f Feb 2021 ▶▶



Mini Neo



Monoblock



Openwell



Pressure Booster



Sewage Pump



Borewell

Pumps Business

Crompton Greaves Consumer Electricals Limited, is the leading manufacturer of all types of pumps suitable for handling water, finding applications in Agricultural, Residential and Commercial Sectors.

Pumps manufactured by CGCEL are customer friendly and are very reliable. CGCEL has an ever increasing range of energy efficient pumps.



Consecutively "Superbrand" for Last Seven Years



Advanced Pump Testing Setup and Calibration Lab



State of the Art Manufacturing Facility



w.e.f Feb 2021 ▶▶

Contents**Residential Pumps Range**

| | |
|---|----|
| Mini Series Self Priming Regenerative Pumps - Premium Series | 01 |
| Mini Series Self Priming Regenerative Pumps - Standard & Economy Series | 04 |
| Aquagold Series Self Priming Regenerative Pumps | 08 |
| Flomax Series Self Priming Regenerative Pumps | 10 |
| DMB / CMB Series Self Priming Regenerative Pumps | 12 |
| SWJ / TWJ Series Self Priming Shallow Well Jet Pumps | 15 |
| Centrifugal Deep Well Jet Pumps | 18 |
| 3W Series Borewell Submersible Water filled Pumps | 21 |
| 4W Series Borewell Submersible Water filled Pumps | 24 |
| 3VO / 4VO Series Borewell Submersible Oil filled Pumps | 31 |
| 4WSS Series Stainless Steel Borewell Submersible Pumps | 36 |
| Centrifugal Openwell Submersible Pumps (OW Series) | 39 |
| Compressor Pumps | 42 |
| Single Phase Control Panels Crompton ARMOR Series | 44 |
| Single Phase Control Panels (NDCP/CDCP & NODCP/CODCP Series) | 46 |

Agricultural Pumps Range

| | |
|--|----|
| 4W Series Borewell Submersible Pumps | 50 |
| 100W Series Borewell Submersible Pumps | 56 |
| 4VO Series Borewell Submersible Pumps | 62 |
| 4CSS Series Stainless Steel Borewell Submersible Pumps | 64 |
| 5W / 125W Series Borewell Submersible Pumps | 67 |

w.e.f Feb 2021 ▶▶

Contents**Agricultural Pumps Range**

| | |
|---|-----|
| 5CSS Series Stainless Steel Borewell Submersible Pumps | 71 |
| 6W Ultima Series Borewell Submersible Pumps | 74 |
| 6W Magna Series Borewell Submersible Pumps | 82 |
| 6W/150W Series Borewell Submersible Pumps | 90 |
| 650CS Series Stainless Steel Borewell Submersible Pumps | 97 |
| V6-V7/ V6-V8 Janta Series Borewell Submersible Pumps | 102 |
| 8W Series Borewell Submersible Pumps | 108 |
| 10" Borewell Submersible Pumps | 113 |
| MB & MI Series Centrifugal Monoset Pumps | 117 |
| MBG Series Centrifugal Monoset Pumps | 124 |
| Openwell Submersible Pumps - Ultima Series | 132 |
| Openwell Submersible Pumps (Horizontal) | 135 |
| Openwell Submersible Pumps (Vertical) | 142 |

Speciality Pumps Range

| | |
|--|-----|
| Pressure Booster Pumps | 147 |
| Horizontal Multistage Pumps (CHM & MSMB Series) | 151 |
| Sewage Submersible Pumps (STPM, STPC & CCP Series) | 154 |
| Circulating Inline Pumps (CIL Series) | 158 |
| Dewatering Monobloc Pumps | 160 |
| Technical Data | 163 |

Crompton

Pressure in pipeline Not in your life



RESIDENTIAL PUMPS EXPLORER

Mini Series Self Priming Regenerative Pumps - Premium Series



Stainless Steel Insert SS-304

Provided Stainless Steel insert for corrosion free & stuck free operation

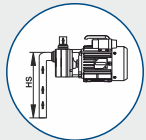

High Suction Capacity

Instant suction, Up to 8.0 meters suction lift

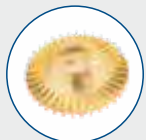

High Grade Brass Impeller

High quality forged brass impeller for longer life



F Class Insulation

High grade F class insulation paper used for higher reliability



Robust & Sturdy Design

Offers rust free & stuck free operation



High Grade Electrical Stamping

Reduces electrical losses & improves pump efficiency



Easy for Maintenance

Simple construction, easily replaceable wear & tear parts



IP 55 Protection

High Protection from water splashing & solid particle

Technical Specifications:

- 0.5 HP & 1.0 HP (0.37kW & 0.75kW)
- Rated voltage: 220V
- Voltage range: 180V-260V (1PH)
- Rated Frequency: 50Hz
- Pipe size: 25mm X 25mm
- Max. head: Up to 55 meters
- Max. discharge: Up to 4280 LPH

Application:

- Water supply to residential bungalows, garages, flats, dairies, hotels, laundries, club, hospitals etc
- Gardening
- Lawn sprinklers
- Ornamental fountains
- Water feeding in solar system
- Booster applications



Performance Curve:

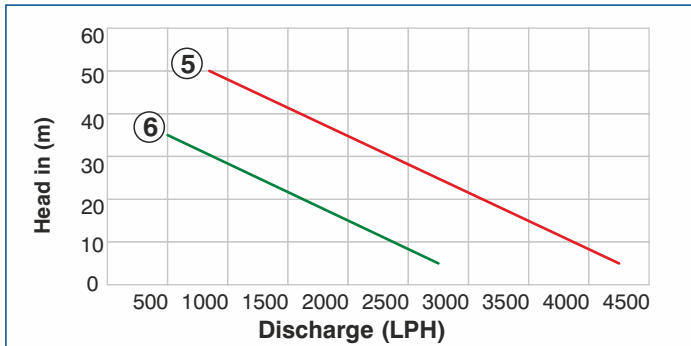
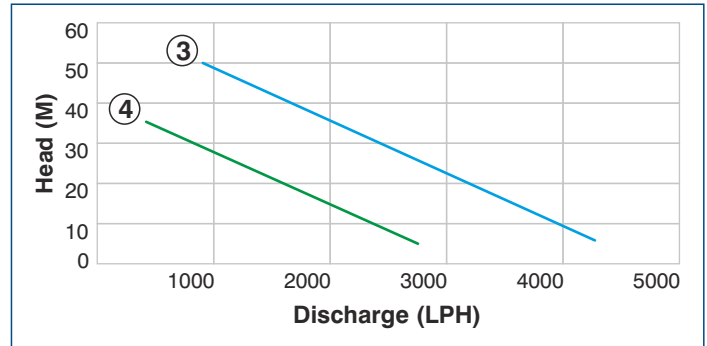
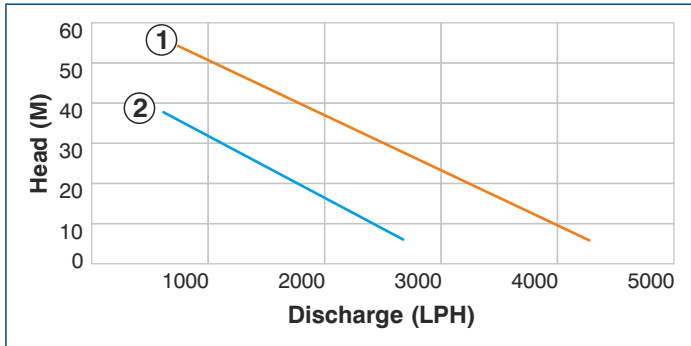

Performance Table:

| Sr. No. | Rating | Motor | | Pipe Size mm | Head in Meter | | | | | | | |
|---------|-----------------|-------|-----|--------------|------------------|------|------|------|------|------|------|-----|
| | | kW | HP | | 6 | 12 | 18 | 24 | 27 | 36 | 42 | 55 |
| | | | | | Discharge in LPH | | | | | | | |
| * 1 | MINI PACIFIC I | 0.75 | 1.0 | 25 X 25 | 4280 | 3880 | 3490 | 3020 | 2800 | 2120 | 1700 | 700 |
| * 2 | MINI PACIFIC II | 0.37 | 0.5 | 25 X 25 | 2760 | 2340 | 1890 | 1400 | 1150 | 640 | - | - |

| Sr. No. | Rating | Motor | | Pipe Size mm | Head in Meter | | | | | | | |
|---------|--------------------|-------|-----|--------------|------------------|------|------|------|------|------|------|-----|
| | | kW | HP | | 6 | 12 | 18 | 24 | 27 | 36 | 42 | 50 |
| | | | | | Discharge in LPH | | | | | | | |
| 3 | MINI MASTERPLUS I | 0.75 | 1.0 | 25 X 25 | 4250 | 3800 | 3350 | 2900 | 2650 | 1960 | 1510 | 900 |
| 4 | MINI MASTERPLUS II | 0.37 | 0.5 | 25 X 25 | 2700 | 2290 | 1800 | 1350 | 1140 | 500 | - | - |

| Sr. No. | Rating | Motor | | Pipe Size (mm) | Head in Meter | | | | | | | |
|---------|-------------|-------|-----|----------------|------------------|------|------|------|------|------|------|-----|
| | | kW | HP | | 6 | 12 | 18 | 24 | 27 | 36 | 42 | 50 |
| | | | | | Discharge in LPH | | | | | | | |
| 5 | MINI NEO I | 0.75 | 1 | 25 X 25 | 4250 | 3800 | 3350 | 2900 | 2650 | 1960 | 1510 | 900 |
| 6 | MINI NEO II | 0.37 | 0.5 | 25 X 25 | 2700 | 2290 | 1800 | 1350 | 1140 | 500 | - | - |

Note:

1. The motor ratings in HP are only indicative and for reference purpose
2. Performance figures given above are approximate and may differ on site conditions
3. Performance mentioned on nameplate may vary as we are always improving our products
4. * Models are with CED Coating.

Material of Construction:

| No. | Part | Material |
|-----|-----------------------|------------------------------|
| 1 | Impeller | Forged Brass |
| 2 | Adaptor | Cast Iron-IS210 Grade FG 200 |
| 3 | Volute | Cast Iron-IS210 Grade FG 200 |
| 4 | Motor Body | Aluminium PDC- ADC12 Grade |
| 5 | Shaft | Stainless Steel-SS410 |
| 6 | Volute/Adaptor Insert | Stainless Steel-SS304 |
| 7 | Stamping | CRNGO-M47 |
| 8 | End Shield | Aluminium PDC- ADC12 Grade |
| 9 | Fan | PPCP |
| 10 | Fan Cover | PPCP |

Pump Dimensional Details:

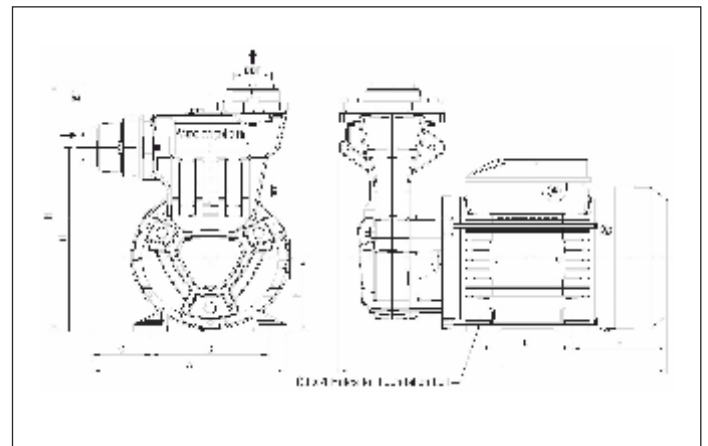
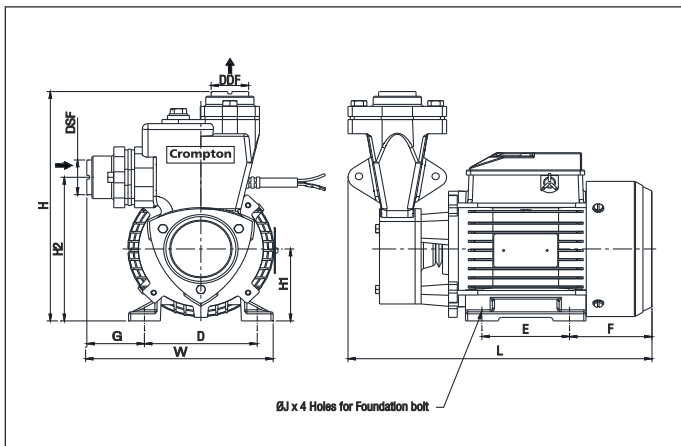

| Model Name | Pipe Size (mm) | All Dimensions are in mm | | | | | | | | | | | |
|--------------------|----------------|--------------------------|-----|-----|-----|-----|-----|-----|----|-----|----|---------|-----|
| | | H1 | DSF | DDF | L | W | H | D | G | E | F | J | H2 |
| MINI PACIFIC I | 25 X 25 | 80 | 25 | 25 | 335 | 194 | 293 | 125 | 55 | 100 | 99 | 14 X 10 | 220 |
| MINI PACIFIC II | 25 X 25 | 71 | 25 | 25 | 280 | 176 | 255 | 112 | 55 | 90 | 72 | 10 | 188 |
| MINI MASTERPLUS I | 25 X 25 | 80 | 25 | 25 | 326 | 194 | 280 | 125 | 55 | 100 | 99 | 14 X 10 | 211 |
| MINI MASTERPLUS II | 25 X 25 | 71 | 25 | 25 | 268 | 176 | 238 | 112 | 55 | 90 | 72 | 10 | 176 |
| MINI NEO I | 25 X 25 | 80 | 25 | 25 | 326 | 180 | 280 | 125 | 51 | 100 | 99 | 14 x 10 | 211 |
| MINI NEO II | 25 X 25 | 71 | 25 | 25 | 268 | 168 | 238 | 112 | 51 | 90 | 78 | 10 | 176 |

Mini Series Self Priming Regenerative Pumps - Standard & Economy Series

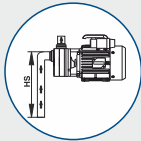

High Suction Capacity

Instant suction, Up to 8.0 meters suction lift



High Grade Electrical Stamping

Reduces electrical losses & improves pump efficiency



High Grade Brass Impeller

High quality forged brass impeller for longer life



Easy for Maintenance

Simple construction, easily replaceable wear & tear parts

Technical Specifications :

- Range: 0.125 HP to 2.0 HP (0.094 kW to 1.5 kW)
- Rated Voltage: 220V (1PH) & 415 (3PH)
- Voltage Range: 180V - 260V(1PH) & 350V-440V (3PH)
- Rated Frequency: 50Hz
- Pipe Size: 13mm X 13mm to 32mm X 25mm
- Max. head: Up to 60 Meters.
- Max. Discharge: Up to 4300LPH.
- Liquid: Clear & Cold Water

Application:

- Water supply to residential bungalows, garages, flats, dairies, hotels, laundries, club, hospitals etc
- Gardening
- Lawn sprinklers
- Ornamental fountains
- Water feeding in solar system
- Booster applications

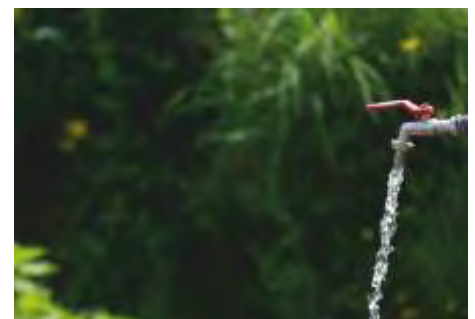
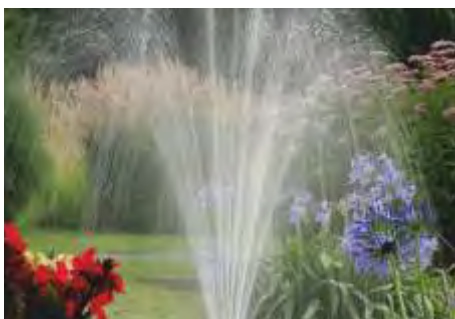

Performance Curve:

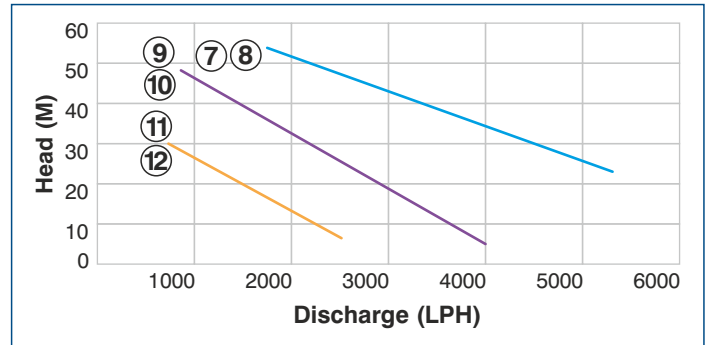
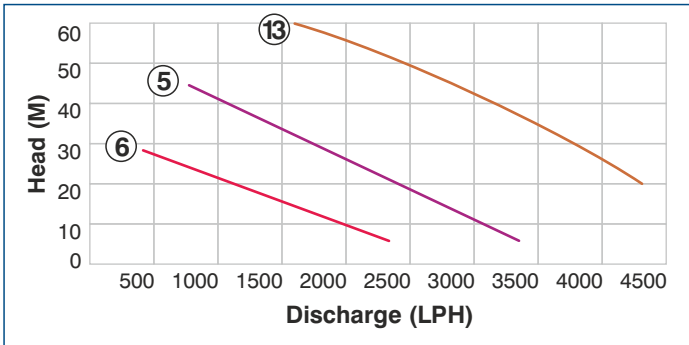
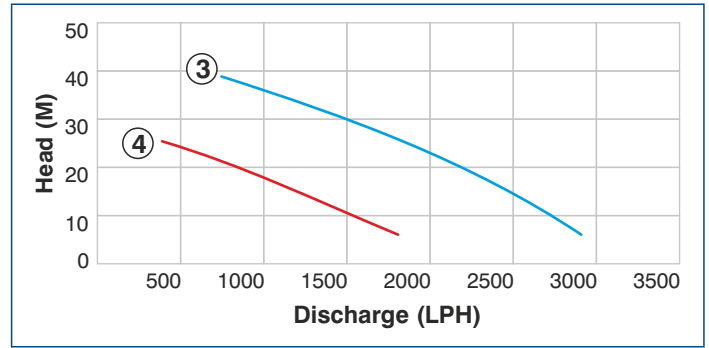
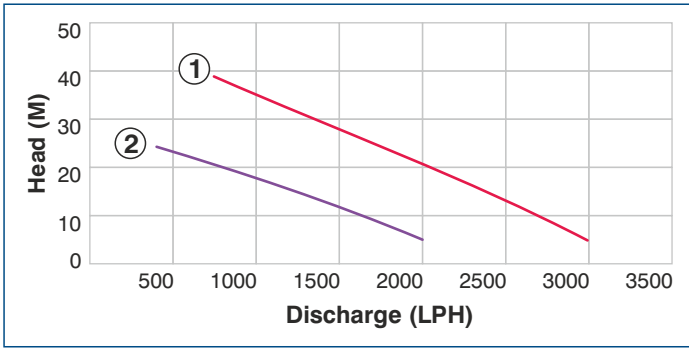

Performance Table:

| Sr. No. | Rating | Motor | | Pipe Size mm | Head in Meter | | | | | |
|---------|------------------|-------|-----|--------------|------------------|------|-----------|--------------|------|------------|
| | | | | | 6 | 15 | 24 | 30 | 39 | 48 |
| | | kW | HP | | Discharge in LPH | | | | | |
| 1 | MINI MARVEL I | 0.75 | 1.0 | 25 x 25 | 3000 | 2400 | 1800 | 1400 | 750 | - |
| 2 | MINI MARVEL II | 0.37 | 0.5 | 25 X 25 | 2000 | 1200 | 400 | - | - | - |
| 3 | MINI SAPPHIRE I | 0.75 | 1.0 | 25 X 25 | 2880 | 2480 | 1880 | 1500 | 750 | - |
| 4 | MINI SAPPHIRE II | 0.37 | 0.5 | 25 X 25 | 1830 | 1200 | 425 @ 25M | | - | - |
| 5 | MINI STAR I | 0.75 | 1.0 | 25 X 25 | 3350 | 2750 | 2150 | 1750 | 1150 | 750 @ 45 M |
| 6 | MINI STAR II | 0.37 | 0.5 | 25 X 25 | 2400 | 1590 | 800 | 400 @ 28.5 M | | - |

| Sr. No. | Rating | Motor | | Pipe Size mm | Head in Meter | | | | | | |
|---------|----------------------|-------|-----|--------------|------------------|------|------|------|------|------|------|
| | | | | | 6 | 15 | 24 | 30 | 39 | 48 | 54 |
| | | kW | HP | | Discharge in LPH | | | | | | |
| *7 | MINI XTRAA | 1.1 | 1.5 | 25 X 25 | - | - | 5200 | 4500 | 3500 | 2480 | 1800 |
| *8 | MINI XTRAA (3PH) | 1.1 | 1.5 | 25 X 25 | - | - | 5200 | 4500 | 3500 | 2480 | 1800 |
| *9 | MINI MASTER I | 0.75 | 1.0 | 25 X 25 | 4000 | 3340 | 2690 | 2250 | 1590 | 950 | - |
| *10 | MINI MASTER I (3PH) | 0.75 | 1.0 | 25 X 25 | 4000 | 3340 | 2690 | 2250 | 1590 | 950 | - |
| *11 | MINI MASTER II | 0.37 | 0.5 | 25 X 25 | 2600 | 1860 | 1100 | 600 | - | - | - |
| *12 | MINI MASTER II (3PH) | 0.37 | 0.5 | 25 X 25 | 2600 | 1860 | 1100 | 600 | - | - | - |

| Sr. No. | Rating | Motor | | Pipe Size mm | Head in Meter | | | | |
|---------|--------------|-------|-----|--------------|------------------|------|------|------|------|
| | | | | | 20 | 30 | 40 | 50 | 60 |
| | | kW | HP | | Discharge in LPH | | | | |
| *13 | MINI EVEREST | 1.5 | 2.0 | 32 X 25 | 4300 | 4100 | 3500 | 2650 | 1600 |

Performance Curve:

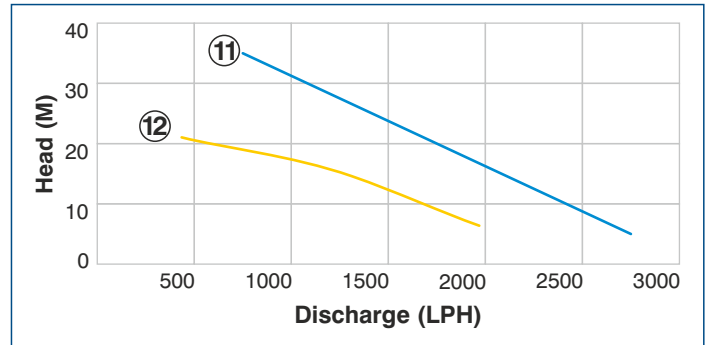
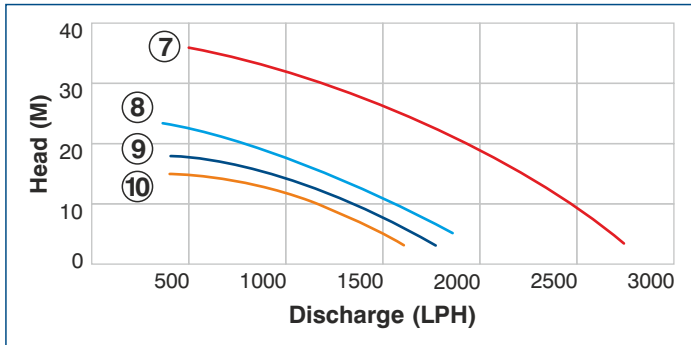
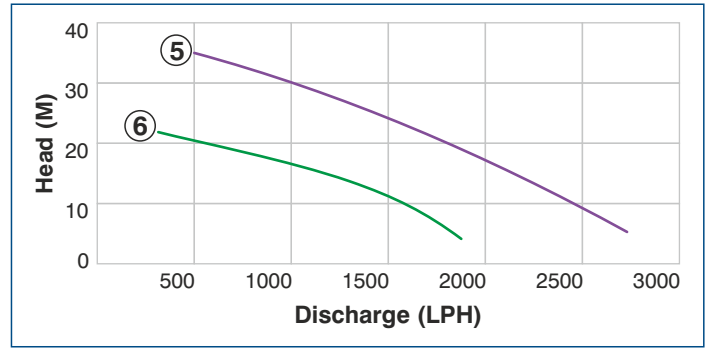
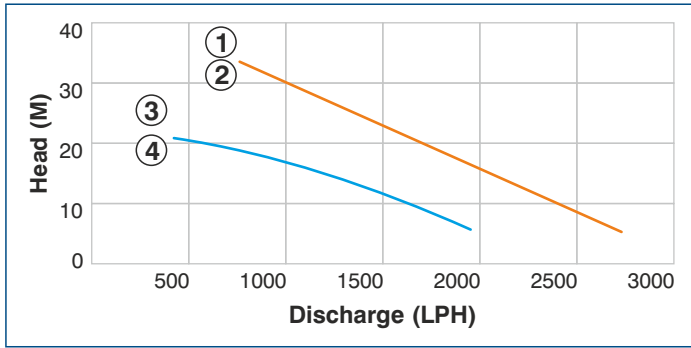

Performance Table:

| Sr. No. | Rating | Motor | | Pipe Size mm | Head in Meter | | | | | |
|---------|----------------|-------|-----|--------------|------------------|------|------------|------|------------|----|
| | | kW | HP | | 6 | 15 | 24 | 30 | 39 | 48 |
| | | | | | Discharge in LPH | | | | | |
| 1 | MINI CREST I | 0.75 | 1.0 | 25 X 25 | 2700 | 2100 | 1450 | 1050 | 750 @ 34 M | |
| 2 | MINI CHROME I | 0.75 | 1.0 | 25 X 25 | 2700 | 2100 | 1450 | 1050 | 750 @ 34 M | |
| 3 | MINI CREST II | 0.37 | 0.5 | 25 X 25 | 1950 | 1200 | 450 @ 21 M | | - | - |
| 4 | MINI CHROME II | 0.37 | 0.5 | 25 X 25 | 1950 | 1200 | 450 @ 21 M | | - | - |

| Sr. No. | Rating | Motor | | Pipe Size mm | Head in Meter | | | | | |
|---------|---------------|-------|-----|--------------|------------------|------|------------|------|------------|----|
| | | kW | HP | | 6 | 15 | 24 | 30 | 39 | 48 |
| | | | | | Discharge in LPH | | | | | |
| 5 | MINI CHAMP I | 0.75 | 1.0 | 25 X 25 | 2700 | 2100 | 1450 | 1050 | 500 @ 34 M | |
| 6 | MINI CHAMP II | 0.37 | 0.5 | 25 X 25 | 1850 | 1200 | 300 @ 21 M | | - | - |

| Sr. No. | Rating | Motor | | Pipe Size mm | Head in Meter | | | | | |
|---------|-----------------|-------|-----|--------------|------------------|------|------|------|------------|----|
| | | kW | HP | | 6 | 15 | 24 | 30 | 39 | 48 |
| | | | | | Discharge in LPH | | | | | |
| 7 | MINI SAMUDRA I | 0.75 | 1.0 | 25 X 25 | 2700 | 2280 | 1620 | 1200 | 500 @ 36 M | |
| 8 | MINI SAMUDRA II | 0.37 | 0.5 | 25 X 25 | 1830 | 1200 | 400 | - | - | - |

| Sr. No. | Rating | Motor | | Pipe Size mm | Head in Meter | | | | | |
|---------|------------------|-------|-------|--------------|------------------|------|------|-----|-----|---|
| | | kW | HP | | 3 | 6 | 12 | 15 | 18 | |
| | | | | | Discharge in LPH | | | | | |
| 9 | MINI SAMUDRA III | 0.18 | 0.25 | 20 X 20 | 1760 | 1600 | 1200 | 920 | 400 | - |
| 10 | MINI SAMUDRA IV | 0.094 | 0.125 | 13 X 13 | 1600 | 1440 | 970 | 400 | - | - |

| Sr. No. | Rating | Motor | | Pipe Size mm | Head in Meter | | | | | |
|---------|----------------|-------|-----|--------------|------------------|------|------------|------|------------|----|
| | | kW | HP | | 6 | 15 | 24 | 30 | 39 | 48 |
| | | | | | Discharge in LPH | | | | | |
| 11 | MINI STRONG I | 0.75 | 1.0 | 25 X 25 | 2700 | 2100 | 1500 | 1100 | 750 @ 34 M | |
| 12 | MINI STRONG II | 0.37 | 0.5 | 25 X 25 | 1950 | 1200 | 450 @ 21 M | | - | - |

Note :

1. The motor ratings in HP are only indicative and for reference purpose
2. Performance figures given above are approximate and may differ on site conditions

3 *18 months warranty is only for MINI MASTER, MINI EVEREST & MINI XTRAA SERIES

4. Performance mentioned on nameplate may vary as we are always improving our products

Pump Dimensional Details:

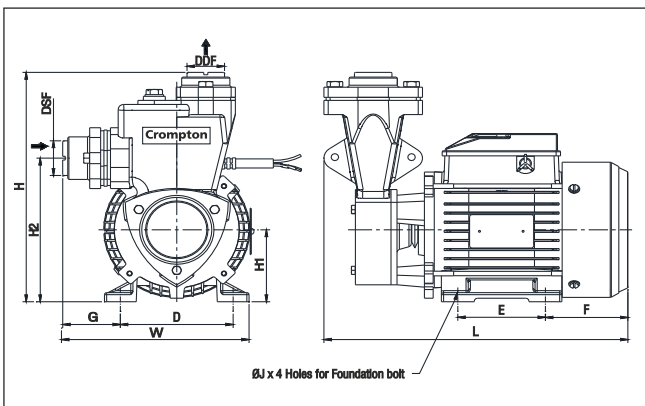

Material of Construction:

| No. | Part | Material |
|-----|--|------------------------------|
| 1 | Impeller | Forged Brass |
| 2 | Adaptor | Cast Iron-IS210 Grade FG 200 |
| 3 | Volute | Cast Iron-IS210 Grade FG 200 |
| 4 | Motor Body | Aluminium Extruded-HE9 Grade |
| 5 | Motor Body - Mini Master, Mini Marvel, Mini Xtraa Series | Aluminium PDC- ADC12 Grade |
| 6 | Motor Body - Mini Everest, Mini Strong Series | Cast Iron-IS210 Grade FG 200 |
| 7 | Shaft | Stainless Steel-SS410 |
| 8 | Stamping | CRNGO-M47 |
| 9 | End Shield | Aluminium PDC-ADC12 Grade |
| 10 | End Shield - Mini Everest | Cast Iron-IS210 Grade FG 200 |
| 11 | Fan | PPCP |
| 12 | Fan Cover | PPCP |

| Model Name | Pipe Size mm | All Dimensions are in mm | | | | | | | | | | | |
|----------------------|--------------|--------------------------|-----|-----|-----|-----|-----|-----|------|-----|------|---------|-----|
| | | H1 | DSF | DDF | L | W | H | D | G | E | F | J | H2 |
| MINI MASTER I | 25 X 25 | 80 | 25 | 25 | 345 | 185 | 245 | 125 | 43 | 100 | 99 | 14 X 10 | 165 |
| MINI MASTER I (3PH) | 25 X 25 | 80 | 25 | 25 | 345 | 185 | 245 | 125 | 43 | 100 | 99 | 14 X 10 | 165 |
| MINI EVEREST | 32 X 25 | 110 | 32 | 25 | 410 | 190 | 295 | 150 | 32 | 130 | 115 | 13.5 | 190 |
| MINI STAR I | 25 X 25 | 71 | 25 | 25 | 285 | 170 | 245 | 112 | 38 | 90 | 78 | 9 | 131 |
| MINI MARVEL I | 25 X 25 | 71 | 25 | 25 | 280 | 150 | 225 | 112 | 38 | 90 | 78 | 9 | 143 |
| MINI SAMUDRA I | 25 X 25 | 71 | 25 | 25 | 275 | 170 | 240 | 112 | 35 | 80 | 80 | 9 | 145 |
| MINI SAPPHIRE I | 25 X 25 | 71 | 25 | 25 | 265 | 165 | 230 | 110 | 42.5 | 80 | 70 | 9 | 140 |
| MINI XTRAA | 25 X 25 | 80 | 25 | 25 | 375 | 170 | 252 | 125 | 43 | 100 | 112 | 14 X 10 | 160 |
| MINI XTRAA (3PH) | 25 X 25 | 80 | 25 | 25 | 375 | 170 | 252 | 125 | 43 | 100 | 112 | 14 X 10 | 160 |
| MINI CHAMP I | 25 X 25 | 71 | 25 | 25 | 250 | 160 | 215 | 101 | 48.5 | 75 | 65 | 9 | 161 |
| MINI CHROME I | 25 X 25 | 71 | 25 | 25 | 260 | 160 | 215 | 110 | 42 | 80 | 75 | 9 | 158 |
| MINI CREST I | 25 X 25 | 71 | 25 | 25 | 270 | 170 | 218 | 112 | 35 | 80 | 80 | 9 | 160 |
| MINI STRONG I | 25 X 25 | 71 | 25 | 25 | 270 | 270 | 216 | 116 | 33 | 70 | 80 | 9 | 160 |
| MINI MASTER II | 25 X 25 | 71 | 25 | 25 | 285 | 150 | 232 | 112 | 35 | 90 | 72 | 10 | 137 |
| MINI MASTER II (3PH) | 25 X 25 | 71 | 25 | 25 | 285 | 150 | 232 | 112 | 35 | 90 | 72 | 10 | 137 |
| MINI STAR II | 25 X 25 | 71 | 25 | 25 | 271 | 150 | 215 | 112 | 38 | 66 | 80 | 9 | 133 |
| MINI MARVEL II | 25 X 25 | 63 | 25 | 25 | 260 | 140 | 207 | 100 | 20 | 80 | 68 | 10 X 8 | 125 |
| MINI SAMUDRA II | 25 X 25 | 71 | 25 | 25 | 247 | 147 | 210 | 112 | 12 | 60 | 82 | 9 | 154 |
| MINI SAMUDRA III | 20 X 20 | 63 | 20 | 20 | 230 | 140 | 185 | 92 | 37.5 | 62 | 69 | 9 | 135 |
| MINI SAMUDRA IV | 13 X 13 | 63 | 13 | 13 | 225 | 140 | 185 | 92 | 37.5 | 58 | 68 | 9 | 135 |
| MINI SAPPHIRE II | 25 X 25 | 71 | 25 | 25 | 235 | 150 | 205 | 110 | 27.5 | 60 | 75 | 9 | 150 |
| MINI CHAMP II | 25 X 25 | 63 | 25 | 25 | 250 | 145 | 205 | 101 | 33.5 | 75 | 73 | 9 | 148 |
| MINI CHROME II | 25 X 25 | 71 | 25 | 25 | 240 | 156 | 205 | 110 | 37 | 60 | 72 | 9 | 148 |
| MINI CREST II | 25 X 25 | 71 | 25 | 25 | 247 | 147 | 210 | 112 | 12 | 60 | 82 | 9 | 154 |
| MINI STRONG II | 25 X 25 | 63 | 25 | 25 | 235 | 147 | 202 | 96 | 31.5 | 56 | 70.5 | 9 | 146 |

Aquagold Series Self Priming Regenerative Pumps



High Suction Capacity

Instant suction, Up to 8.0 meters suction lift



High Grade Electrical Stamping

Reduces electrical losses & improves pump efficiency



High Grade Stainless Steel parts

SS304 suction & delivery casing for stuck free & rust free operation



Easy for Maintenance

Simple construction, easily replaceable wear & tear parts



High Grade Brass Impeller

High quality forged brass impeller for longer life

Technical Specifications:

- Range: 0.5 HP to 1.5 HP (0.37 kW to 1.1 kW)
- Rated Voltage: 220V
- Voltage Range: 180V - 260V (1PH)
- Rated Frequency: 50Hz
- Pipe Size: 15mm X 15mm & 25mm X 25mm
- Max. head: Up to 45 Meters.
- Max. Discharge: Up to 3360LPH.
- Liquid: Clear & Cold Water

Application:

- Water supply to residential bungalows, garages, flats, dairies, hotels, laundries, club, hospitals etc
- Gardening
- Lawn sprinklers
- Ornamental fountains
- Water feeding in solar system
- Booster applications



Performance Curve:

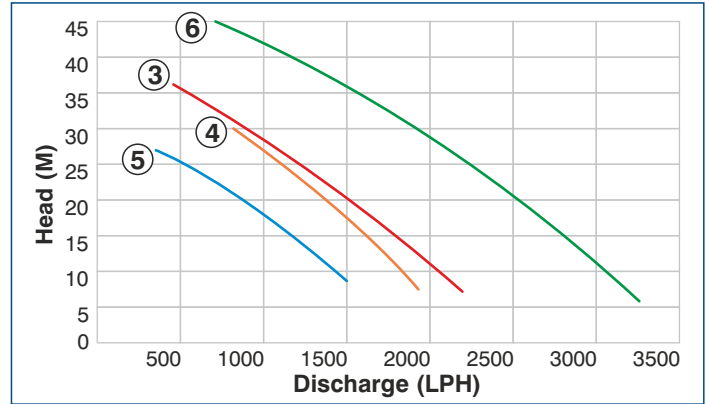
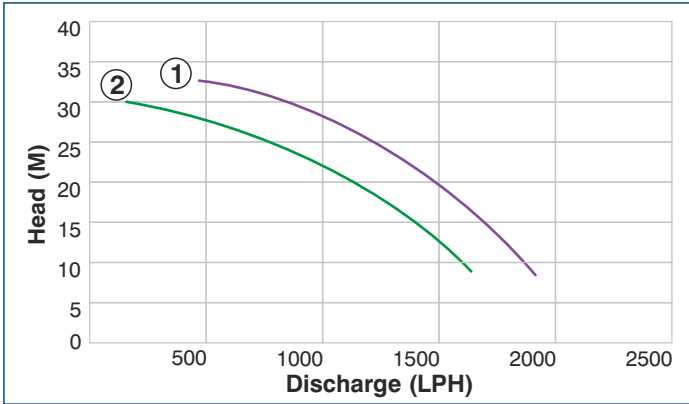

Performance Table:

| Sr. No. | Rating | Motor | | Pipe Size mm | Head in Meter | | | | | | | | |
|---------|-----------------|-------|-----|--------------|---------------|------|------|------|------|-----|-----|----|---|
| | | kW | HP | | 6 | 12 | 18 | 21 | 27 | 30 | 33 | 36 | |
| 1 | AQUAGOLD 100-33 | 0.75 | 1.0 | 25 X 25 | 1950 | 1750 | 1500 | 1360 | 1045 | 860 | 500 | - | - |
| 2 | AQUAGOLD 50-30 | 0.37 | 0.5 | 15 X 15 | 1700 | 1500 | 1250 | 1080 | 650 | 150 | - | - | - |

| Sr. No. | Rating | Motor | | Pipe Size mm | Head in Meter | | | | | | | | |
|---------|--------------|-------|------|--------------|---------------|------|------|------|------|-----|-----|-----|---|
| | | kW | HP | | 6 | 12 | 18 | 21 | 27 | 30 | 33 | 36 | |
| 3 | AQUAGOLD 100 | 0.75 | 1.0 | 25 X 25 | 2150 | 1850 | 1550 | 1400 | 1050 | 850 | 650 | 400 | - |
| 4 | AQUAGOLD 75 | 0.55 | 0.75 | 25 X 25 | 1900 | 1650 | 1400 | 1250 | 950 | 800 | - | - | - |
| 5 | AQUAGOLD 50 | 0.37 | 0.5 | 15 X 15 | 1500 | 1200 | 950 | 800 | 350 | - | - | - | - |

| Sr. No. | Rating | Motor | | Pipe Size mm | Head in Meter | | | | | | | | |
|---------|--------------|-------|-----|--------------|---------------|------|------|------|------|------|------|-----|---|
| | | kW | HP | | 6 | 12 | 18 | 27 | 33 | 36 | 42 | 45 | |
| 6 | AQUAGOLD 150 | 1.1 | 1.5 | 25 X 25 | 3360 | 3010 | 2745 | 2320 | 1985 | 1775 | 1225 | 720 | - |

Note :

- The motor ratings in HP are only indicative and for reference purpose
- Performance figures given above are approximate and may differ on site conditions
- Performance mentioned on nameplate may vary as we are always improving our products

Pump Dimensional Details:

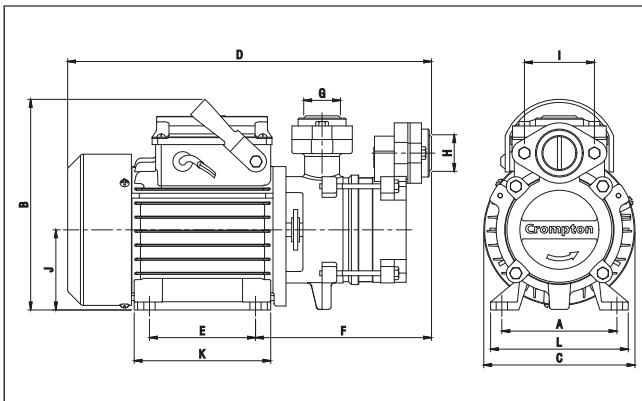

Material of Construction:

| No. | Part | Material |
|-----|--------------------------|------------------------------|
| 1 | Impeller | Brass |
| 2 | Suction/delivery chamber | Cast Iron-IS210 Grade FG 200 |
| 3 | Suction/delivery casing | Stainless Steel-SS304 |
| 4 | Shaft | Stainless Steel-SS410 |
| 5 | Motor body | Aluminium Extruded-HE9 Grade |
| 6 | Stamping | CRNGO-M47 |
| 7 | End cover | Aluminium PDC-ADC12 Grade |
| 8 | End cover - Aquagold 150 | Cast Iron-IS210 Grade FG 200 |
| 9 | Fan | PPCP |
| 10 | Fan cover | PPCP |
| 11 | Fan cover - Aquagold 150 | MS Sheet Metal |

| Model Name | Pipe Size mm | All Dimensions are in mm | | | | | | | | | | | |
|-----------------|--------------|--------------------------|-----|-----|-----|----|-----|----|----|----|----|-----|-----|
| | | A | B | C | D | E | F | G | H | I | J | K | L |
| AQUAGOLD 50 | 15 X 15 | 102 | 190 | 134 | 315 | 75 | 159 | 13 | 13 | 55 | 71 | 102 | 122 |
| AQUAGOLD 75 | 25 X 25 | 102 | 190 | 134 | 315 | 75 | 159 | 25 | 25 | 55 | 71 | 102 | 122 |
| AQUAGOLD 100 | 25 X 25 | 102 | 190 | 134 | 330 | 94 | 159 | 25 | 25 | 62 | 71 | 121 | 122 |
| AQUAGOLD 50-30 | 15 X 15 | 102 | 180 | 125 | 308 | 75 | 110 | 15 | 15 | 55 | 63 | 102 | 122 |
| AQUAGOLD 100-33 | 25 X 25 | 102 | 190 | 135 | 315 | 75 | 120 | 25 | 25 | 62 | 71 | 102 | 122 |
| AQUAGOLD 150 | 25 X 25 | 117 | 200 | 160 | 400 | 99 | 200 | 25 | 25 | 68 | 78 | 127 | 148 |

Flomax Series Self Priming Regenerative Pumps

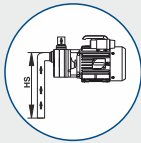

High Suction Capacity

Instant suction, Up to 8.0 meters suction lift



High Grade Electrical Stamping

Reduces electrical losses & improves pump efficiency



High Grade Brass Impeller

High quality forged brass impeller for longer life



Easy for Maintenance

Simple construction, easily replaceable wear & tear parts

Technical Specifications:

- 0.5 HP & 1.0 HP (0.37kW & 0.75kW)
- Rated voltage: 220V
- Voltage range: 180V-260V (1PH)
- Rated Frequency: 50Hz
- Pipe size: 25mm X 25mm
- Max. head: up to 54 meters
- Max. discharge: up to 3000 LPH

Application:

- Water supply to residential bungalows, garages, flats, dairies, hotels, laundries, club, hospitals etc
- Gardening
- Lawn sprinklers
- Ornamental fountains
- Water feeding in solar system
- Booster applications



Performance Curve:

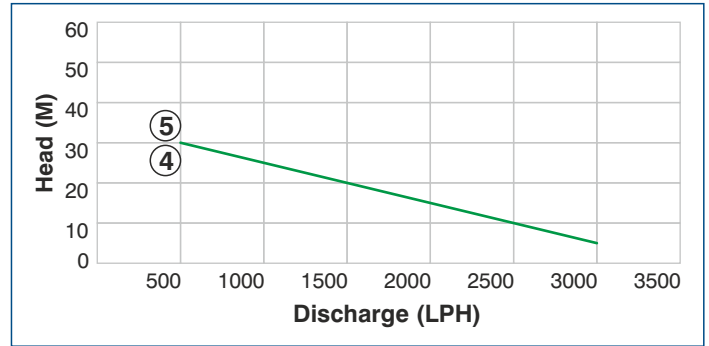
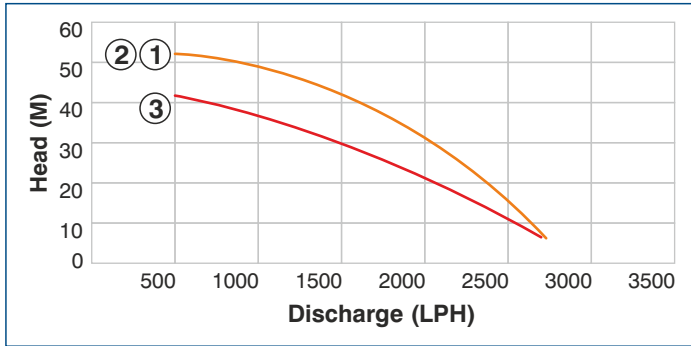

Performance Table:

| Sr. No. | Rating | Motor | | Pipe Size mm | Head in Meter | | | | | | | | | |
|---------|---------------|-------|-----|--------------|------------------|------|------|------|------|------|------|------|-----|--|
| | | kW | HP | | 6 | 12 | 18 | 24 | 30 | 36 | 42 | 48 | 54 | |
| | | | | | Discharge in LPH | | | | | | | | | |
| 1 | FLOMAX I | 0.75 | 1.0 | 25 X 25 | 2800 | 2650 | 2500 | 2300 | 2050 | 1800 | 1400 | 1000 | 500 | |
| 2 | FLOMAXCI I | 0.75 | 1.0 | 25 X 25 | 2800 | 2650 | 2500 | 2300 | 2050 | 1800 | 1400 | 1000 | 500 | |
| 3 | MINI FLOMAX I | 0.75 | 1.0 | 25 X 25 | 2700 | 2490 | 2200 | 1860 | 1480 | 1015 | 500 | - | - | |

| Sr. No. | Rating | Motor | | Pipe Size mm | Head in Meter | | | | | | | | | |
|---------|-------------|-------|-----|--------------|------------------|------|------|------|------|------|------|-----|-----|--|
| | | kW | HP | | 6 | 9 | 12 | 15 | 18 | 21 | 24 | 27 | 30 | |
| | | | | | Discharge in LPH | | | | | | | | | |
| 4 | FLOMAX II | 0.37 | 0.5 | 25 X 25 | 3000 | 2675 | 2350 | 2050 | 1750 | 1425 | 1100 | 800 | 500 | |
| 5 | FLOMAXCI II | 0.37 | 0.5 | 25 X 25 | 3000 | 2675 | 2350 | 2050 | 1750 | 1425 | 1100 | 800 | 500 | |

Note:

- The motor ratings in HP are only indicative and for reference purpose
- Performance figures given above are approximate and may differ on site conditions
- Performance mentioned on nameplate may vary as we are always improving our products

Pump Dimensional Details:

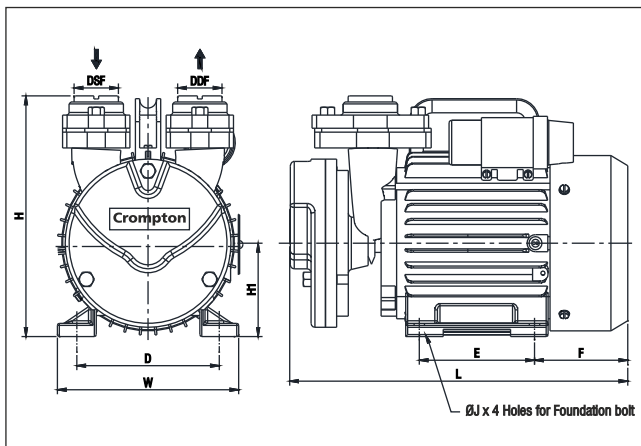

Material of Construction:

| No. | Part | Material |
|-----|------------------------------|------------------------------|
| 1 | Impeller | Forged Brass |
| 2 | Adaptor | Cast Iron-IS210 Grade FG200 |
| 3 | Volute Casing | Cast Iron-IS210 Grade FG200 |
| 4 | Motor body | Aluminium Extruded-HE9 Grade |
| 5 | Motor Body- Flomax CI Series | Cast Iron-IS210 Grade FG200 |
| 6 | Shaft | Stainless Steel- SS410 |
| 7 | Stamping | CRNGO-M47 |
| 8 | End Shield | Aluminium PDC-ADC12 Grade |
| 9 | Fan | PPCP |
| 10 | Fan Cover | PPCP |

| Model Name | Pipe Size (mm) | All Dimensions are in mm | | | | | | | | | |
|---------------|----------------|--------------------------|-----|-----|-----|-----|-----|-------|-----|----|-----|
| | | H1 | DSF | DDF | L | W | H | D | E | F | J |
| FLOMAX I | 25 X 25 | 80 | 25 | 25 | 310 | 160 | 220 | 125 | 105 | 85 | f10 |
| FLOMAXCI I | | | | | | | | | | | |
| MINI FLOMAX I | 25 X 25 | 85 | 25 | 25 | 300 | 114 | 220 | 118.5 | 90 | 95 | 10 |
| FLOMAX II | 25 X 25 | 71 | 25 | 25 | 260 | 150 | 190 | 112 | 90 | 78 | f9 |
| FLOMAXCI II | | | | | | | | | | | |

DMB / CMB Series Self Priming Regenerative Pumps

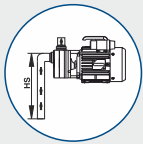

High Suction Capacity

Instant suction, Up to 8.0 meters suction lift



High Grade Electrical Stamping

Reduces electrical losses & improves pump efficiency



Wide Voltage Application

Works effectively in wide voltage range from 180V - 260V for 1PH & 350V - 440V for 3PH



Easy for Maintenance

Simple construction, easily replaceable wear & tear parts

Technical Specifications:

- 0.5 HP to 3.0 HP (0.37kW to 2.2kW)
- Rated voltage: 220V for 1PH & 415V for 3PH
- Voltage range: 180V-260V for 1PH & 350V-440V for 3PH
- Rated Frequency: 50Hz
- Pipe size: 25mm X 25mm & 40mm X 40mm
- Max. head: up to 55 meters
- Max. discharge: up to 11700 LPH
- Speed: 1450 RPM

Application:

- Water supply to residential bungalows, garages, flats, dairies, hotels, laundries, club, hospitals etc
- Gardening
- Lawn sprinklers
- Ornamental fountains
- Water feeding in solar system
- Booster applications



Performance Curve:

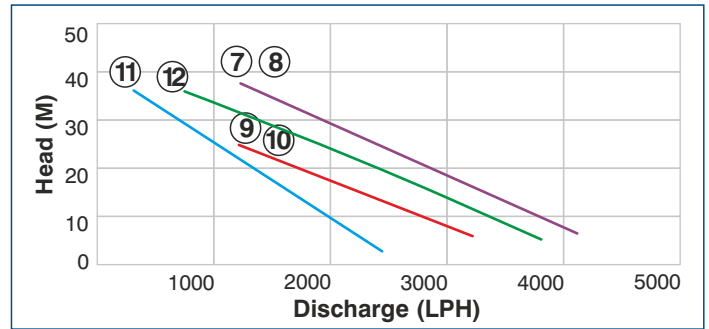
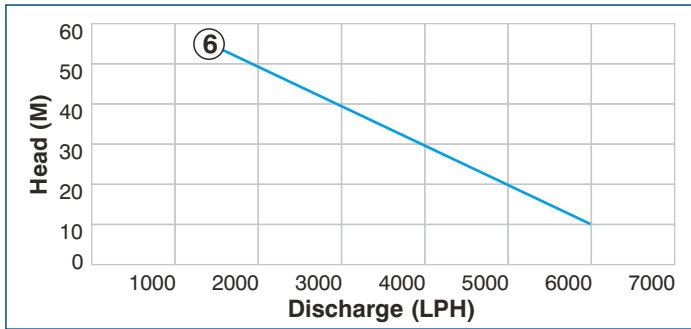
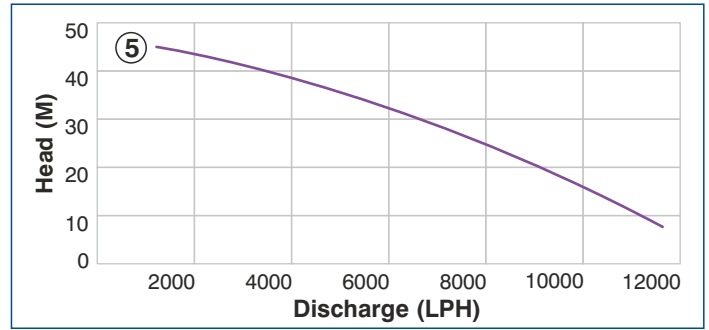
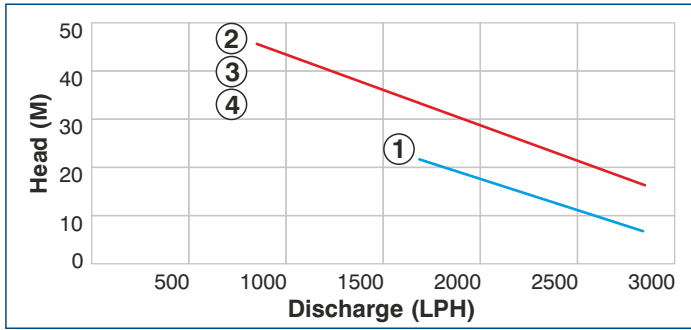

Performance Table:

| Sr. No. | Rating | Motor | | Pipe Size mm | Head in Meter | | | | | | | |
|---------|---------------|-------|-----|--------------|------------------|-------|------|------|------|------|------|-----|
| | | kW | HP | | 6 | 9 | 18 | 21 | 27 | 30 | 36 | 45 |
| | | | | | Discharge in LPH | | | | | | | |
| 1 | DMB05DG | 0.37 | 0.5 | 25 X 25 | 2860 | 2650 | 1940 | 1650 | - | - | - | - |
| 2 | DMB10DCSL | 0.75 | 1.0 | 25 X 25 | - | - | 2800 | 2540 | 2080 | 1860 | 1440 | 880 |
| 3 | DMB10ACSL | | | | | | | | | | | |
| \$4 | DMB10DGL(3PH) | 2.2 | 3.0 | 40 X 40 | - | 11700 | 9600 | 8800 | 7200 | 6500 | 4900 | 960 |
| \$5 | DMB30 | | | | | | | | | | | |

| Sr. No. | Rating | Motor | | Pipe Size mm | Head in Meter | | | | | |
|---------|--------|-------|-----|--------------|------------------|------|------|------|------|------|
| | | kW | HP | | 10 | 20 | 30 | 40 | 50 | 55 |
| | | | | | Discharge in LPH | | | | | |
| *6 | DMTJ24 | 1.5 | 2.0 | 40 X 40 | 6000 | 5000 | 4000 | 3000 | 1900 | 1500 |

| Sr. No. | Rating | Motor | | Pipe Size mm | Head in Meter | | | | | | | |
|---------|---------|-------|-----|--------------|------------------|------|------|------|------|------|------|------|
| | | kW | HP | | 6 | 12 | 18 | 21 | 24 | 27 | 33 | 39 |
| | | | | | Discharge in LPH | | | | | | | |
| 7 | CMB10N | 0.75 | 1.0 | 25 X 25 | 4080 | 3660 | 3060 | 2760 | 2520 | 2280 | 1680 | 1200 |
| 8 | CMB10NV | | | | | | | | | | | |
| 9 | CMB05N | 0.37 | 0.5 | 25 X 25 | 3240 | 2610 | 1950 | 1650 | 1320 | - | - | - |
| 10 | CMB05NV | | | | | | | | | | | |

| Sr. No. | Rating | Motor | | Pipe Size mm | Head in Meter | | | | | | | |
|---------|----------|-------|-----|--------------|------------------|------|------|------|------|-----|-----|-----|
| | | kW | HP | | 5 | 10 | 15 | 20 | 25 | 30 | 35 | 40 |
| | | | | | Discharge in LPH | | | | | | | |
| #11 | CMB052SV | 0.37 | 0.5 | 25 X 25 | 2470 | 2000 | 1750 | 1500 | 1230 | 950 | 700 | 400 |

| Sr. No. | Rating | Motor | | Pipe Size mm | Head in Meter | | | | | |
|---------|---------|-------|-----|--------------|------------------|------|------|------|------|-----|
| | | kW | HP | | 5 | 12 | 18 | 24 | 30 | 36 |
| | | | | | Discharge in LPH | | | | | |
| 12 | CMS10NV | 0.75 | 1.0 | 25 X 25 | 3800 | 3220 | 2600 | 2010 | 1400 | 750 |

Note:

- The motor ratings in HP are only indicative and for reference purpose
- Performance figures given above are approximate and may differ on site conditions

- Performance mentioned on nameplate may vary as we are always improving our products
- Model is with two stages
- #Model is with 2880 RPM
- \$ Model are in 3PH

Material of Construction:

| Sr. No. | Part | Material |
|---------|-------------------------------|---------------------------------|
| 1 | Impeller - CMB & DMTJ | Brass |
| 2 | Impeller - DMB | Stainless Steel - SS410 |
| 3 | Suction / Delivery Chamber | Cast Iron - IS 210 Grade FG 200 |
| 4 | Suction / Delivery Casing | Cast Iron - IS210 Grade FG 200 |
| 5 | Motor Body - DMB10D | MS Sheet Metal |
| 6 | Motor Body - DMB10A | Aluminium PDC-ADC12 Grade |
| 7 | Motor Body - CMB & DMTJ | Cast Iron - IS 210 Grade FG 200 |
| 8 | Shaft | Stainless Steel - SS410 |
| 9 | Stamping - DMB10D | CRNGO - M45 |
| 10 | Stamping - DMB10A, CMB & DMTJ | CRNGO - M47 |
| 11 | End Shield | Cast Iron - IS 210 Grade FG 200 |
| 12 | Fan | PPCP |
| 13 | Fan Cover - DMB, DMTJ & CMBNV | MS Sheet Metal |
| 14 | Fan Cover - CMBN | Cast Iron - IS210 Grade FG 200 |

Pump Dimensional Details:

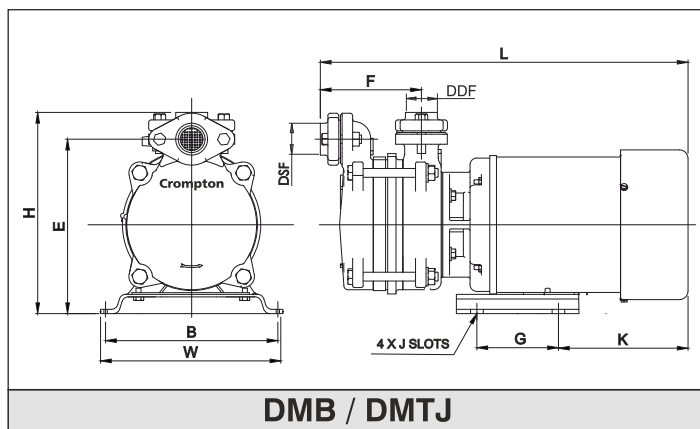

DMB / DMTJ

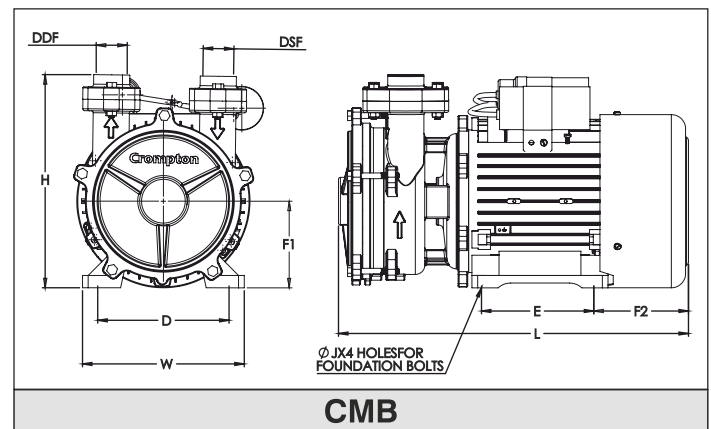

CMB

| Model Name | All Dimensions are in mm | | | | | | | | | | |
|----------------|--------------------------|-----|-----|-----|-----|---------|-------|------|-----|------|-----|
| | DSF | DDF | L | W | H | J | B | G | E | F | K |
| DMB05DG | 25 | 25 | 390 | 215 | 245 | 15 | 195 | N.A. | 210 | 120 | 110 |
| DMB10DCSL | 25 | 25 | 430 | 185 | 240 | 15 X 10 | 157 | 98 | 200 | 120 | 155 |
| DMB10DGL (3PH) | 25 | 25 | 440 | 185 | 240 | 15 X 10 | 157 | 98 | 200 | 120 | 165 |
| DMB10ACSL | 25 | 25 | 455 | 218 | 240 | Ø14 | 197 | N.A. | 200 | 120 | 163 |
| DMB30D | 40 | 40 | 539 | 200 | 255 | Ø12 | 164.5 | 139 | 212 | 181 | 122 |
| DMTJ24 | 40 | 40 | 565 | 255 | 245 | Ø14 | 185 | 140 | 225 | N.A. | 125 |

| Model Name | All Dimensions are in mm | | | | | | | | | | |
|------------|--------------------------|--------|--------|-----|-----|-----|-----|-----|-----|----|--|
| | F1 | DSF | DDF | L | W | H | D | E | F2 | J | |
| CMB05N | 103 | 25 | 25 | 355 | 225 | 224 | 160 | 75 | 98 | 10 | |
| CMB10N | 103 | 25 | 25 | 392 | 225 | 231 | 160 | 110 | 97 | 10 | |
| CMB05NV | 89 | 25 | 25 | 328 | 192 | 208 | 130 | 90 | 84 | 10 | |
| CMB10NV | 91 | 25 | 25 | 358 | 207 | 221 | 140 | 100 | 99 | 10 | |
| CMB052SV | 85 | 25 | 25 | 288 | 188 | 195 | 125 | 80 | 78 | 10 | |
| CMS10NV | 94 | 1" BSP | 1" BSP | 357 | 170 | 235 | 149 | 69 | 128 | 11 | |

SWJ / TWJ Series Self Priming Shallow Well Jet Pumps

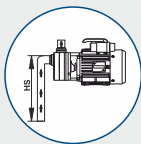

High Suction Capacity

Instant suction, Up to 8.0 meters suction lift



High Grade Electrical Stamping

Reduces electrical losses and improves pump efficiency



Wide Voltage Application

Work effectively in wide voltage range from 180V - 260V



Easy for Maintenance

Simple construction, easily replaceable wear and tear parts

Technical Specifications:

- Range: 0.5 HP and 1.0 HP (0.37 kW & 0.75 kW)
- Rated voltage: 220V
- Voltage range: 180V-260V
- Rated Frequency: 50Hz
- Pipe size: 25mm X 25mm
- Max. Head: Upto 44 meter
- Max. Discharge: Upto 60 LPM

Application:

- Water supply to residential bungalows, garages, flats, dairies, hotels, laundries, club, hospitals etc
- Gardening
- Lawn sprinklers
- Ornamental fountains
- Water feeding in solar system
- Booster applications



Performance Curve:

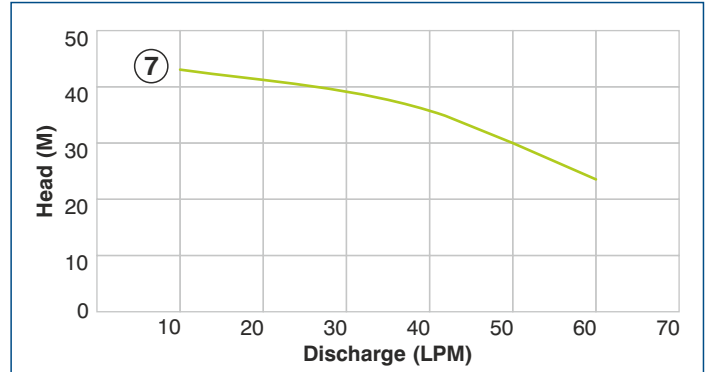
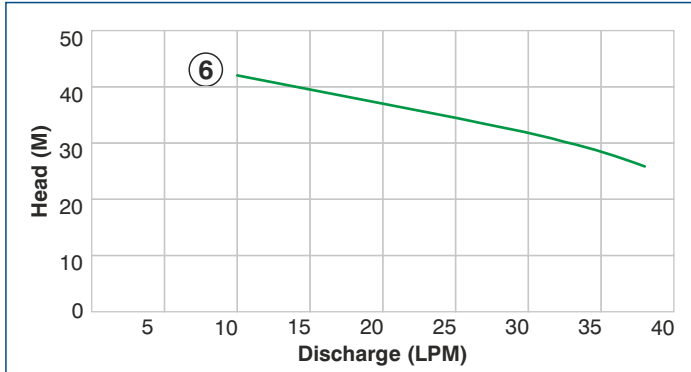
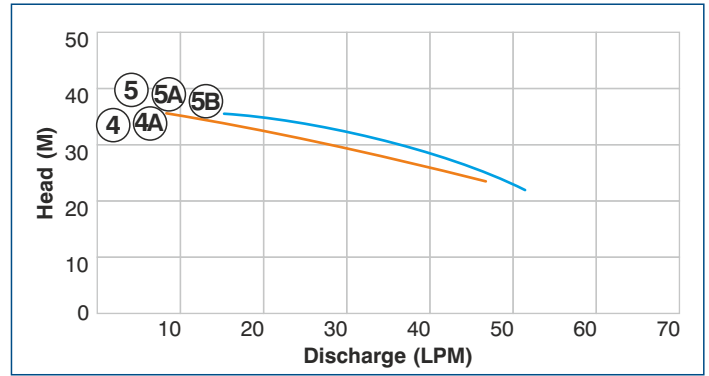
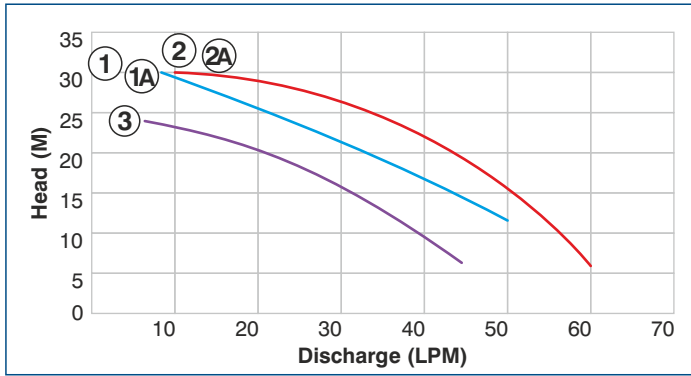

Performance Table:

| Sr. No. | Rating | Motor | | Pipe Size mm | Head in Meter | | | | | | | |
|---------|--------------|-------|-----|--------------|------------------|----|----|----|----|----|----|----|
| | | | | | 6 | 9 | 12 | 21 | 24 | 27 | 30 | 36 |
| | | kW | HP | | Discharge in LPM | | | | | | | |
| 1 | SWJ50A-30 | 0.37 | 0.5 | 25 X 25 | - | - | 50 | 33 | 24 | 16 | 9 | - |
| 1A | SWJ50Y-30 | 0.37 | 0.5 | 25 X 25 | - | - | 50 | 33 | 24 | 16 | 9 | - |
| 2 | SWJ0.5A-30 | 0.37 | 0.5 | 25 X 25 | 60 | 58 | 56 | 41 | 32 | 22 | 10 | - |
| 2A | SWJ0.5SSA-30 | 0.37 | 0.5 | 25 X 25 | 60 | 58 | 56 | 41 | 32 | 22 | 10 | - |
| 3 | SWJ05MINI | 0.37 | 0.5 | 25 X 25 | 44 | 39 | 33 | 12 | 7 | - | - | - |
| 4 | SWJ100A-36 | 0.75 | 1.0 | 25 X 25 | - | - | - | - | 46 | 36 | 27 | 9 |
| 4A | SWJ100Y-36 | 0.75 | 1.0 | 25 X 25 | - | - | - | - | 46 | 36 | 27 | 9 |
| 5 | SWJ1 | 0.75 | 1.0 | 25 X 25 | - | - | - | 51 | 50 | 46 | 36 | 15 |
| 5A | SWJ1A-36 | 0.75 | 1.0 | 25 X 25 | - | - | - | 51 | 50 | 46 | 36 | 15 |
| 5B | SWJ1SSA-36 | 0.75 | 1.0 | 25 X 25 | - | - | - | 51 | 50 | 46 | 36 | 15 |

| Sr. No. | Rating | Motor | | Pipe Size mm | Head in Meter | | | | |
|---------|------------|-------|-----|--------------|------------------|----|----|----|----|
| | | | | | 26 | 30 | 34 | 38 | 42 |
| | | kW | HP | | Discharge in LPM | | | | |
| 6 | SWJ150A-42 | 1.1 | 1.5 | 25 X 25 | 38 | 33 | 26 | 18 | 10 |

| Sr. No. | Rating | Motor | | Pipe Size mm | No. Of Stages | Head in Meter | | | | | | |
|---------|--------|-------|-----|--------------|---------------|------------------|----|----|----|----|----|----|
| | | | | | | 24 | 28 | 30 | 32 | 34 | 36 | 44 |
| | | kW | HP | | | Discharge in LPM | | | | | | |
| 7 | TWJ1SS | 0.75 | 1.0 | 25 X 25 | 2 | 60 | 54 | 50 | 46 | 42 | 36 | 10 |

Note :

1. The motor ratings in HP are only indicative and for reference purpose
2. Performance figures given above are approximate and may differ on site conditions

3. Performance mentioned on nameplate may vary as we are always improving our products

Material of Construction:

| No. | Part | Material |
|-----|--------------------|-----------------------------|
| 1 | Fan Cowl(Cover) | PPCP/Mild Steel |
| 2 | End Cover(NDE) | Cast Iron-Grade FG 200 |
| 3 | Adaptor(DE) | Cast Iron-Grade FG 200 |
| 4 | Impeller | Noryl/Stainless Steel-SS410 |
| 5 | Diffuser | Noryl |
| 6 | Motor body | Aluminium (LM2) |
| 7 | Shaft | Stainless Steel-SS410 |
| 8 | Nozzle and Venturi | Noryl |
| 9 | Stamping | CRNGO-M47 |
| 10 | Fan | PPCP |

Pump Dimensional Details:

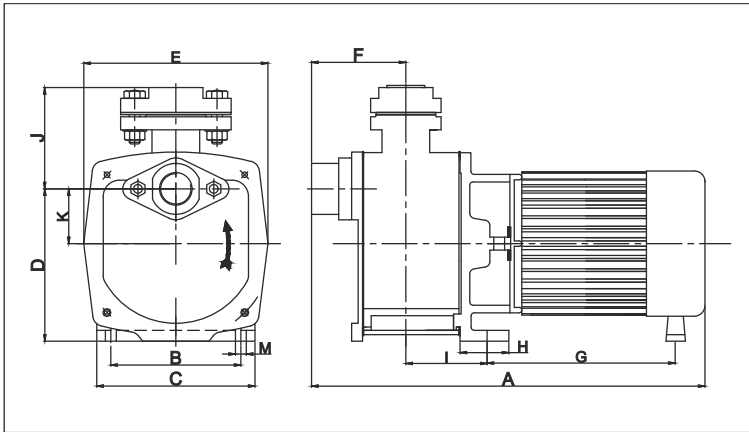

| Model Name | All Dimensions are in mm | | | | | | | | | | | |
|--------------|--------------------------|-----|-----|-----|-----|-----|-----|----|----|----|----|----|
| | A | B | C | D | E | F | G | H | I | J | K | M |
| SWJ50A-30 | 375 | 121 | 160 | 93 | 172 | 90 | 155 | 39 | 80 | 85 | 45 | 16 |
| SWJ50Y-30 | 320 | 120 | 155 | 80 | 175 | 100 | 155 | 40 | 70 | 75 | 50 | 9 |
| SWJ0.5A-30 | 375 | 122 | 160 | 95 | 170 | 80 | 165 | 40 | 65 | 80 | 50 | 15 |
| SWJ0.5SSA-30 | 375 | 125 | 160 | 92 | 175 | 95 | 150 | 40 | 80 | 65 | 50 | 16 |
| SWJ0.5MINI | 355 | 110 | 145 | 88 | 140 | 90 | 140 | 35 | 65 | 65 | 50 | 15 |
| SWJ100A-36 | 400 | 125 | 160 | 93 | 174 | 90 | 185 | 40 | 80 | 85 | 50 | 16 |
| SWJ100Y-36 | 365 | 120 | 155 | 80 | 175 | 100 | 195 | 40 | 70 | 75 | 50 | 9 |
| SWJ1 | 455 | 115 | 160 | 100 | 174 | 90 | 185 | 40 | 80 | 80 | 50 | 15 |
| SWJ1A-36 | 410 | 116 | 160 | 95 | 174 | 85 | 190 | 40 | 75 | 80 | 50 | 15 |
| SWJ1SSA-36 | 410 | 116 | 160 | 95 | 174 | 85 | 190 | 40 | 75 | 80 | 50 | 15 |
| SWJ150A-42 | 470 | 115 | 160 | 150 | 174 | 90 | 200 | 40 | 80 | 80 | 50 | 15 |
| TWJ1SS | 490 | 110 | 165 | 100 | 170 | - | - | - | - | - | - | - |

Centrifugal Deep Well Jet Pumps



High Grade Electrical Stamping

Reduces electrical losses and improves pump efficiency



High Grade Stainless Steel

Pure stainless steel construction resists corrosion and withstands tough operating conditions



Reliable Mechanical Seal

High quality and long life mechanical seal



Easy for Maintenance

Simple construction, easily replaceable wear and tear parts

Technical Specifications:

- Range: 0.5 HP to 2.0HP (0.37 kW to 1.5 kW)
- Rated voltage: 220V for 1 PH
- Voltage range: 180V-240V
- Rated Frequency: 50Hz
- Borewell size: Suitable for 80 mm and above
- Suction lift: Upto 90 meter DLWL (Jet Setting Depth)
- Capacity: Upto 2800 LPH
- Type: Twin and Packer type design
- Installation: Vertical or horizontal
- Liquid: Clear water

Application:

- Lawn sprinklers
- Residential/commercial buildings
- Water supply systems
- Lifting water from well, borewell to houses



Performance Curve:

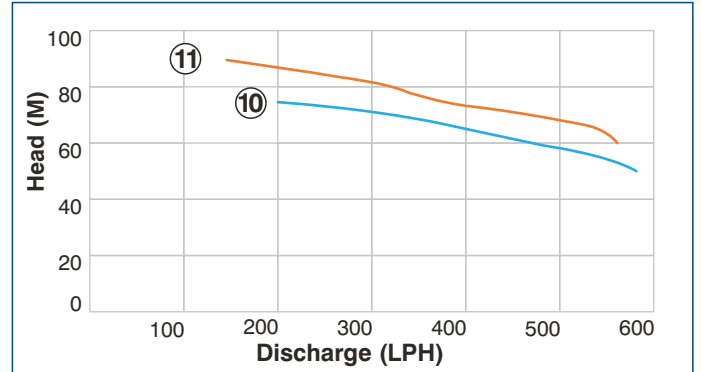
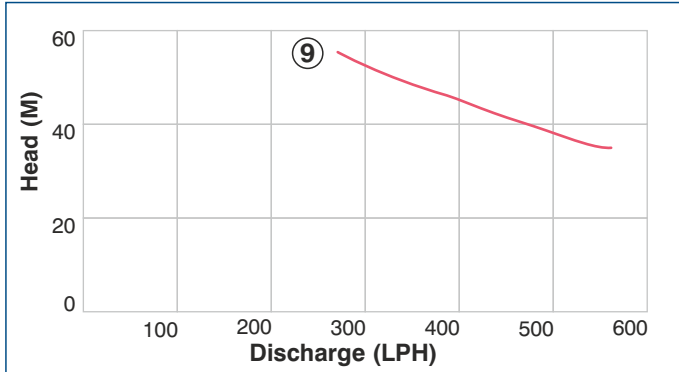
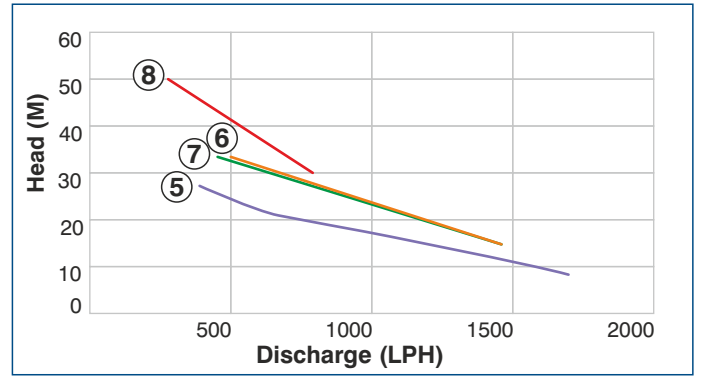
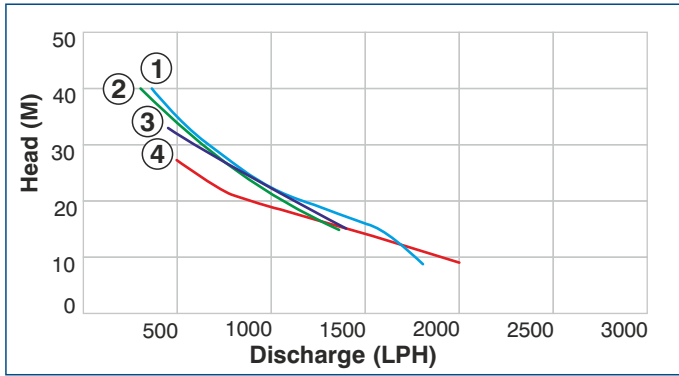

Performance Table:

| Sr. No. | Rating | Motor | | Min. Clear Borewell Dia in mm | Pipe Connections in mm | | | Operating Pressure in kg/sq. cm (meter) | DLWL* in Meter | | | | | | | |
|---------|----------------|-------|-----|-------------------------------|------------------------|----------|----------|---|------------------|------|------|------|-----|-----|-----------|-----|
| | | kW | HP | | Suction | Pressure | Delivery | | 9 | 15 | 21 | 24 | 27 | 30 | 36 | 40 |
| | | | | | | | | | Discharge in LPH | | | | | | | |
| 1 | JPE12/JPE12V | 0.75 | 1.0 | 100 | 32 | 25 | 25 | 1.6 (16) | 1800 | 1560 | 1080 | 910 | 780 | 660 | 460 | 360 |
| 2 | JM12H | 0.75 | 1.0 | 100 | 32 | 25 | 25 | 1.6 (16) | - | 1350 | 970 | 930 | 800 | 680 | 430 | 300 |
| 3 | JCTM12/JCTM12V | 0.75 | 1.0 | 100 | 32 | 25 | 25 | 1.6 (16) | - | 1400 | 1070 | 920 | 760 | 600 | 450 @ 33m | |
| #4 | JCP12 | 0.75 | 1.0 | 80 | 40 | 32 | 25 | 1.6 (16) | 2000 | 1400 | 790 | 640 | 500 | - | - | - |
| #5 | JCP12A | 0.75 | 1.0 | 80 | 32 | 25 | 25 | 1.6 (16) | 1700 | 1200 | 660 | 520 | 400 | - | - | - |
| 6 | JPM1V | 0.75 | 1.0 | 100 | 32 | 25 | 25 | 1.6(16) | - | 1460 | 1140 | 980 | 825 | 660 | 500 @ 33m | |
| 7 | JCTH12L | 0.75 | 1.0 | 115 | 40 | 32 | 25 | 1.4 (14) | - | 1460 | 1240 | 1020 | 800 | 640 | 425@33m | |

| Sr. No. | Rating | Motor | | Min. Clear Borewell Dia in mm | Pipe Connections in mm | | | Operating Pressure in kg/sq. cm (meter) | DLWL* in Meter | | | | | |
|---------|--------|-------|-----|-------------------------------|------------------------|----------|----------|---|------------------|-----|-----|-----|-----|-----|
| | | kW | HP | | Suction | Pressure | Delivery | | 30 | 33 | 36 | 39 | 45 | 50 |
| | | | | | | | | | Discharge in LPH | | | | | |
| 8 | TJM12 | 0.75 | 1.0 | 100 | 32 | 25 | 25 | 1.8 (18) | 790 | 710 | 630 | 540 | 400 | 280 |

| Sr. No. | Rating | Motor | | Min. Clear Borewell Dia in mm | Pipe Connections in mm | | | Operating Pressure in kg/sq. cm (meter) | No of stages | DLWL* in Meter | | | | | | | | | | | | |
|---------|------------------|-------|-----|-------------------------------|------------------------|----------|----------|---|--------------|------------------|-----|-----|-----|-----|-----|-----|-----|-----|-----|-----|-----|---|
| | | kW | HP | | Suction | Pressure | Delivery | | | 35 | 40 | 45 | 50 | 55 | 60 | 65 | 70 | 75 | 80 | 85 | 90 | |
| | | | | | | | | | | Discharge in LPH | | | | | | | | | | | | |
| 9 | JME12(1PH)A-55 | 0.75 | 1.0 | 100 | 32 | 25 | 25 | 3.5(35) | 4 | 560 | 470 | 405 | 330 | 270 | - | - | - | - | - | - | - | - |
| 10 | JME1.52(1PH)A-75 | 1.1 | 1.5 | 100 | 32 | 25 | 25 | 4.2(42) | 6 | - | - | - | 580 | 540 | 470 | 400 | 325 | 200 | - | - | - | - |
| 11 | JME22(1PH)A-90 | 1.5 | 2.0 | 100 | 32 | 25 | 25 | 5.4(54) | 8 | - | - | - | - | - | 560 | 540 | 470 | 370 | 320 | 240 | 140 | |

Note :

- The motor ratings in HP are only indicative and for reference purpose
- Performance figures given above are approximate and may differ on site conditions

- Performance mentioned on nameplate may vary as we are always improving our products
- * DLWL - Depth to low water level
- # Models are with Packer type design

Material of Construction:

| Part | Material |
|--------------------|---------------------------------------|
| Fan | Polypropylene |
| Fan Cowl | Mild Steel |
| Endcover (NDE) | Cast Iron-Grade FG 200 |
| Adaptor (DE) | Cast Iron-Grade FG 200 |
| Impeller | Gun Metal/Noryl/Stainless Steel-SS410 |
| Volute Casing | Cast Iron-Grade FG 200 |
| Diffuser - (TJM12) | Noryl |
| Motor Body | MS/Aluminium/Cast Iron-Grade FG 200 |
| Shaft | Stainless Steel-SS410/EN8 |
| Rotor | Aluminium |
| Nozzel and Venturi | Gun Metal/Noryl |
| Stamping Material | CRNGO-M47 |
| Fasteners | Stainless Steel-SS410 |

Pump Dimensional Details:

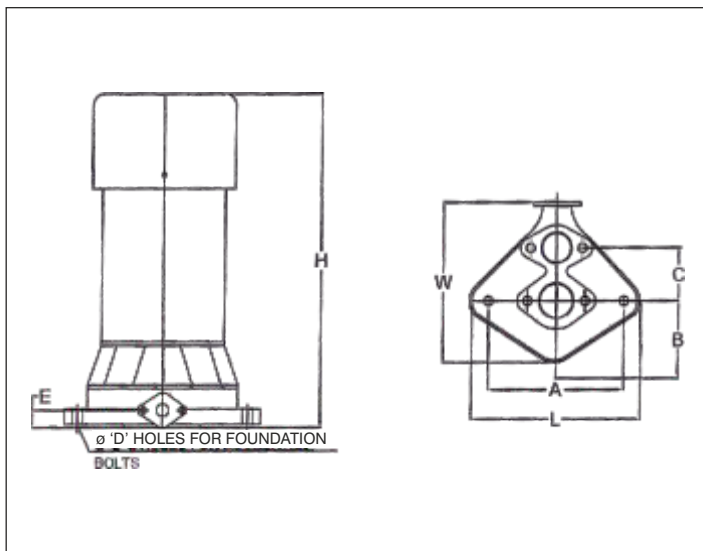

| Model Name | All Dimensions are in mm | | | | | | | |
|------------------|--------------------------|-----|----|----|-----|-----|-----|-----|
| | A | B | C | D | E | L | W | H |
| JPE12/JPE12V | 198 | 92 | 73 | 14 | 50 | 225 | 215 | 410 |
| JM12H | 198 | 104 | 73 | 14 | 50 | 225 | 230 | 310 |
| JCP12/JCP12A | 198 | 113 | 73 | 14 | 50 | 225 | 250 | 410 |
| JCTM12 / JCTM12V | 212 | 92 | 70 | 12 | 25 | 235 | 230 | 380 |
| JCTH12L | 205 | 92 | 70 | 12 | 18 | 235 | 230 | 380 |
| JPM1V | 212 | 92 | 70 | 12 | 25 | 235 | 230 | 405 |
| TJM12 | 190 | 98 | 70 | 11 | 100 | 217 | 196 | 405 |

| Model Name | All Dimensions are in mm | | | | | | | |
|------------------|--------------------------|------|----|----|-----|-----|-----|-----|
| | A | B | C | D | E | L | W | H |
| JME12(1PH)A-55 | 158 | 92.5 | 70 | 12 | 220 | 190 | 195 | 640 |
| JME1.52(1PH)A-75 | 158 | 92.5 | 70 | 12 | 277 | 190 | 195 | 727 |
| JME22(1PH)A-90 | 158 | 92.5 | 70 | 12 | 337 | 190 | 195 | 820 |

3W Series Borewell Submersible Water filled Pumps



High Grade Electrical Stamping

Reduces electrical losses and improves pump efficiency



In Built Check Valve

In built check valve prevents pump parts from damage due to sudden back pressure



High Thrust Capacity

Specially designed thrust bearing ensures highest reliability

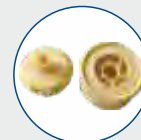

High Quality Noryl

High quality virgin noryl components give longer life



Easy for Maintenance

Simple construction, easily replaceable wear and tear parts

Technical Specifications:

- Range: 0.5 HP to 1.5 HP (0.37 kW to 1.1 kW)
- Rated voltage: 220V for 1PH
- Voltage range: 180V-240V
- Rated Frequency: 50Hz
- Delivery pipe size: 32 mm
- Max. Head: Upto 114 meter
- Max. Discharge: Upto 75 LPM
- Liquid: Clear water
- Motor type: Water filled motor

Application:

- Gardening
- Sprinkler irrigation
- Multistoried buildings
- Water supply for industrial
- Drip irrigation
- Construction sites



Performance Curve:

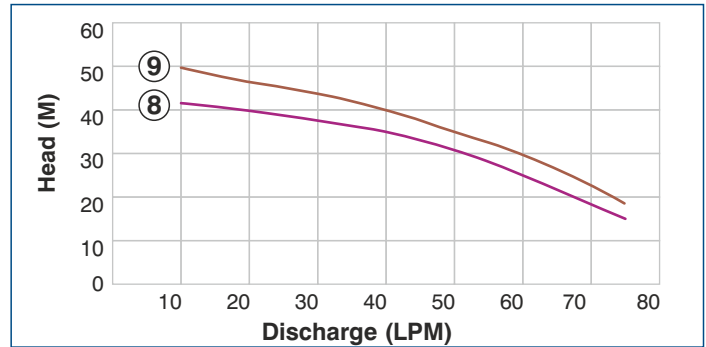
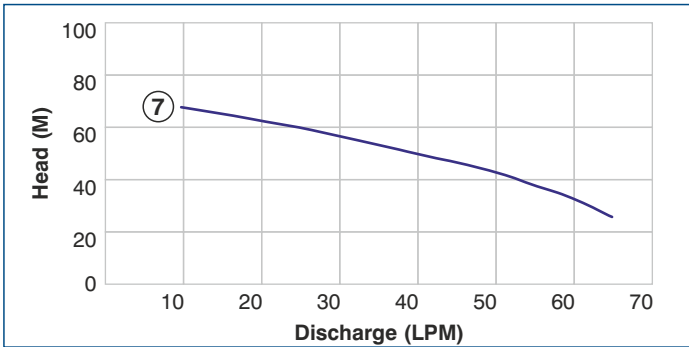
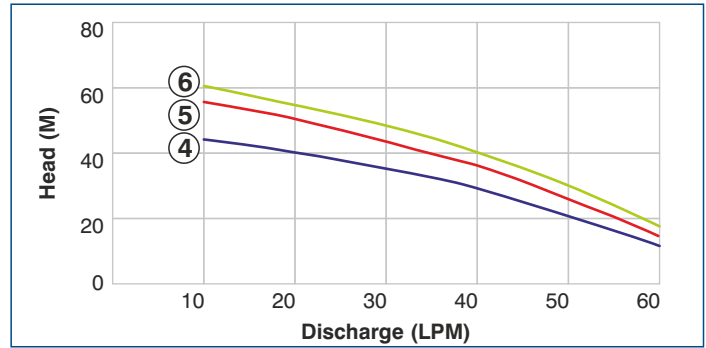
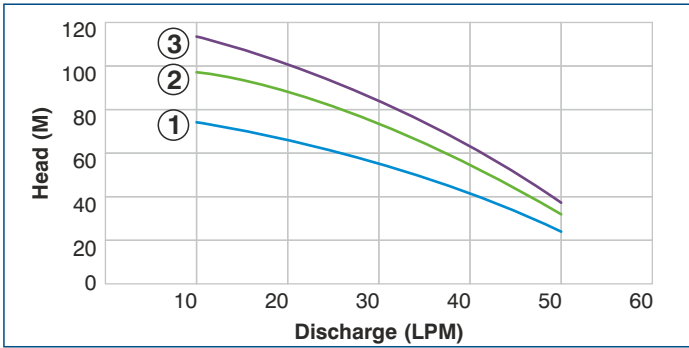

Performance Table:

| Sr. No. | Rating | No. Of Stages | Motor | | Outlet Size mm | Discharge in LPM | | | | | | | Water Filled | | | | | |
|---------|-------------|---------------|-------|------|----------------|------------------|-----|----|----|----|----|----|-----------------------|--|--|---------|-----------------|---------------|
| | | | kW | HP | | 10 | 20 | 25 | 35 | 40 | 45 | 50 | Control Panel | | | MCB (A) | Start Cap (mfd) | Run Cap (mfd) |
| | | | | | | Head in Meter | | | | | | | | | | | | |
| 1 | 3W20AG1D | 20 | 0.75 | 1.0 | 32 | 75 | 67 | 62 | 50 | 42 | 34 | 26 | NDCP1.0-CQ/CDCP1.0-CQ | | | 10 | 100-120 | 50 |
| 2 | 3W26AG1.25D | 26 | 0.93 | 1.25 | 32 | 98 | 87 | 81 | 65 | 55 | 44 | 34 | NDCP1.0-CQ/CDCP1.0-CQ | | | 10 | 100-120 | 50 |
| 3 | 3W30AG1.5D | 30 | 1.1 | 1.5 | 32 | 114 | 101 | 93 | 75 | 63 | 51 | 39 | NDCP1.5-DS/CDCP1.5-DS | | | 13 | 120-150 | 72 |

| Sr. No. | Rating | No. Of Stages | Motor | | Outlet Size mm | Discharge in LPM | | | | | | Water Filled | | | | | |
|---------|----------|---------------|-------|-----|----------------|------------------|----|----|----|----|----|-----------------------|--|--|---------|-----------------|---------------|
| | | | kW | HP | | 10 | 20 | 30 | 40 | 50 | 60 | Control Panel | | | MCB (A) | Start Cap (mfd) | Run Cap (mfd) |
| | | | | | | Head in Meter | | | | | | | | | | | |
| 4 | 3W10AN1D | 10 | 0.75 | 1.0 | 32 | 44 | 40 | 35 | 29 | 21 | 12 | NDCP1.0-CQ/CDCP1.0-CQ | | | 10 | 100-120 | 50 |
| 5 | 3W13AN1D | 13 | 0.75 | 1.0 | 32 | 55 | 50 | 43 | 36 | 26 | 15 | NDCP1.0-CQ/CDCP1.0-CQ | | | 10 | 100-120 | 50 |
| 6 | 3W15AM1D | 15 | 0.75 | 1.0 | 32 | 60 | 54 | 48 | 40 | 30 | 18 | NDCP1.0-CQ/CDCP1.0-CQ | | | 10 | 100-120 | 50 |

| Sr. No. | Rating | No. Of Stages | Motor | | Outlet Size mm | Discharge in LPM | | | | | | | Water Filled | | | | | |
|---------|-------------|---------------|-------|------|----------------|------------------|----|----|----|----|----|----|-----------------------|--|--|---------|-----------------|---------------|
| | | | kW | HP | | 10 | 25 | 40 | 50 | 55 | 60 | 65 | Control Panel | | | MCB (A) | Start Cap (mfd) | Run Cap (mfd) |
| | | | | | | Head in Meter | | | | | | | | | | | | |
| 7 | 3W20AJ1.25D | 20 | 0.93 | 1.25 | 32 | 68 | 60 | 50 | 43 | 38 | 33 | 26 | NDCP1.0-CQ/CDCP1.0-CQ | | | 10 | 100-120 | 50 |

| Sr. No. | Rating | No. Of Stages | Motor | | Outlet Size mm | Discharge in LPM | | | | | | | Water Filled | | | | | |
|---------|----------|---------------|-------|-----|----------------|------------------|------|----|----|----|----|----|-----------------------|--|--|---------|-----------------|---------------|
| | | | kW | HP | | 10 | 20 | 30 | 40 | 50 | 60 | 75 | Control Panel | | | MCB (A) | Start Cap (mfd) | Run Cap (mfd) |
| | | | | | | Head in Meter | | | | | | | | | | | | |
| 8 | 3W10AK1A | 10 | 0.75 | 1.0 | 32 | 42 | 40 | 38 | 35 | 31 | 25 | 15 | NDCP1.0-CQ/CDCP1.0-CQ | | | 10 | 100-120 | 50 |
| 9 | 3W12AK1A | 12 | 0.75 | 1.0 | 32 | 50 | 46.5 | 44 | 40 | 35 | 30 | 19 | NDCP1.0-CQ/CDCP1.0-CQ | | | 10 | 100-120 | 50 |

Performance Curve:

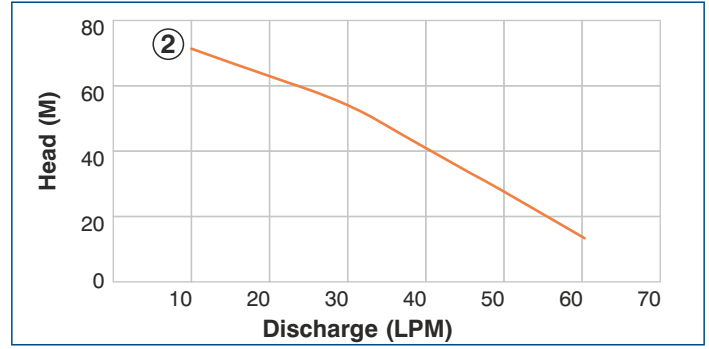
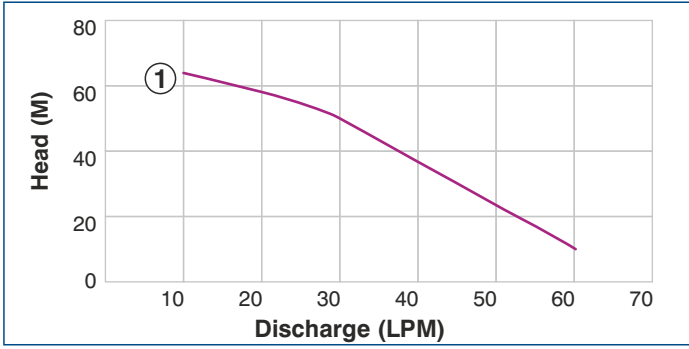

Performance Table:

| Sr. No. | Rating | No. Of Stages | Motor | | Outlet Size mm | Discharge in LPM | | | | | | | | Water Filled | | | |
|---------|----------|---------------|-------|-----|----------------|------------------|----|----|----|----|----|----|-----------------------|--------------|---------|-----------------|---------------|
| | | | kW | HP | | 10 | 20 | 30 | 40 | 50 | 60 | 75 | Control Panel | | MCB (A) | Start Cap (mfd) | Run Cap (mfd) |
| | | | | | | Head in Meter | | | | | | | | | | | |
| 1 | 3W16AL1A | 16 | 0.75 | 1.0 | 32 | 64 | 58 | 50 | 36 | 23 | 10 | - | NDCP1.0-CQ/CDCP1.0-CQ | 10 | 100-120 | 50 | |
| 2 | 3W18AL1A | 18 | 0.75 | 1.0 | 32 | 71 | 63 | 54 | 40 | 27 | 13 | - | NDCP1.0-CQ/CDCP1.0-CQ | 10 | 100-120 | 50 | |

Note :

1. The motor ratings in HP are only indicative and for reference purpose
2. Performance figures given above are approximate and may differ on site conditions

3. Performance mentioned on nameplate may vary as we are always improving our products

Material of Construction:

| No. | Part | Material |
|-----|-----------------------------------|------------------------|
| 1 | Bowl | Noryl |
| 2 | Impeller | Noryl |
| 3 | Pump Shaft | Stainless Steel-SS410 |
| 4 | NRV | Cast Iron Grade FG 200 |
| 5 | Suction Housing | Cast Iron Grade FG 200 |
| 6 | Motor body | Stainless Steel-SS202 |
| 7 | Upper & Lower Housing, Motor Base | Cast Iron Grade FG 200 |
| 8 | Stamping | CRNGO-M47 |
| 9 | Bearing Bush | Bronze LTB-4 |
| 10 | Fasteners | Stainless Steel-SS410 |
| 11 | Strainer | Stainless Steel-SS202 |
| 12 | Sealing | Oil Seal |

Pump Dimensional Details:

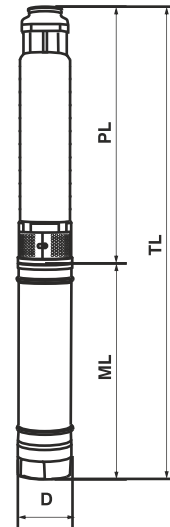

| All Dimensions are in mm | | | | | |
|--------------------------|-----------|------|-------|----|------------|
| Rating | ML | PL | TL | D | |
| | Length mm | | | | Max. OD mm |
| | Motor | Pump | Total | | |
| 3W20AG1D | 510 | 687 | 1159 | 76 | |
| 3W26AG1.25D | 560 | 836 | 1358 | 76 | |
| 3W30AG1.5D | 610 | 935 | 1507 | 76 | |
| 3W10AN1D | 460 | 468 | 890 | 76 | |
| 3W13AN1D | 460 | 541 | 963 | 76 | |
| 3W15AM1D | 460 | 590 | 1012 | 76 | |

| All Dimensions are in mm | | | | | |
|--------------------------|-----------|------|-------|----|------------|
| Rating | ML | PL | TL | D | |
| | Length mm | | | | Max. OD mm |
| | Motor | Pump | Total | | |
| 3W20AJ1.25D | 560 | 1008 | 1530 | 76 | |
| 3W10AK1A | 405 | 455 | 787 | 76 | |
| 3W12AK1A | 405 | 505 | 842 | 76 | |
| 3W16AL1A | 405 | 550 | 892 | 76 | |
| 3W18AL1A | 405 | 600 | 932 | 76 | |

4W Series Borewell Submersible Water filled Pumps





High Grade Electrical Stamping

Reduces electrical losses and improves pump efficiency



High Thrust Capacity

Specially designed thrust bearing ensures highest reliability



In Built Check Valve

In built check valve prevents pump parts from damage due to sudden back pressure



High Quality Noryl

High quality virgin noryl components give longer life



Easy for Maintenance

Simple construction, easily replaceable wear and tear parts

Technical Specifications:

- Range: 0.5 HP to 2.0 HP (0.37 kW to 1.5 kW)
- Rated voltage: 220V for 1PH & 415V for 3PH
- Voltage range: 180V-240V for 1PH & 350V-440V for 3PH
- Rated Frequency: 50Hz
- Delivery pipe size: 32 mm to 65 mm
- Max. Head: Upto 200 meter
- Max. Discharge: Upto 425 LPM
- Liquid: Clear water
- Motor type: Water filled motor

Application:

- Gardening
- Sprinkler irrigation
- Multistoried buildings
- Water supply for industrial
- Drip irrigation
- Construction sites
- Farm Houses



Performance Curve:

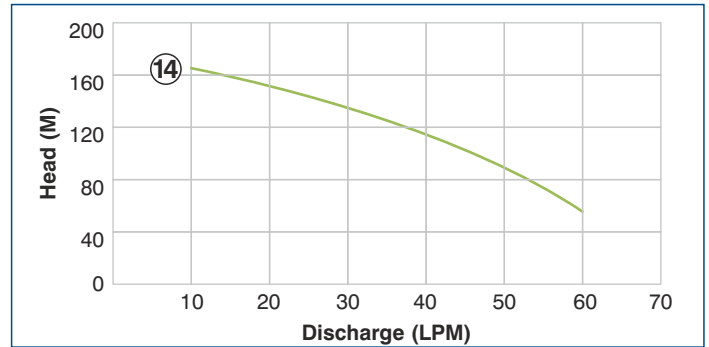
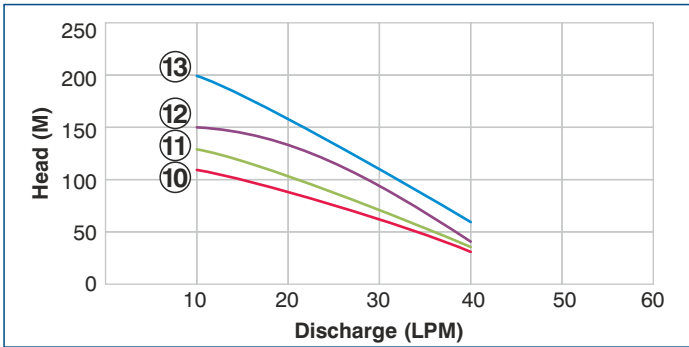
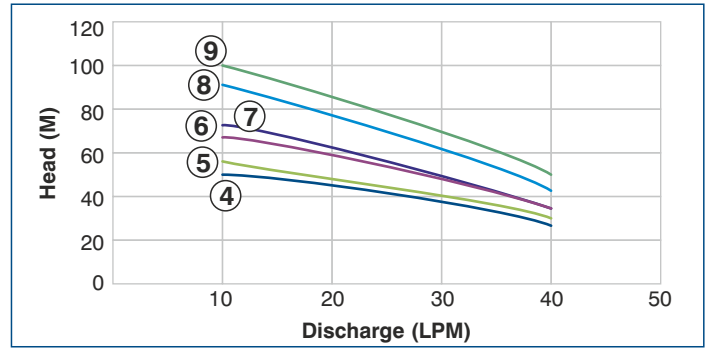
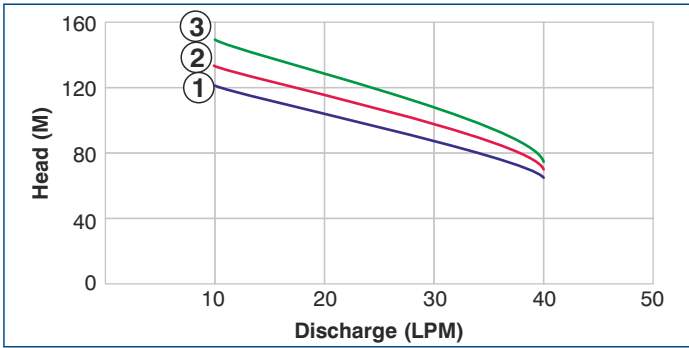

Performance Table:

| Sr. No. | Rating | No. Of Stages | Motor | | Outlet Size mm | Discharge in LPM | | | | | | | Water Filled | | | |
|---------|--------------|---------------|-------|------|----------------|------------------|-----|-----|-----|-----|-----|----|-------------------------|---------|-----------------|---------------|
| | | | kW | HP | | 10 | 15 | 20 | 25 | 30 | 35 | 40 | Control Panel | MCB (A) | Start Cap (mfd) | Run Cap (mfd) |
| | | | | | | Head in Meter | | | | | | | | | | |
| 1 | 4W18K1.5J-VX | 18 | 1.1 | 1.5 | 32 | 121 | 112 | 105 | 97 | 87 | 76 | 64 | NDCP1.5-DS/CDCP1.5-DS | 13 | 120-150 | 72 |
| 2 | 4W20K1.5J-VX | 20 | 1.1 | 1.5 | 32 | 134 | 124 | 117 | 108 | 97 | 84 | 71 | NDCP1.5-DS/CDCP1.5-DS | 13 | 120-150 | 72 |
| 3 | 4W22K2J-VX | 22 | 1.5 | 2.0 | 32 | 149 | 138 | 128 | 118 | 106 | 94 | 78 | NDCP2-ET/CDCP2-ET | 16 | 150-200 | 100 |
| 4 | 4W8AV0.5A | 8 | 0.37 | 0.5 | 32 | 51 | 50 | 47 | 42 | 36 | 31 | 27 | NDCP0.5-BP/CDCP0.5-BP | 6 | 80-100 | 36 |
| 5 | 4W9AV0.75A | 9 | 0.55 | 0.75 | 32 | 57 | 54 | 51 | 46 | 40 | 34 | 30 | NDCP0.75-BQ/CDCP0.75-BQ | 8 | 80-100 | 50 |
| 6 | 4W11AV0.75A | 11 | 0.55 | 0.75 | 32 | 68 | 64 | 60 | 55 | 49 | 42 | 35 | NDCP0.75-BQ/CDCP0.75-BQ | 8 | 80-100 | 50 |
| 7 | 4W11AV1A | 11 | 0.75 | 1.0 | 32 | 72 | 68 | 64 | 58 | 51 | 45 | 35 | NDCP1.0-CQ/CDCP1.0-CQ | 10 | 100-120 | 50 |
| 8 | 4W14AV1A | 14 | 0.75 | 1.0 | 32 | 91 | 84 | 77 | 70 | 61 | 52 | 42 | NDCP1.0-CQ/CDCP1.0-CQ | 10 | 100-120 | 50 |
| 9 | 4W16AV1A | 16 | 0.75 | 1.0 | 32 | 100 | 93 | 86 | 78 | 71 | 62 | 50 | NDCP1.0-CQ/CDCP1.0-CQ | 10 | 100-120 | 50 |
| 10 | 4W18AV1A | 18 | 0.75 | 1.0 | 32 | 110 | 102 | 94 | 84 | 76 | 54 | 30 | NDCP1.0-CQ/CDCP1.0-CQ | 10 | 100-120 | 50 |
| 11 | 4W21AV1A | 21 | 0.75 | 1.0 | 32 | 122 | 114 | 106 | 96 | 84 | 60 | 35 | NDCP1.0-CQ/CDCP1.0-CQ | 10 | 100-120 | 50 |
| 12 | 4W25AV1.5A | 25 | 1.1 | 1.5 | 32 | 150 | 140 | 130 | 117 | 105 | 75 | 40 | NDCP1.5-DS/CDCP1.5-DS | 13 | 120-150 | 72 |
| 13 | 4W32AV2A | 32 | 1.5 | 2.0 | 32 | 200 | 190 | 180 | 165 | 150 | 110 | 60 | NDCP2-ET/CDCP2-ET | 16 | 150-200 | 100 |

| Sr. No. | Rating | No. Of Stages | Motor | | Outlet Size mm | Discharge in LPM | | | | | | Water Filled | | | |
|---------|------------|---------------|-------|-----|----------------|------------------|-----|-----|-----|----|----|-------------------|---------|-----------------|---------------|
| | | | kW | HP | | 10 | 20 | 30 | 40 | 50 | 60 | Control Panel | MCB (A) | Start Cap (mfd) | Run Cap (mfd) |
| | | | | | | Head in Meter | | | | | | | | | |
| 14 | 4W27L2J-VX | 27 | 1.5 | 2.0 | 40 | 166 | 151 | 132 | 108 | 81 | 55 | NDCP2-ET/CDCP2-ET | 16 | 150-200 | 100 |

Performance Curve:

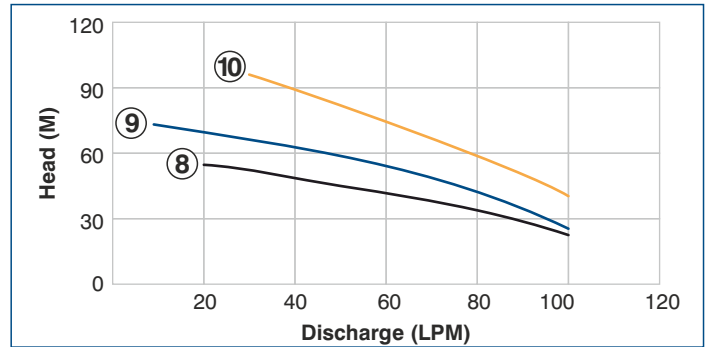
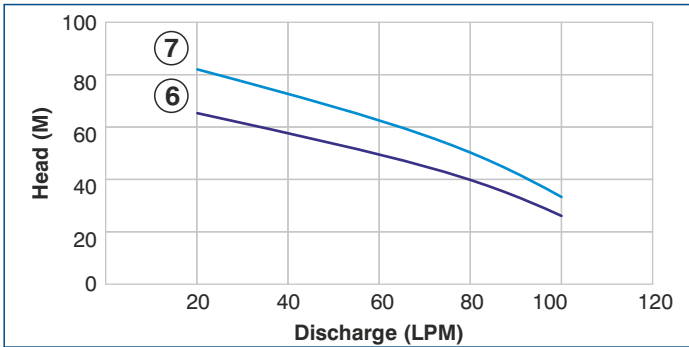
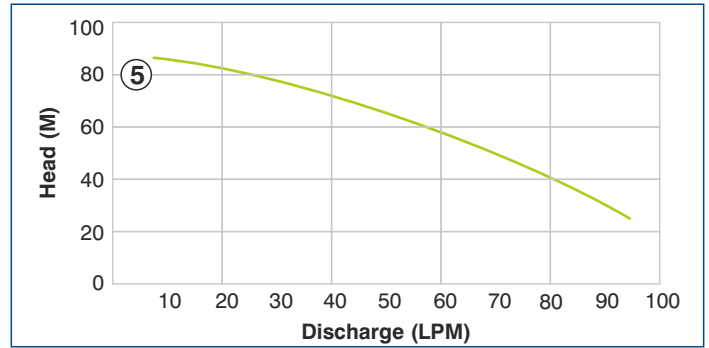
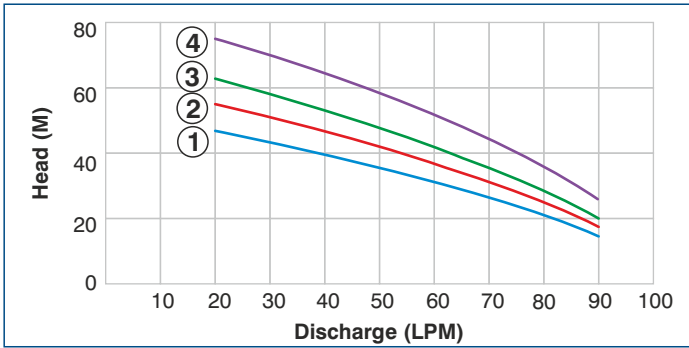

Performance Table:

| Sr. No. | Rating | No. Of Stages | Motor | | Outlet Size mm | Discharge in LPM | | | | | | | | Water Filled | | | |
|---------|----------------------|---------------|-------|-----|----------------|------------------|----|----|----|----|----|----|-----------------------|--------------|-----------------|---------------|--|
| | | | kW | HP | | 20 | 30 | 40 | 50 | 60 | 70 | 90 | Control Panel | MCB (A) | Start Cap (mfd) | Run Cap (mfd) | |
| | | | | | | Head in Meter | | | | | | | | | | | |
| 1 | 4W6RL1C/4W6RL1C-40 | 6 | 0.75 | 1.0 | 32/40 | 47 | 42 | 39 | 36 | 33 | 27 | 15 | NDCP1.0-CQ/CDCP1.0-CQ | 10 | 100-120 | 50 | |
| 2 | 4W7RL1C/4W7RL1C-40 | 7 | 0.75 | 1.0 | 32/40 | 55 | 50 | 46 | 42 | 38 | 32 | 18 | NDCP1.0-CQ/CDCP1.0-CQ | 10 | 100-120 | 50 | |
| 3 | 4W8RL1C/4W8RL1C-40 | 8 | 0.75 | 1.0 | 32/40 | 62 | 57 | 52 | 48 | 43 | 36 | 20 | NDCP1.0-CQ/CDCP1.0-CQ | 10 | 100-120 | 50 | |
| 4 | 4W10RL1C/4W10RL1C-40 | 10 | 0.75 | 1.0 | 32/40 | 75 | 70 | 66 | 60 | 54 | 46 | 26 | NDCP1.0-CQ/CDCP1.0-CQ | 10 | 100-120 | 50 | |

| Sr. No. | Rating | No. Of Stages | Motor | | Outlet Size mm | Discharge in LPM | | | | | | | | Water Filled | | | |
|---------|---------------------------|---------------|-------|-----|----------------|------------------|----|----|----|----|----|----|-----------------------|--------------|-----------------|---------------|--|
| | | | kW | HP | | 10 | 20 | 40 | 50 | 70 | 90 | 95 | Control Panel | MCB (A) | Start Cap (mfd) | Run Cap (mfd) | |
| | | | | | | Head in Meter | | | | | | | | | | | |
| 5 | 4W14BF1.5E/ 4W14BF1.5E-40 | 14 | 1.1 | 1.5 | 32/40 | 88 | 84 | 75 | 66 | 52 | 30 | 25 | NDCP1.5-DS/CDCP1.5-DS | 13 | 120-150 | 72 | |

| Sr. No. | Rating | No. Of Stages | Motor | | Outlet Size mm | Discharge in LPM | | | | | | Water Filled | | | |
|---------|--------------|---------------|-------|-----|----------------|------------------|----|----|----|----|-----|-----------------------|---------|-----------------|---------------|
| | | | kW | HP | | 10 | 20 | 30 | 50 | 70 | 100 | Control Panel | MCB (A) | Start Cap (mfd) | Run Cap (mfd) |
| | | | | | | Head in Meter | | | | | | | | | |
| 6 | 4W10B1.5J-VX | 10 | 1.1 | 1.5 | 40 | - | 67 | 64 | 56 | 47 | 27 | NDCP1.5-DS/CDCP1.5-DS | 13 | 120-150 | 72 |
| 7 | 4W12B1.5J-VX | 12 | 1.1 | 1.5 | 40 | - | 81 | 77 | 68 | 56 | 33 | NDCP1.5-DS/CDCP1.5-DS | 13 | 120-150 | 72 |
| 8 | 4W8B1J-VX | 8 | 0.75 | 1.0 | 40 | - | 54 | 51 | 45 | 38 | 22 | NDCP1.0-CS/CDCP1.0-CS | 10 | 100-120 | 72 |
| 9 | 4W9B1.5J-VX | 9 | 1.1 | 1.5 | 32 | 73 | 63 | 60 | 54 | 47 | 26 | NDCP1.5-DS/CDCP1.5-DS | 13 | 120-150 | 72 |
| 10 | 4W15B2J-VX | 15 | 1.50 | 2.0 | 40 | - | - | 96 | 85 | 71 | 41 | NDCP2-ET/CDCP2-ET | 16 | 150-200 | 100 |

Performance Curve:

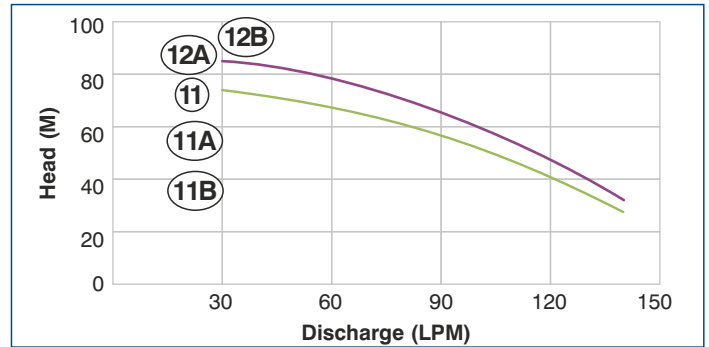
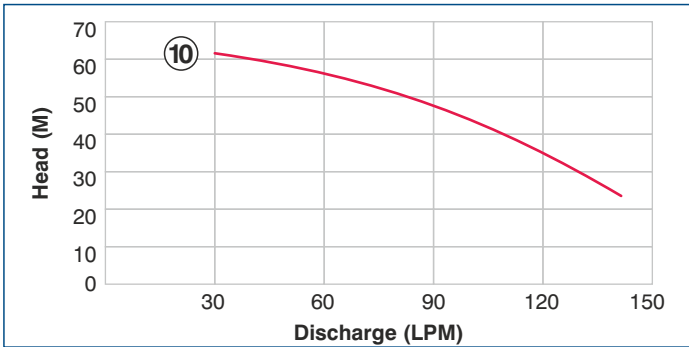
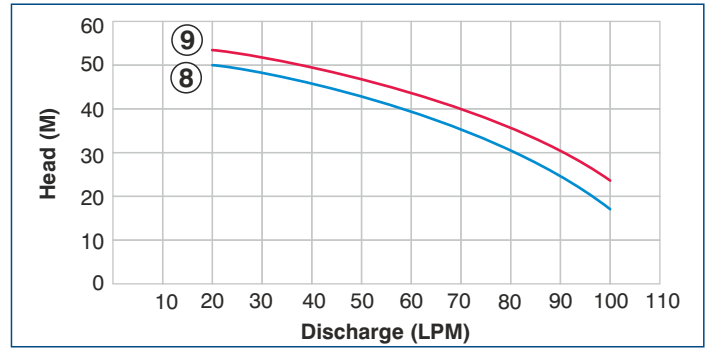
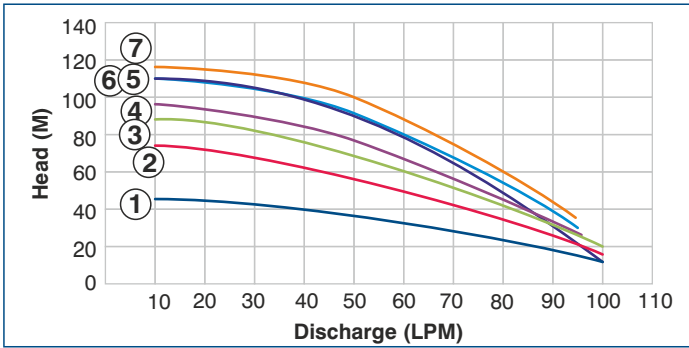

Performance Table:

| Sr. No. | Rating | No. Of Stages | Motor | | Outlet Size mm | Discharge in LPM | | | | | | Water Filled | | | |
|---------|---------------------------|---------------|-------|-----|----------------|------------------|-----|----|----|----|--------|-----------------------|---------|-----------------|---------------|
| | | | kW | HP | | 10 | 20 | 30 | 50 | 70 | 100 | Control Panel | MCB (A) | Start Cap (mfd) | Run Cap (mfd) |
| | | | | | | Head in Meter | | | | | | | | | |
| 1 | 4W7BS1E/4W7BS1E-40 | 7 | 0.75 | 1.0 | 32/40 | 45 | 41 | 38 | 29 | 18 | 12 | NDCP1.0-CQ/CDCP1.0-CQ | 10 | 100-120 | 50 |
| 2 | 4W12BF1.5E/4W12BF1.5E-40 | 12 | 1.1 | 1.5 | 32/40 | 74 | 65 | 60 | 46 | 26 | 16 | NDCP1.5-DS/CDCP1.5-DS | 13 | 120-150 | 72 |
| 3 | 4W14BF2E/4W14BF2E-40 | 14 | 1.5 | 2.0 | 32/40 | 88 | 76 | 70 | 53 | 32 | 20 | NDCP2-ET/CDCP2-ET | 16 | 150-200 | 100 |
| 4 | 4W16BF1.5E/ 4W16BF1.5E-40 | 16 | 1.1 | 1.5 | 32/40 | 94 | 84 | 76 | 57 | 33 | 95@26M | NDCP1.5-DS/CDCP1.5-DS | 13 | 120-150 | 72 |
| 5 | 4W18BF1.5E/ 4W18BF1.5E-40 | 18 | 1.1 | 1.5 | 32/40 | 110 | 100 | 95 | 80 | 60 | 15 | NDCP1.5-DS/CDCP1.5-DS | 13 | 120-150 | 72 |
| 6 | 4W18BF2E/ 4W18BF2E-40 | 18 | 1.5 | 2.0 | 32/40 | 110 | 98 | 90 | 68 | 40 | 95@30M | NDCP2-ET/CDCP2-ET | 16 | 150-200 | 100 |
| 7 | 4W20BF2E/ 4W20BF2E-40 | 20 | 1.5 | 2.0 | 32/40 | 118 | 105 | 98 | 72 | 42 | 95@35M | NDCP2-ET/CDCP2-ET | 16 | 150-200 | 100 |

| Sr. No. | Rating | No. Of Stages | Motor | | Outlet Size mm | Discharge in LPM | | | | | | | Water Filled | | | |
|---------|---------|---------------|-------|-----|----------------|------------------|----|----|----|----|----|-----|-----------------------|---------|-----------------|---------------|
| | | | kW | HP | | 20 | 40 | 60 | 70 | 80 | 90 | 100 | Control Panel | MCB (A) | Start Cap (mfd) | Run Cap (mfd) |
| | | | | | | Head in Meter | | | | | | | | | | |
| 8 | 4W7AU1A | 7 | 0.75 | 1.0 | 40 | 50 | 45 | 40 | 34 | 30 | 24 | 18 | NDCP1.0-CQ/CDCP1.0-CQ | 10 | 100-120 | 50 |
| 9 | 4W8AU1A | 8 | 0.75 | 1.0 | 40 | 53 | 48 | 42 | 38 | 34 | 28 | 24 | NDCP1.0-CQ/CDCP1.0-CQ | 10 | 100-120 | 50 |

| Sr. No. | Rating | No. Of Stages | Motor | | Outlet Size mm | Discharge in LPM | | | | | Water Filled | | | |
|---------|------------------|---------------|-------|-----|----------------|------------------|----|----|-----|-----|-------------------|---------|-----------------|---------------|
| | | | kW | HP | | 30 | 50 | 70 | 100 | 140 | Control Panel | MCB (A) | Start Cap (mfd) | Run Cap (mfd) |
| | | | | | | Head in Meter | | | | | | | | |
| 10 | 4W10C2J-50-VX | 10 | 1.5 | 2.0 | 50 | 61 | 58 | 55 | 44 | 23 | NDCP2-ET/CDCP2-ET | 16 | 150-200 | 100 |
| 11 | 4W12C2J-VX | 12 | 1.5 | 2.0 | 40 | 73 | 70 | 65 | 53 | 28 | NDCP2-ET/CDCP2-ET | 16 | 150-200 | 100 |
| 11A | 4W12C2J-50-VX | 12 | 1.5 | 2.0 | 50 | 73 | 70 | 65 | 53 | 28 | NDCP2-ET/CDCP2-ET | 16 | 150-200 | 100 |
| 11B | 4W12C2TPJ-50-VX* | 12 | 1.5 | 2.0 | 50 | 73 | 70 | 65 | 53 | 28 | - | - | - | - |
| 12A | 4W14C2J-VX | 14 | 1.5 | 2.0 | 40 | 85 | 80 | 74 | 62 | 32 | NDCP2-ET/CDCP2-ET | 16 | 150-200 | 100 |
| 12B | 4W14C2TPJ-VX* | 14 | 1.5 | 2.0 | 40 | 85 | 80 | 74 | 62 | 32 | - | - | - | - |

Performance Curve:

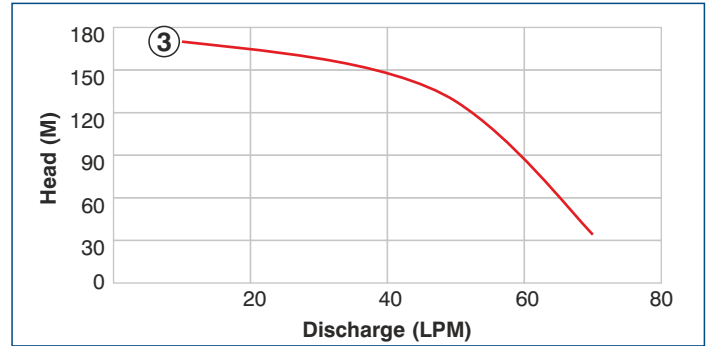
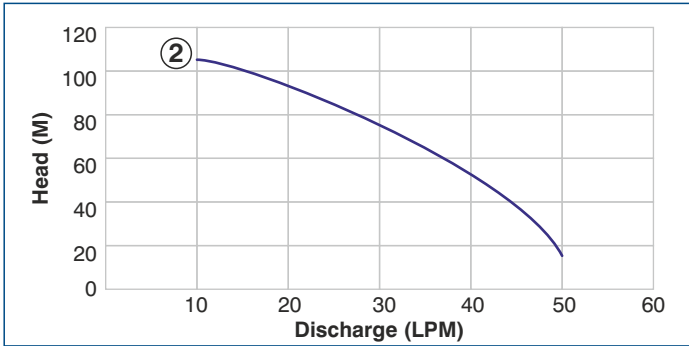
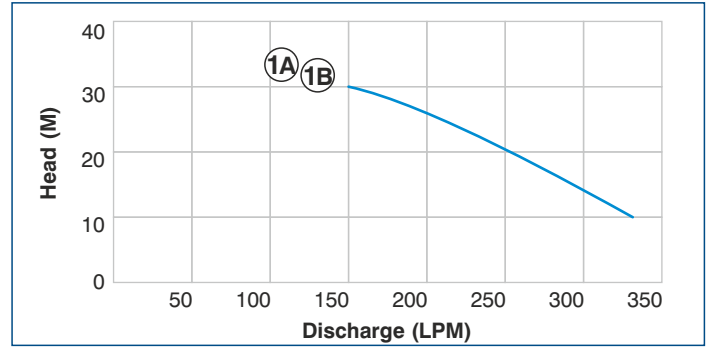
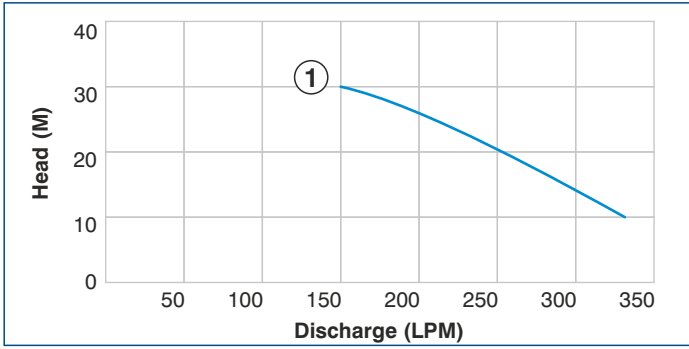

Performance Table:

| Sr. No. | Rating | No. Of Stages | Motor | | Outlet Size mm | Discharge in LPM | | | | | | | Water Filled | | | |
|---------|---------------|---------------|-------|-----|----------------|------------------|-----|-----|-----|------|-----|-----|------------------------|---------|---------------|-----------|
| | | | kW | HP | | 100 | 150 | 200 | 250 | 300 | 350 | 420 | Control Panel | MCB (A) | Run Cap (mfd) | Relay (A) |
| | | | | | | Head in Meter | | | | | | | | | | |
| 1 | 4W6BR2D-65 | 6 | 1.5 | 2.0 | 65 | 30 | 28 | 25 | 22 | 18.5 | 15 | 10 | NDCP2-ET/CDCP2-ET | 16 | 150-200 | 100 |
| 1A | 4W6BR2DTP-65* | 6 | 1.5 | 2.0 | 65 | 30 | 28 | 25 | 22 | 18.5 | 15 | 10 | - | - | - | - |
| 1B | 4W6BR2D(I)-65 | 5 | 1.5 | 2.0 | 65 | 30 | 28 | 25 | 22 | 18.5 | 15 | 10 | DGP2-NS(I)/ADGP2-NS(I) | 25 | 36+36 | 9-14 |

| Sr. No. | Rating | No. Of Stages | Motor | | Outlet Size mm | Discharge in LPM | | | | Water Filled | | | |
|---------|----------|---------------|-------|-----|----------------|------------------|----|----|----|-----------------------|---------|-----------------|---------------|
| | | | kW | HP | | 10 | 20 | 30 | 50 | Control Panel | MCB (A) | Start Cap (mfd) | Run Cap (mfd) |
| | | | | | | Head in Meter | | | | | | | |
| 2 | 4W16RI1C | 16 | 0.75 | 1.0 | 32 | 105 | 94 | 77 | 17 | NDGP1.0-CQ/CDGP1.0-CQ | 10 | 100-120 | 50 |

| Sr. No. | Rating | No. Of Stages | Motor | | Outlet Size mm | Discharge in LPM | | | | | Water Filled | | | |
|---------|----------|---------------|-------|-----|----------------|------------------|-----|-----|-----|----|-------------------|---------|-----------------|---------------|
| | | | kW | HP | | 10 | 20 | 30 | 50 | 70 | Control Panel | MCB (A) | Start Cap (mfd) | Run Cap (mfd) |
| | | | | | | Head in Meter | | | | | | | | |
| 3 | 4W32RD2C | 32 | 1.5 | 2.0 | 32 | 170 | 165 | 153 | 125 | 37 | NDGP2-ET/CDGP2-ET | 16 | 150-200 | 100 |

Performance Curve:

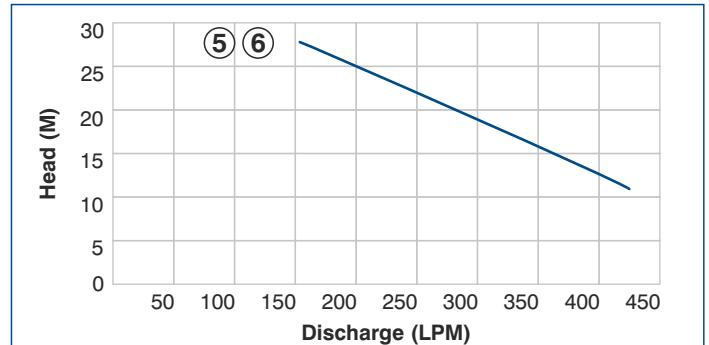
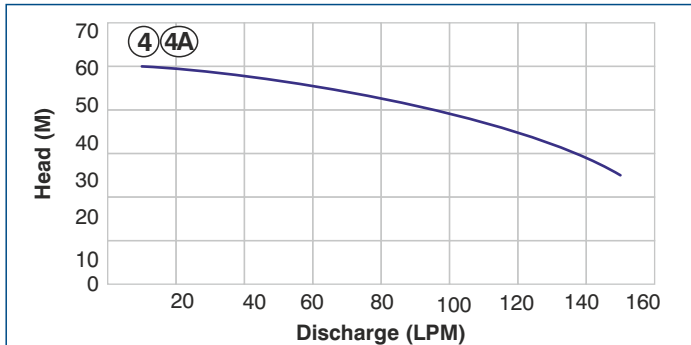
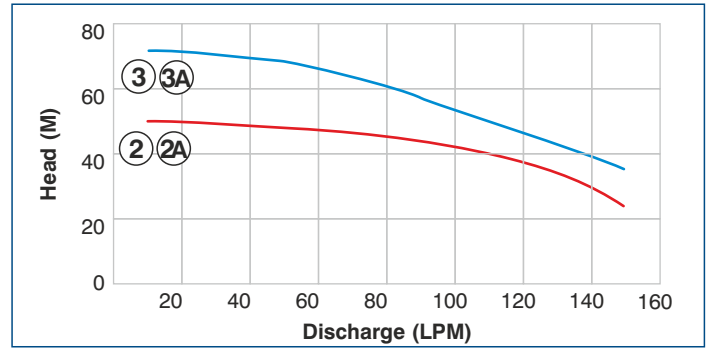
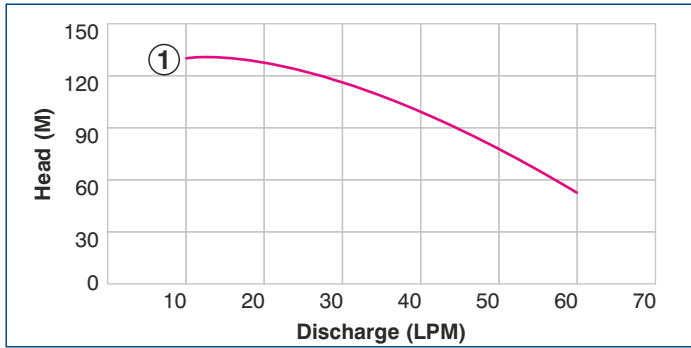

Performance Table:

| Sr. No. | Rating | No. Of Stages | Motor | | Outlet Size mm | Discharge in LPM | | | | | | Water Filled | | | |
|---------|----------|---------------|-------|-----|----------------|------------------|-----|-----|----|----|----|-------------------|---------|-----------------|---------------|
| | | | kW | HP | | 10 | 20 | 30 | 40 | 50 | 60 | Control Panel | MCB (A) | Start Cap (mfd) | Run Cap (mfd) |
| | | | | | | Head in Meter | | | | | | | | | |
| 1 | 4W18RJ2C | 18 | 1.5 | 2.0 | 32 | 128 | 125 | 120 | 97 | 64 | 52 | NDCP2-ET/CDCP2-ET | 16 | 150-200 | 100 |

| Sr. No. | Rating | No. Of Stages | Motor | | Outlet Size mm | Discharge in LPM | | | | | | | | Water Filled | | | |
|---------|---------------|---------------|-------|-----|----------------|------------------|----|----|----|----|----|-----|-----|------------------------|---------|-----------------|---------------|
| | | | kW | HP | | 10 | 20 | 30 | 50 | 80 | 90 | 120 | 150 | Control Panel | MCB (A) | Start Cap (mfd) | Run Cap (mfd) |
| | | | | | | Head in Meter | | | | | | | | | | | |
| 2 | 4W8RA2C | 8 | 1.5 | 2.0 | 38 | 50 | 49 | 49 | 48 | 45 | 44 | 38 | 25 | NDCP2-ET/CDCP2-ET | 16 | 150-200 | 100 |
| 2A | 4W8RA2C-50 | 8 | 1.5 | 2.0 | 50 | 50 | 49 | 49 | 48 | 45 | 44 | 38 | 25 | NDCP2-ET/CDCP2-ET | 16 | 150-200 | 100 |
| 3 | 4W10RA2C | 10 | 1.5 | 2.0 | 38 | 63 | 62 | 61 | 60 | 56 | 53 | 47 | 31 | NDCP2-ET/CDCP2-ET | 16 | 150-200 | 100 |
| 3A | 4W10RA2C-50 | 10 | 1.5 | 2.0 | 50 | 63 | 62 | 61 | 60 | 56 | 53 | 47 | 31 | NDCP2-ET/CDCP2-ET | 16 | 150-200 | 100 |
| 4 | 4W8RA2C(I) | 8 | 1.5 | 2.0 | 38 | 50 | 49 | 49 | 48 | 45 | 44 | 38 | 25 | DCP2-NS(I)/ADCP2-NS(I) | 25 | 36+36 | 9-14 |
| 4A | 4W8RA2C-50(I) | 8 | 1.5 | 2.0 | 50 | 50 | 49 | 49 | 48 | 45 | 44 | 38 | 25 | DCP2-NS(I)/ADCP2-NS(I) | 25 | 36+36 | 9-14 |

| Sr. No. | Rating | No. Of Stages | Motor | | Outlet Size mm | Discharge in LPM | | | | | | | Water Filled | | | |
|---------|---------------|---------------|-------|-----|----------------|------------------|-----|-----|-----|-----|-----|-----|------------------------|---------|-----------------|---------------|
| | | | kW | HP | | 155 | 210 | 260 | 315 | 365 | 400 | 425 | Control Panel | MCB (A) | Start Cap (mfd) | Run Cap (mfd) |
| | | | | | | Head in Meter | | | | | | | | | | |
| 5 | 4W6MQ2C-65 | 6 | 1.5 | 2.0 | 65 | 28 | 25 | 21 | 18 | 15 | 13 | 11 | NDCP2-ET/CDCP2-ET | 16 | 150-200 | 100 |
| 6 | 4W6MQ2C(I)-65 | 6 | 1.5 | 2.0 | 65 | 28 | 25 | 21 | 18 | 15 | 13 | 11 | DCP2-NS(I)/ADCP2-NS(I) | 25 | 36+36 | 9-14 |

Note :

1. The motor ratings in HP are only indicative and for reference purpose
2. Performance figures given above are approximate and may differ on site conditions

3. Performance mentioned on nameplate may vary as we are always improving our products
4. * Only 3 phase models

Pump Dimensional Details:

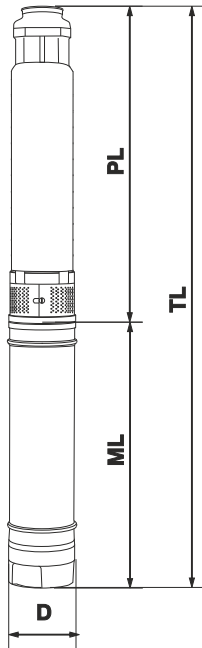

Material of Construction:

| No. | Part | Material |
|-----|---------------------------|-----------------------------|
| 1 | Diffuser | Noryl |
| 2 | Impeller | Noryl/Delrin |
| 3 | Pump Shaft | Stainless Steel-SS410 |
| 4 | NRV Body | Cast Iron-Grade FG 200 |
| 5 | Motor Body | Stainless Steel-SS202/SS304 |
| 6 | Pump Jacket | Cast Iron-Grade FG 200 |
| 7 | Upper Housing, Motor Base | Stainless Steel-SS202 |
| 8 | Bush | Bronze LTB-4 |
| 9 | Motor Shaft | Stainless Steel-SS420 |
| 10 | Stamping | CRNGO-M47 |
| 11 | Thrust Bearing | SS Vs Zytel / SS Vs Carbon |
| 12 | Strainer | Stainless Steel-SS202 |
| 13 | Fastener | Stainless Steel-SS410 |
| 14 | Sealing | Oil seal |

| All Dimensions are in mm | | | | |
|--------------------------|-----------|------|-------|--------------------|
| Rating | ML | PL | TL | D Max. OD mm |
| | Length mm | | | |
| | Motor | Pump | Total | |
| 4W18K1.5J-VX | 475 | 665 | 1100 | 98 |
| 4W20K1.5J-VX | 470 | 710 | 1140 | 98 |
| 4W22K2J-VX | 520 | 750 | 1230 | 98 |
| 4W8AV0.5A | 380 | 380 | 720 | 98 |
| 4W9AV0.75A | 395 | 405 | 760 | 98 |
| 4W11AV0.75A | 395 | 450 | 805 | 98 |
| 4W11AV1A | 405 | 455 | 820 | 98 |
| 4W14AV1A | 415 | 510 | 885 | 98 |
| 4W16AV1A | 415 | 585 | 960 | 98 |
| 4W18AV1A | 450 | 730 | 1170 | 98 |
| 4W21AV1A | 480 | 825 | 1265 | 98 |
| 4W25AV1.5A | 480 | 400 | 750 | 98 |
| 4W32AV2A | 510 | 1000 | 1470 | 98 |
| 4W27L2J-VX | 520 | 865 | 1345 | 98 |
| 4W6RL1C/4W6RL1C-40 | 349 | 381 | 730 | 98 |
| 4W7RL1C/4W7RL1C-40 | 379 | 406 | 785 | 98 |
| 4W8RL1C/4W8RL1C-40 | 379 | 430 | 809 | 98 |
| 4W10RL1C/4W10RL1C-40 | 399 | 480 | 879 | 98 |
| 4W14BF1.5E/4W14BF1.5E-40 | 435 | 589 | 1024 | 98 |
| 4W10B1.5J-VX | 475 | 460 | 895 | 98 |
| 4W12B1.5J-VX | 475 | 535 | 970 | 98 |
| 4W8B1J-VX | 450 | 410 | 820 | 98 |
| 4W9B1.5J-VX | 475 | 430 | 865 | 98 |
| 4W15B2J-VX | 520 | 610 | 1090 | 98 |
| 4W7BS1E/4W7BS1E-40 | 390 | 414 | 804 | 98 |

| All Dimensions are in mm | | | | |
|---|-----------|------|-------|--------------------|
| Rating | ML | PL | TL | D Max. OD mm |
| | Length mm | | | |
| | Motor | Pump | Total | |
| 4W15B2J-VX | 520 | 610 | 1090 | 98 |
| 4W7BS1E/4W7BS1E-40 | 390 | 414 | 804 | 98 |
| 4W12BF1.5E/4W12BF1.5E-40 | 421 | 539 | 960 | 98 |
| 4W14BF2E/4W14BF2E-40 | 461 | 589 | 1050 | 98 |
| 4W16BF1.5E/ 4W16BF1.5E-40 | 461 | 639 | 1100 | 98 |
| 4W18BF1.5E/ 4W18BF1.5E-40 | 485 | 689 | 1174 | 98 |
| 4W18BF2E/4W18BF2E-40 | 485 | 689 | 1174 | 98 |
| 4W20BF2E/4W20BF2E-40 | 485 | 739 | 1224 | 98 |
| 4W7AU1A | 390 | 400 | 750 | 98 |
| 4W8AU1A | 420 | 420 | 800 | 98 |
| 4W10C2J-50-VX | 520 | 575 | 1060 | 98 |
| 4W12C2J-VX/4W12C2J-50-VX | 520 | 615 | 1095 | 98 |
| 4W12C2TPJ-50-VX | 520 | 615 | 1095 | 98 |
| 4W14C2J-VX/4W14C2TPJ-VX | 520 | 675 | 1155 | 98 |
| 4W6BR2D-65/4W6BR2DTP-65/ 4W6BR2D(I)-65 | 550 | 587 | 1137 | 98 |
| 4W16RI1C | 419 | 695 | 1076 | 98 |
| 4W32RD2C | 484 | 1088 | 1534 | 98 |
| 4W18RJ2C | 484 | 444 | 890 | 98 |
| 4W8RA2C/4W8RA2C(I) | 449 | 493 | 904 | 98 |
| 4W8RA2C-50/4W8RA2C-50(I) | 449 | 493 | 904 | 98 |
| 4W10RA2C | 484 | 559 | 1005 | 98 |
| 4W10RA2C-50 | 484 | 559 | 1005 | 98 |
| 4W6MQ2C-65/4W6MQ2C(I)-65 | 484 | 773 | 1219 | 98 |

3VO / 4VO Series Borewell Submersible Oil filled Pumps



High Grade Electrical Stamping

Reduces electrical losses and improves pump efficiency



Anti-Rust CED Coating

Offers rust free and stuck free operation



Reliable Mechanical Seal

High quality and long life mechanical seal



High Quality Noryl

High quality virgin noryl components give longer life



Easy for Maintenance

Simple construction, easily replaceable wear and tear parts

Technical Specifications:

- Range: 0.5 HP to 2.0 HP (0.37 kW to 1.5 kW)
- Rated voltage: 220V 1-Phase
- Voltage range: 180V-240V
- Rated Frequency: 50Hz
- Delivery pipe size: 32 mm to 50 mm
- Max. Head: Upto 132 meter
- Max. Discharge: Upto 250 LPM
- Liquid: Clear water
- Motor type: Oil filled motor

Application:

- Gardening
- Sprinkler irrigation
- Multistoried buildings
- Water supply for domestic and industrial application
- Drip irrigation
- Construction site



Performance Curve: 3VO Series

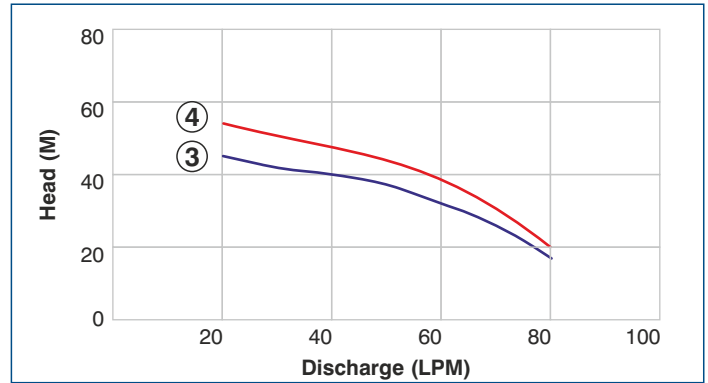
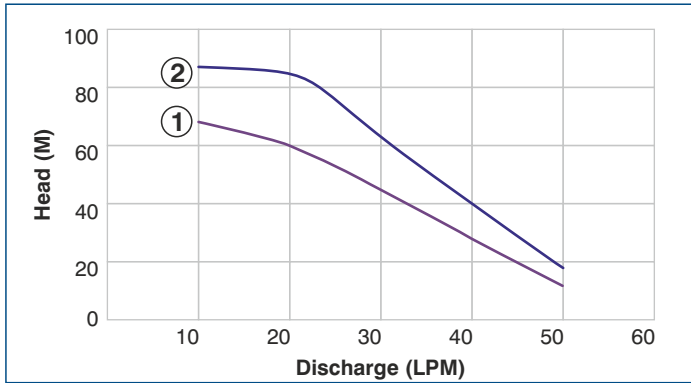

Performance Table: 3VO Series

| Sr. No. | Rating | No. Of Stages | Motor | | Outlet Size mm | Discharge in LPM | | | | | OIL Filled | | |
|---------|-------------|---------------|-------|------|----------------|------------------|----|----|----|----|----------------------|--------------|---------------|
| | | | | | | 10 | 20 | 30 | 40 | 50 | Control Panel | OLP/ MCB (A) | Run Cap (mfd) |
| | | | kW | HP | | Head in Meter | | | | | | | |
| 1 | 3VO25RA1 | 25 | 0.75 | 1.0 | 32 | 68 | 60 | 45 | 28 | 12 | NODCP1-NP/CODCP1-ZP* | 8 | 36 |
| 2 | 3VO36RA1.25 | 36 | 0.93 | 1.25 | 32 | 87 | 86 | 63 | 40 | 18 | NODCP1-NP/CODCP1-ZP* | 8 | 36 |

| Sr. No. | Rating | No. Of Stages | Motor | | Outlet Size mm | Discharge in LPM | | | | | | | OIL Filled | | |
|---------|----------|---------------|-------|-----|----------------|------------------|----|----|----|----|----|----|----------------------|--------------|---------------|
| | | | | | | 20 | 30 | 40 | 50 | 60 | 70 | 80 | Control Panel | OLP/ MCB (A) | Run Cap (mfd) |
| | | | kW | HP | | Head in Meter | | | | | | | | | |
| 3 | 3VO10RC1 | 10 | 0.75 | 1.0 | 32 | 45 | 42 | 40 | 37 | 32 | 26 | 17 | NODCP1-NP/CODCP1-ZP* | 8 | 36 |
| 4 | 3VO12RC1 | 12 | 0.75 | 1.0 | 32 | 54 | 50 | 48 | 44 | 38 | 31 | 20 | NODCP1-NP/CODCP1-ZP* | 8 | 36 |

Note :

1. The motor ratings in HP are only indicative and for reference purpose
2. Performance figures given above are approximate and may differ on site conditions

3. Performance mentioned on nameplate may vary as we are always improving our products
4. *Models with Start Capacitor 40-60 mfd and without contactor

Performance Curve: 4VO Series

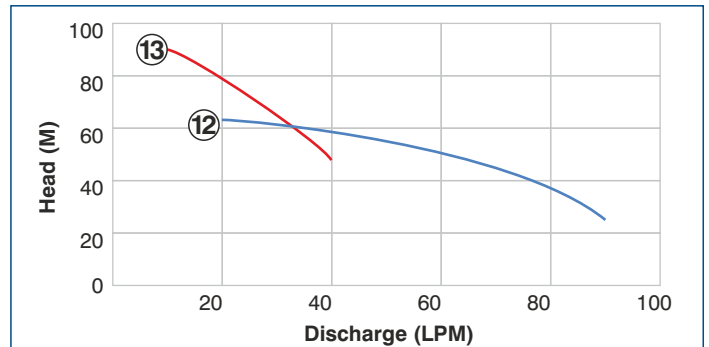
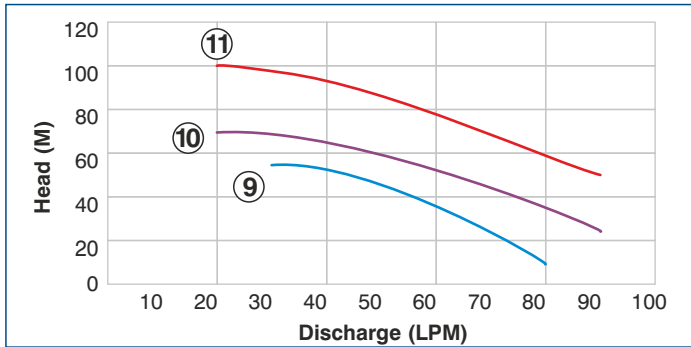
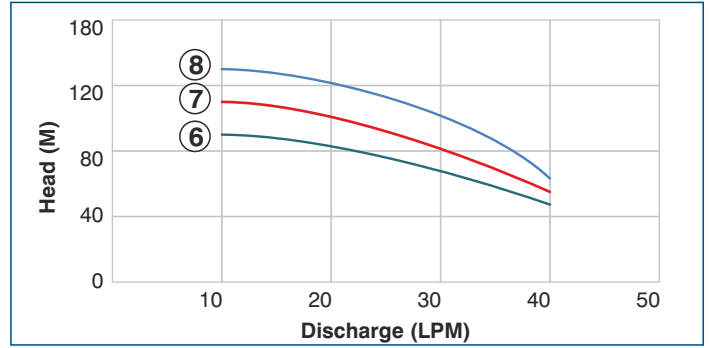
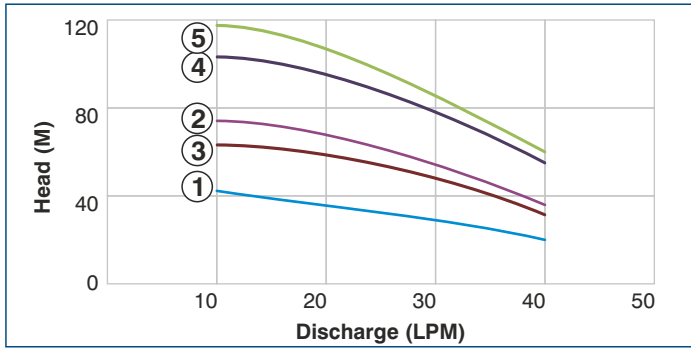

Performance Table: 4VO Series

| Sr. No. | Rating | No. Of Stages | Motor | | Outlet Size mm | Discharge in LPM | | | | Oil Filled | | |
|---------|-------------|---------------|-------|------|----------------|------------------|-----|-----|----|----------------------------|--------------|---------------|
| | | | kW | HP | | 10 | 20 | 30 | 40 | Control Panel | OLP/ MCB (A) | Run Cap (mfd) |
| | | | | | | | | | | | | |
| 1 | 4VO8RE0.5 | 8 | 0.37 | 0.5 | 32 | 42 | 33 | 31 | 20 | NODCP0.5-NM/CODCP0.5-ZM* | 5 | 25 |
| 2 | 4VO14RE0.75 | 14 | 0.55 | 0.75 | 32 | 74 | 67 | 55 | 35 | NODCP0.75-NP/CODCP0.75-ZP* | 6 | 36 |
| 3 | 4VO10RI1 | 10 | 0.75 | 1.0 | 32 | 64 | 57 | 47 | 33 | NODCP1-NP/CODCP1-ZP* | 8 | 36 |
| 4 | 4VO16RI1 | 16 | 0.75 | 1.0 | 32 | 103 | 91 | 75 | 53 | NODCP1-NP/CODCP1-ZP* | 8 | 36 |
| 5 | 4VO18RI1.5 | 18 | 1.1 | 1.5 | 32 | 116 | 102 | 83 | 60 | NODCP1.5-NP/CODCP1.5-ZP* | 12 | 36 |
| 6 | 4VO18RE1 | 18 | 0.75 | 1.0 | 32 | 95 | 86 | 70 | 45 | NODCP1-NP/CODCP1-ZP* | 8 | 36 |
| 7 | 4VO21RE1 | 21 | 0.75 | 1.0 | 32 | 111 | 101 | 82 | 52 | NODCP1-NP/CODCP1-ZP* | 8 | 36 |
| 8 | 4VO25RE1.5 | 25 | 1.1 | 1.5 | 32 | 132 | 120 | 100 | 62 | NODCP1.5-NP/CODCP1.5-ZP* | 12 | 36 |

| Sr. No. | Rating | No. Of Stages | Motor | | Outlet Size mm | Discharge in LPM | | | | | | Oil Filled | | |
|---------|-------------|---------------|-------|-----|----------------|------------------|----|----|----|----|----|--------------------------|--------------|---------------|
| | | | kW | HP | | 20 | 30 | 40 | 60 | 80 | 90 | Control Panel | OLP/ MCB (A) | Run Cap (mfd) |
| | | | | | | | | | | | | | | |
| 9 | 4VO/RJ/1007 | 7 | 0.75 | 1.0 | 32 | - | 51 | 46 | 34 | 12 | - | NODCP1-NP/CODCP1-ZP* | 8 | 36 |
| 10 | 4VO12RC1.5 | 12 | 1.1 | 1.5 | 32 | 68 | 65 | 62 | 50 | 35 | 23 | NODCP1.5-NP/CODCP1.5-ZP* | 12 | 36 |
| 11 | 4VO18RC2 | 18 | 1.5 | 2.0 | 32 | 101 | 97 | 94 | 81 | 63 | 54 | NODCP2-NP/CODCP2-ZP* | 15 | 36 |

| Sr. No. | Rating | No. Of Stages | Motor | | Outlet Size mm | Discharge in LPM | | | | | | | | Oil Filled | | |
|---------|----------|---------------|-------|-----|----------------|------------------|----|----|----|----|----|----|----------------------|--------------|---------------|---------------|
| | | | kW | HP | | 10 | 20 | 30 | 40 | 60 | 80 | 90 | Control Panel | OLP/ MCB (A) | Run Cap (mfd) | |
| | | | | | | | | | | | | | | | | Head in Meter |
| 12 | 4VO8RJ1 | 8 | 0.75 | 1.0 | 32 | - | 63 | 60 | 57 | 47 | 37 | 24 | NODCP1-NP/CODCP1-ZP* | 8 | 36 | |
| 13 | 4VO14RI1 | 14 | 0.75 | 1.0 | 32 | 90 | 79 | 65 | 47 | - | - | - | NODCP1-NP/CODCP1-ZP* | 8 | 36 | |

Performance Curve: 4VO Series

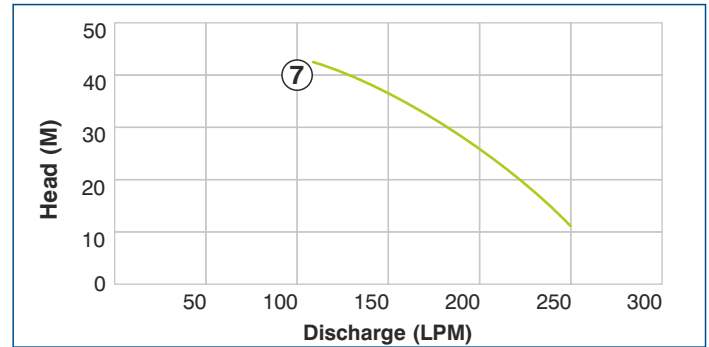
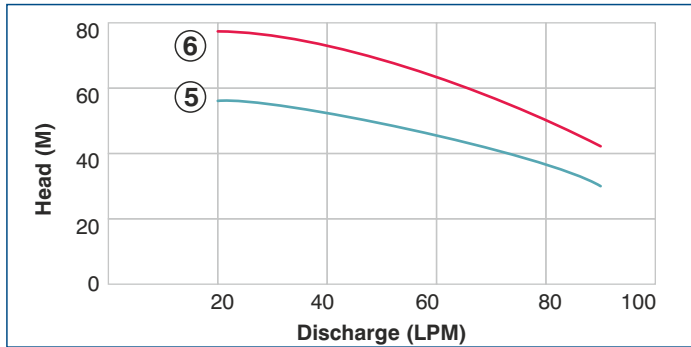
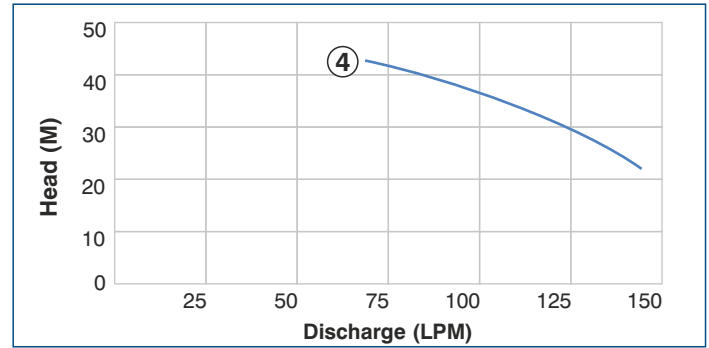
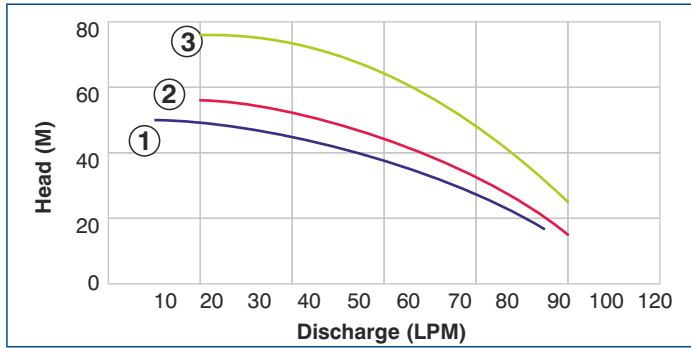

Performance Table: 4VO Series

| Sr. No. | Rating | No. Of Stages | Motor | | Outlet Size mm | Discharge in LPM | | | | | | | | Oil Filled | | |
|---------|-------------|---------------|-------|-----|----------------|------------------|----|----|----|----|----|--------|--------------------------|--------------|---------------|--|
| | | | kW | HP | | 10 | 20 | 40 | 60 | 80 | 90 | 100 | Control Panel | OLP/ MCB (A) | Run Cap (mfd) | |
| | | | | | | Head in Meter | | | | | | | | | | |
| 1 | 4VO7BS1E | 7 | 0.75 | 1.0 | 32 | 50 | 48 | 42 | 34 | 24 | 18 | 95@16M | NODCP1-NP/CODCP1-ZP* | 8 | 36 | |
| 2 | 4VO10AS1E | 10 | 0.75 | 1.0 | 32 | - | 56 | 51 | 43 | 30 | 22 | 14 | NODCP1-NP/CODCP1-ZP* | 8 | 36 | |
| 3 | 4VO14AS1.5E | 14 | 1.1 | 1.5 | 32 | - | 76 | 70 | 63 | 47 | 36 | 24 | NODCP1.5-NP/CODCP1.5-ZP* | 12 | 36 | |

| Sr. No. | Rating | No. Of Stages | Motor | | Outlet Size mm | Discharge in LPM | | | | | | | | Oil Filled | | |
|---------|-----------|---------------|-------|-----|----------------|------------------|----|----|-----|-----|-----|-----|-----|--------------------------|--------------|---------------|
| | | | kW | HP | | 70 | 80 | 90 | 100 | 110 | 120 | 130 | 145 | Control Panel | OLP/ MCB (A) | Run Cap (mfd) |
| | | | | | | Head in Meter | | | | | | | | | | |
| 4 | 4VO7RA1.5 | 7 | 1.1 | 1.5 | 38 | 43 | 42 | 40 | 37 | 35 | 32 | 27 | 22 | NODCP1.5-NP/CODCP1.5-ZP* | 12 | 36 |

| Sr. No. | Rating | No. Of Stages | Motor | | Outlet Size mm | Discharge in LPM | | | | | | | Oil Filled | | |
|---------|------------|---------------|-------|-----|----------------|------------------|----|----|----|----|----|-----|--------------------------|--------------|---------------|
| | | | kW | HP | | 20 | 30 | 40 | 60 | 80 | 90 | 120 | Control Panel | OLP/ MCB (A) | Run Cap (mfd) |
| | | | | | | Head in Meter | | | | | | | | | |
| 5 | 4VO10RC1 | 10 | 0.75 | 1.0 | 32 | 56 | 54 | 52 | 45 | 35 | 30 | - | NODCP1-NP/CODCP1-ZP* | 8 | 36 |
| 6 | 4VO14RC1.5 | 14 | 1.1 | 1.5 | 32 | - | 76 | 73 | 63 | 56 | 42 | - | NODCP1.5-NP/CODCP1.5-ZP* | 12 | 36 |

78

| Sr. No. | Rating | No. Of Stages | Motor | | Outlet Size mm | Discharge in LPM | | | | | | | | Oil Filled | | |
|---------|---------|---------------|-------|-----|----------------|------------------|-----|-----|-----|-----|-----|-----|-----|----------------------|---------|---------------|
| | | | kW | HP | | 110 | 130 | 160 | 190 | 220 | 230 | 240 | 250 | Control Panel | OLP (A) | Run Cap (mfd) |
| | | | | | | Head in Meter | | | | | | | | | | |
| 7 | 4VO8RP2 | 8 | 1.5 | 2.0 | 50 | 43 | 37 | 35 | 27 | 23 | 15 | 13 | 12 | NODCP2-NP/CODCP2-ZP* | 15 | 36 |

Note :

1. The motor ratings in HP are only indicative and for reference purpose
2. Performance figures given above are approximate and may differ on site conditions

3. Performance mentioned on nameplate may vary as we are always improving our products
4. *Models with Start Capacitor 40-60 mfd and without contactor

Pump Dimensional Details:

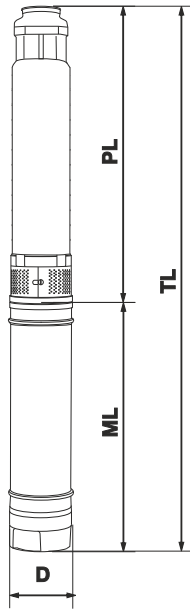

Material of Construction:

| No. | Part | Material |
|-----|---------------|--|
| 1 | Bowl | Noryl |
| 2 | Impeller | Noryl |
| 3 | Pump Shaft | Stainless Steel-SS410 |
| 4 | NRV Body | Cast Iron-Grade FG 200 |
| 5 | Motor Body | Stainless Steel-SS304 |
| 6 | Pump Jacket | Stainless Steel-SS202 |
| 7 | Upper Housing | Cast Iron-Grade FG 200 |
| 8 | Bearing | Standard |
| 9 | Motor Shaft | Stainless Steel-SS410 |
| 10 | Stamping | CRNGO-M47 |
| 11 | Strainer | Stainless Steel-SS202 |
| 12 | Fastener | Stainless Steel-SS410 |
| 13 | Sealing | Oil seal/Mechanical seal (Ceramic Vs Carbon) |
| 14 | Motor Base | Stainless Steel-SS304 |

| All Dimensions are in mm | | | | |
|--------------------------|-----------|------|-------|------------|
| Rating | ML | PL | TL | D |
| | Length mm | | | Max. OD mm |
| | Motor | Pump | Total | |
| 3VO25RA1 | 391 | 838 | 1191 | 76 |
| 3VO36RA1.25 | 416 | 1063 | 1447 | 76 |
| 3VO10RC1 | 391 | 492 | 845 | 76 |
| 3VO12RC1 | 391 | 547 | 900 | 76 |
| 4VO8RE0.5 | 303 | 425 | 690 | 98 |
| 4VO14RE0.75 | 328 | 586 | 876 | 98 |
| 4VO10RI1 | 328 | 518 | 808 | 98 |
| 4VO16RI1 | 363 | 388 | 713 | 98 |
| 4VO18RI1.5 | 403 | 444 | 809 | 98 |
| 4VO18RE1 | 363 | 686 | 1011 | 98 |
| 4VO21RE1 | 363 | 761 | 1086 | 98 |
| 4VO25RE1.5 | 403 | 861 | 1226 | 98 |
| 4VO/RJ/1007 | 328 | 434 | 724 | 98 |
| 4VO12RC1.5 | 403 | 525 | 890 | 98 |
| 4VO18RC2 | 468 | 686 | 1116 | 98 |
| 4VO8RJ1 | 368 | 462 | 789 | 98 |
| 4VO14RI1 | 363 | 332 | 657 | 98 |
| 4VO7BS1E | 435 | 435 | 397 | 98 |
| 4VO10AS1E | 395 | 475 | 832 | 98 |
| 4VO14AS1.5E | 435 | 585 | 982 | 98 |
| 4VO7RA1.5 | 403 | 1338 | 1703 | 98 |
| 4VO10RC1 | 363 | 475 | 800 | 98 |
| 4VO10RJ1.5 | 363 | 518 | 843 | 98 |
| 4VO14RC1.5 | 403 | 585 | 950 | 98 |
| 4VO8RP2 | 468 | 738 | 1168 | 98 |

4WSS Series Stainless Steel Borewell Submersible Pumps



High Grade Stainless Steel

Pure SS304 stainless steel construction resists corrosion and withstand tough operating conditions



Less Power Consumption

High operating efficiency results in high flow rate and low electricity bill



High Thrust Capacity

Specially designed thrust bearing ensures highest reliability



High Grade Electrical Stamping

Reduces electrical losses and improves pump efficiency



In Built Check Valve

In built check valve prevents pump parts from damage due to sudden back pressure



Easy for Maintenance

Simple construction, easily replaceable wear and tear parts

Technical Specifications:

- Range: 0.5 HP to 2.0 HP (0.37 kW to 1.5 kW)
- Rated voltage: 220V for 1PH & 415V for 3PH
- Voltage range: 180V - 240V for 1PH & 350V - 440V for 3PH
- Rated Frequency: 50Hz
- Delivery pipe size: 32 mm & 40 mm
- Max. Head: Upto 167 meter
- Max. Discharge: Upto 100 LPM
- Liquid: Clear water
- Motor type: Water filled motor

Application:

- Gardening
- Sprinkler irrigation
- Multistoried buildings
- Drip irrigation
- Construction sites



Performance Curve: 4WSS Series

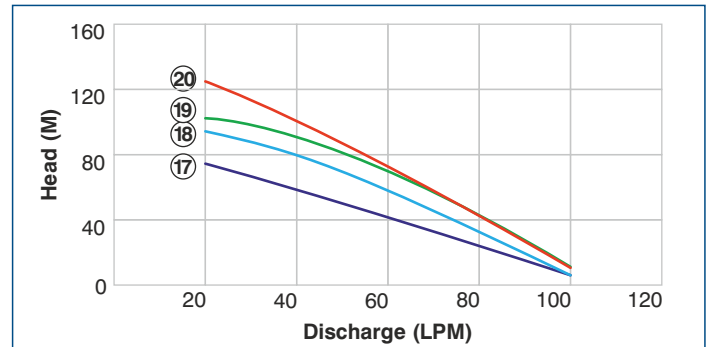
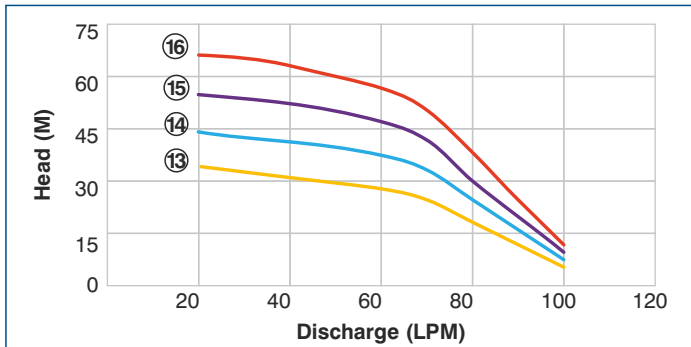
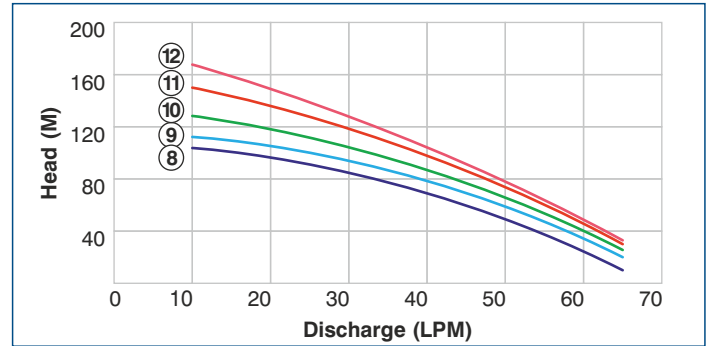
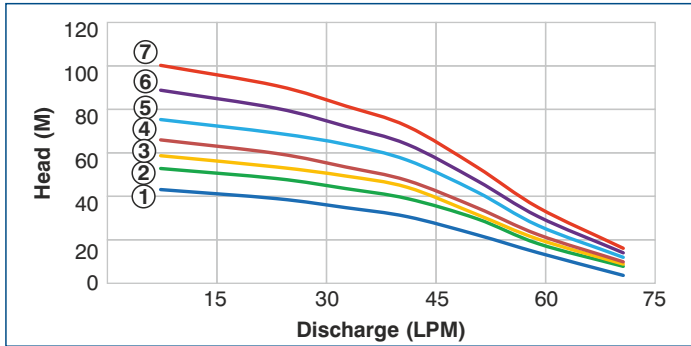

Performance Table: 4WSS Series

| Sr. No. | Rating | No. Of Stages | Motor | | Outlet Size mm | Discharge in LPM | | | | | | | Water Filled | | | |
|---------|-------------|---------------|-------|-----|----------------|------------------|----|----|----|----|----|----|---------------|---------|-----------------|---------------|
| | | | kW | HP | | 10 | 25 | 34 | 42 | 51 | 59 | 70 | Control Panel | MCB (A) | Start Cap (mfd) | Run Cap (mfd) |
| | | | | | | Head in Meter | | | | | | | | | | |
| *1 | 4WSSF3-0508 | 8 | 0.37 | 0.5 | 32 | 44 | 40 | 36 | 32 | 24 | 16 | 6 | NDCP0.5-BP | 6 | 80-100 | 36 |
| *2 | 4WSSF3-1010 | 10 | 0.75 | 1.0 | 32 | 53 | 49 | 44 | 40 | 31 | 20 | 10 | NDCP1-CQ | 10 | 100-120 | 50 |
| *3 | 4WSSF3-1011 | 11 | 0.75 | 1.0 | 32 | 59 | 54 | 50 | 45 | 33 | 22 | 11 | NDCP1-CQ | 10 | 100-120 | 50 |
| *4 | 4WSSF3-1013 | 13 | 0.75 | 1.0 | 32 | 66 | 60 | 54 | 48 | 36 | 24 | 12 | NDCP1-CQ | 10 | 100-120 | 50 |
| *5 | 4WSSF3-1014 | 14 | 0.75 | 1.0 | 32 | 75 | 69 | 64 | 57 | 43 | 28 | 14 | NDCP1-CQ | 10 | 100-120 | 50 |
| *6 | 4WSSF3-1016 | 16 | 0.75 | 1.0 | 32 | 88 | 80 | 72 | 64 | 48 | 32 | 16 | NDCP1-CQ | 10 | 100-120 | 50 |
| *7 | 4WSSF3-1018 | 18 | 0.75 | 1.0 | 32 | 99 | 90 | 81 | 72 | 54 | 36 | 18 | NDCP1-CQ | 10 | 100-120 | 50 |

| Sr. No. | Rating | No. Of Stages | Motor | | Outlet Size mm | Discharge in LPM | | | | | | | Water Filled | | | |
|---------|-------------|---------------|-------|-----|----------------|------------------|-----|-----|-----|----|----|----|---------------|---------|-----------------|---------------|
| | | | kW | HP | | 10 | 25 | 34 | 42 | 51 | 59 | 65 | Control Panel | MCB (A) | Start Cap (mfd) | Run Cap (mfd) |
| | | | | | | Head in Meter | | | | | | | | | | |
| *8 | 4WSSF3-1520 | 20 | 1.1 | 1.5 | 32 | 105 | 93 | 80 | 70 | 53 | 30 | 15 | NDCP1.5-DS | 13 | 120-150 | 72 |
| *9 | 4WSSF3-1522 | 22 | 1.1 | 1.5 | 32 | 115 | 102 | 90 | 80 | 55 | 35 | 20 | NDCP1.5-DS | 13 | 120-150 | 72 |
| *10 | 4WSSF3-1525 | 25 | 1.1 | 1.5 | 32 | 128 | 110 | 94 | 82 | 58 | 36 | 21 | NDCP1.5-DS | 13 | 120-150 | 72 |
| *11 | 4WSSF3-2028 | 28 | 1.5 | 2.0 | 32 | 150 | 132 | 115 | 103 | 75 | 45 | 25 | NDCP2-ET | 16 | 150-200 | 100 |
| *12 | 4WSSF3-2032 | 32 | 1.5 | 2.0 | 32 | 167 | 147 | 126 | 105 | 80 | 45 | 26 | NDCP2-ET | 16 | 150-200 | 100 |

| Sr. No. | Rating | No. Of Stages | Motor | | Outlet Size mm | Discharge in LPM | | | | | | | Water Filled | | | |
|---------|-------------|---------------|-------|-----|----------------|------------------|----|----|----|----|----|-----|---------------|---------|-----------------|---------------|
| | | | kW | HP | | 20 | 40 | 60 | 70 | 80 | 90 | 100 | Control Panel | MCB (A) | Start Cap (mfd) | Run Cap (mfd) |
| | | | | | | Head in Meter | | | | | | | | | | |
| *13 | 4WSSF5-0506 | 6 | 0.37 | 0.5 | 40 | 33 | 30 | 27 | 24 | 18 | 12 | 6 | NDCP0.5-BP | 6 | 80-100 | 36 |
| *14 | 4WSSF5-1008 | 8 | 0.75 | 1.0 | 40 | 44 | 40 | 36 | 32 | 24 | 16 | 8 | NDCP1-CQ | 10 | 100-120 | 50 |
| *15 | 4WSSF5-1010 | 10 | 0.75 | 1.0 | 40 | 55 | 50 | 45 | 40 | 30 | 20 | 10 | NDCP1-CQ | 10 | 100-120 | 50 |
| *16 | 4WSSF5-1012 | 12 | 0.75 | 1.0 | 40 | 66 | 60 | 54 | 48 | 36 | 24 | 12 | NDCP1-CQ | 10 | 100-120 | 50 |

| Sr. No. | Rating | No. Of Stages | Motor | | Outlet Size mm | Discharge in LPM | | | | | | | Water Filled | | | |
|---------|-------------|---------------|-------|-----|----------------|------------------|-----|----|----|----|----|-----|---------------|---------|-----------------|---------------|
| | | | kW | HP | | 20 | 40 | 60 | 70 | 80 | 90 | 100 | Control Panel | MCB (A) | Start Cap (mfd) | Run Cap (mfd) |
| | | | | | | Head in Meter | | | | | | | | | | |
| *17 | 4WSSF5-1515 | 15 | 1.1 | 1.5 | 40 | 75 | 65 | 53 | 45 | 35 | 20 | 9 | NDCP1.5-DS | 13 | 120-150 | 72 |
| *18 | 4WSSF5-1518 | 18 | 1.1 | 1.5 | 40 | 95 | 83 | 66 | 58 | 45 | 27 | 11 | NDCP1.5-DS | 13 | 120-150 | 72 |
| *19 | 4WSSF5-2020 | 20 | 1.5 | 2.0 | 40 | 101 | 90 | 72 | 62 | 47 | 31 | 14 | NDCP2-ET | 16 | 150-200 | 100 |
| *20 | 4WSSF5-2024 | 24 | 1.5 | 2.0 | 40 | 125 | 110 | 89 | 75 | 56 | 35 | 16 | NDCP2-ET | 16 | 150-200 | 100 |

Note :

1. The motor ratings in HP are only indicative and for reference purpose
2. Performance figures given above are approximate and may differ on site conditions

3. Performance mentioned on nameplate may vary as we are always improving our products
- 4 \$ Only Three phase
- 5 # Single phase and Three phase
- 6 *NRV & Suction Housing of Cast Iron

Material of Construction: 4WSS & 4CSS Series

| No. | Part | Material |
|-----|-----------------------------------|----------------------------------|
| 1 | Bowl | Stainless Steel SS304 |
| 2 | Impeller | Stainless Steel SS304 |
| 3 | Pump Shaft | Stainless Steel SS410/SS431 |
| 4 | NRV | Cast Iron/ Stainless Steel SS304 |
| 5 | Suction Housing | Cast Iron/ Stainless Steel SS304 |
| 6 | Motor Body | Stainless Steel SS202 |
| 7 | Upper & Lower Housing, Motor Base | Cast Iron-Grade FG 200 |
| 8 | Stamping | CRNGO (M47) |
| 9 | Bearing Bush | Bronze LTB-4 |
| 10 | Strainer | Stainless Steel SS202 |
| 11 | Sealing | Oil Seal |
| 12 | Thrust Bearing | Carbon Vs Stainless Steel |

Material of Construction: 4WSS & 4CSS Series

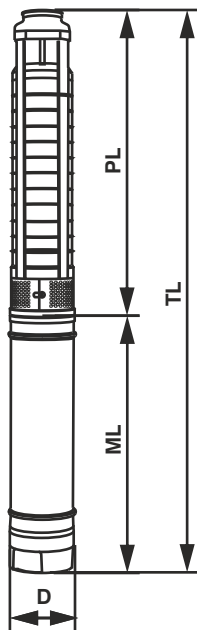

| All Dimensions are in mm | | | | |
|--------------------------|-----------|------|--------|----|
| Rating | ML | PL | TL | D |
| | Length mm | | | |
| | Motor | Pump | Total | |
| 4WSSF3-0508 | 367 | 379 | 708 | 98 |
| 4WSSF3-1010 | 377 | 424 | 763 | 98 |
| 4WSSF3-1011 | 377 | 447 | 786 | 98 |
| 4WSSF3-1013 | 392 | 493 | 847 | 98 |
| 4WSSF3-1014 | 412 | 515 | 889 | 98 |
| 4WSSF3-1016 | 452 | 561 | 975 | 98 |
| 4WSSF3-1018 | 452 | 607 | 1021 | 98 |
| 4WSSF3-1520 | 417 | 669 | 1045.5 | 98 |
| 4WSSF3-1522 | 437 | 714 | 1110.5 | 98 |
| 4WSSF3-1525 | 437 | 783 | 1179.5 | 98 |
| 4WSSF3-2028 | 487 | 851 | 1297.5 | 98 |
| 4WSSF3-2032 | 487 | 941 | 1387.5 | 98 |
| 4WSSF5-0506 | 367 | 334 | 663 | 98 |
| 4WSSF5-1008 | 377 | 379 | 718 | 98 |
| 4WSSF5-1010 | 392 | 424 | 778 | 98 |
| 4WSSF5-1012 | 412 | 470 | 844 | 98 |
| 4WSSF5-1515 | 417 | 506 | 882.5 | 98 |
| 4WSSF5-1518 | 457 | 574 | 990.5 | 98 |
| 4WSSF5-2020 | 457 | 669 | 1085.5 | 98 |
| 4WSSF5-2024 | 487 | 761 | 1207.5 | 98 |

Centrifugal Openwell Submersible Pumps (OW Series)



Less Power Consumption

High operating efficiency results in high flow rate and low electricity bill



High Thrust Capacity

Specially designed thrust bearing ensures highest reliability



Anti-Rust CED Coating*

Offers rust free and stuck free operation

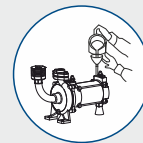

Prefilled with Coolant

Motor is prefilled with mixture of water & Glycol which prevents motor burning & gives excellent cooling effect



High Grade Electrical Stamping

Reduces electrical losses & improves pump efficiency



Easy for Maintenance

Simple construction, easily replaceable wear & tear parts

Technical Specifications:

- Range: 0.5HP to 2.0HP (0.37kW to 1.5kW)
- Rated voltage: 220V for 1 PH
- Voltage range: 160 -240V
- Rated Frequency: 50Hz
- Delivery pipe size: 25, 32, 40 & 50 mm
- Max. Head : Upto 75 meter
- Max. Discharge: Upto 520 LPM
- Motor type: Water filled motor

Application:

- Water transfer from underground tank to overhead tank
- Gardening & water fountains
- Domestic water supply in hotels, buildings & apartments



Performance Curve:

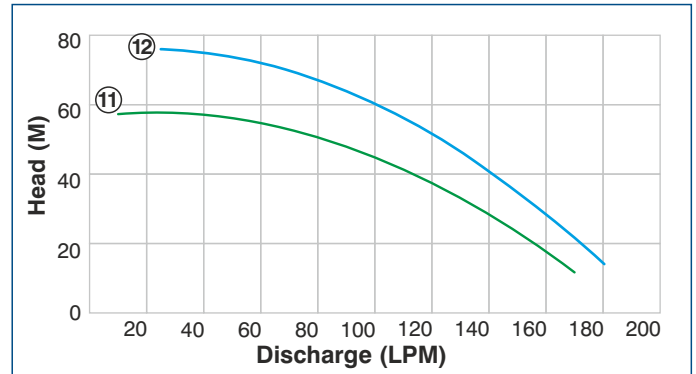
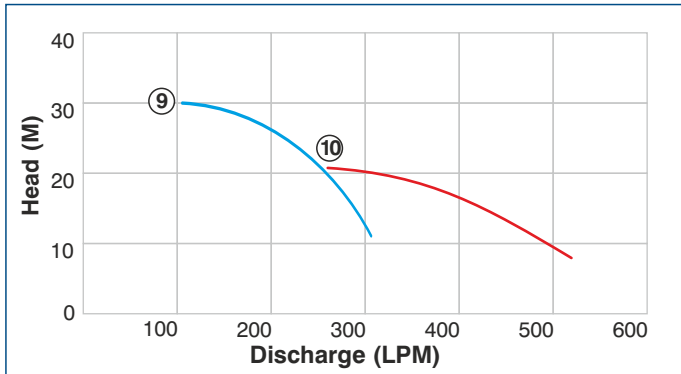
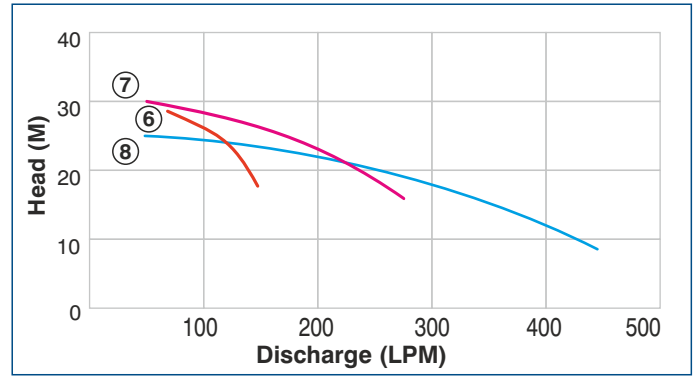
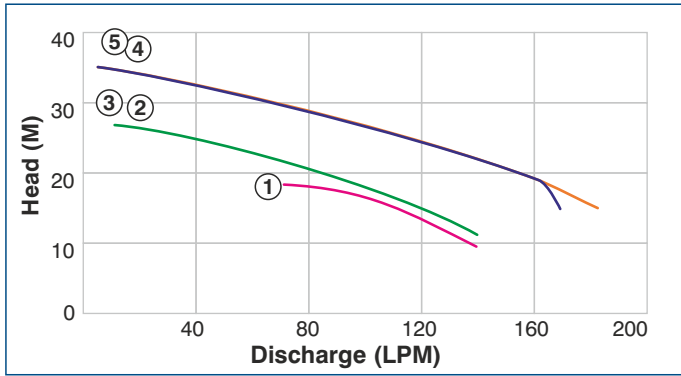

Performance Table:

| Sr. No. | Rating | Motor | | Outlet Size mm | Head in Meter | | | | | | | | |
|---------|-----------------|-------|-----|----------------|------------------|-----|-----|-----|-----|-----|----|----|----|
| | | kW | HP | | 9 | 12 | 15 | 18 | 21 | 24 | 27 | 30 | 34 |
| | | | | | Discharge in LPM | | | | | | | | |
| 1 | OWE052(1PH)Z-21 | 0.37 | 0.5 | 25 | 140 | 136 | 120 | 72 | | | | | |
| 2 | OWE12(1PH)Z-28 | 0.75 | 1.0 | 25 | - | 140 | 125 | 105 | 80 | 45 | 10 | - | - |
| 3 | OWE12(1PH)Z-28T | 0.75 | 1.0 | 25 | - | 140 | 125 | 105 | 80 | 45 | 10 | - | - |
| 4 | OWE12(1PH)Z-34 | 0.75 | 1.0 | 25 | - | - | 180 | 160 | 140 | 120 | 90 | 50 | 5 |
| 5 | OWE12(1PH)Z-34T | 0.75 | 1.0 | 25 | - | - | 165 | 160 | 140 | 120 | 90 | 50 | 5 |

| Sr. No. | Rating | Motor | | Outlet Size mm | Head in Meter | | | | | | | | |
|---------|------------------|-------|-----|----------------|------------------|-----|-----|-----|-----|-----|--------|-----|---|
| | | kW | HP | | 9 | 12 | 15 | 18 | 21 | 24 | 27 | 30 | |
| | | | | | Discharge in LPM | | | | | | | | |
| 6 | OWHE12-30(3PH) | 0.75 | 1.0 | 25 | - | - | - | 140 | 130 | 100 | 70 | - | - |
| *7 | OWG1.52(1PH)G-30 | 1.1 | 1.5 | 32 | - | - | 270 | 250 | 225 | 185 | 120 | 50 | - |
| *8 | OWK1.52(1PH)G-26 | 1.1 | 1.5 | 40 | 445 | 410 | 370 | 320 | 250 | 165 | 50@26M | - | - |
| *9 | OWK22(1PH)G-30 | 1.5 | 2.0 | 40 | - | 305 | 285 | 265 | 245 | 220 | 170 | 110 | - |
| *10 | OWM22(1PH)G-21 | 1.5 | 2.0 | 50 | 520 | 460 | 400 | 330 | 260 | - | - | - | - |

| Sr. No. | Rating | Motor | | No. Of Stage | Outlet Size mm | Head in Meter | | | | | | |
|---------|-------------|-------|-----|--------------|----------------|------------------|-----|-----|----|----|----|----|
| | | kW | HP | | | 11 | 38 | 40 | 47 | 53 | 56 | 58 |
| | | | | | | Discharge in LPM | | | | | | |
| 11 | OWHM1.52C9A | 1.1 | 1.5 | 9 | 40 | 170 | 125 | 115 | 90 | 60 | 40 | 10 |

| Sr. No. | Rating | Motor | | No. Of Stage | Outlet Size mm | Head in Meter | | | | | | |
|---------|------------|-------|-----|--------------|----------------|------------------|-----|-----|-----|----|----|----|
| | | kW | HP | | | 15 | 40 | 50 | 60 | 65 | 70 | 75 |
| | | | | | | Discharge in LPM | | | | | | |
| 12 | OWHM22C12A | 1.5 | 2.0 | 12 | 40 | 180 | 140 | 120 | 100 | 90 | 70 | 25 |

Note :

1. The motor ratings in HP are only indicative and for reference purpose
2. Performance figures given above are approximate and may differ on site conditions

3. Performance mentioned on nameplate may vary as we are always improving our products

4. * Models are with CED Coating and Mechanical Seal

Material of Construction:

| Sr. No. | Part | Material |
|---------|---------------------------------|-------------------------------------|
| 1 | End Shield (NDE)/ Lower Housing | Cast Iron-Grade FG 200 |
| 2 | Impeller | Cast Iron-Grade FG 200/Noryl/Delrin |
| 3 | Volute/Diffuser | Cast Iron-Grade FG 200/Noryl |
| 4 | Motor Body | Stainless Steel-SS202 |
| 5 | Adaptor / Upper Housing | Cast Iron-Grade FG 200 |
| 6 | Stamping Material | CRNGO-M47 |
| 7 | Motor Shaft | Stainless Steel-SS410 |
| 8 | DE/NDE Thrust Bearing | Carbon Vs SS on DE & NDE Side |
| 9 | Strainer | Stainless Steel-SS202 |
| 10 | Bearing Bush | Bronze LTB-4/Sintered carbon |
| 11 | Delivery Flange | Cast Iron-Grade FG 200 |
| 12 | Fasteners | Stainless Steel-SS202 |

Pump Dimensional Details:

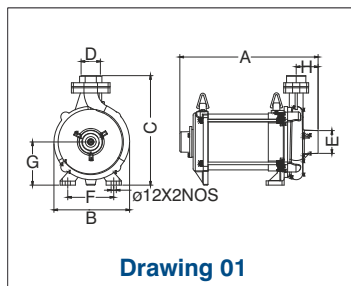

Drawing 01

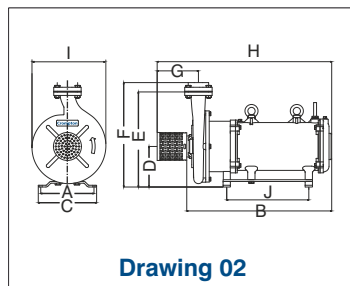

Drawing 02

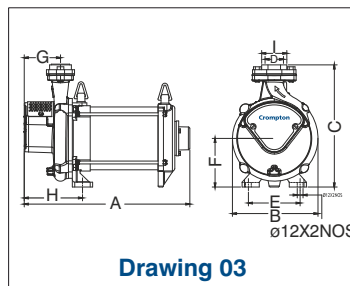

Drawing 03

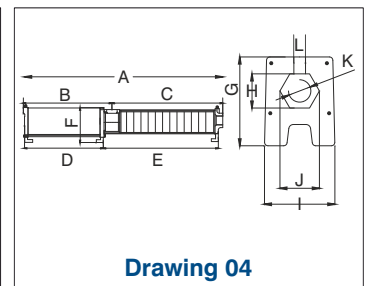

Drawing 04

Refer Drawing 01

| Model Name | Pipe Size mm | All Dimensions are in mm | | | | | | | |
|-----------------|--------------|--------------------------|-----|-----|----|----|-----|-----|----|
| | | A | B | C | D | E | F | G | H |
| OWE052(1PH)Z-21 | 32X25 | 325 | 150 | 230 | 25 | 32 | 107 | 82 | 62 |
| OWE12(1PH)Z-28 | 32X25 | 323 | 173 | 255 | 25 | 32 | 107 | 100 | 51 |
| OWE12(1PH)Z-34 | 32X25 | 325 | 175 | 255 | 25 | 32 | 107 | 100 | 51 |

Refer Drawing 02

| Model Name | Pipe Size mm | All Dimensions are in mm | | | | | | | | | |
|------------------|--------------|--------------------------|-----|-----|-----|-----|-----|-----|-----|-----|-----|
| | | A | B | C | D | E | F | G | H | I | J |
| OWHE12-30 | 32X25 | 138 | 310 | 150 | 120 | 250 | 282 | 96 | 370 | 191 | - |
| OWG1.52(1PH)G-30 | 40X32 | 135 | 452 | 162 | 135 | 280 | 310 | 149 | 509 | 204 | 195 |
| OWK1.52(1PH)G-26 | 50X40 | 135 | 452 | 162 | 135 | 280 | 310 | 149 | 509 | 204 | 195 |
| OWK22(1PH)G-30 | 50X40 | 135 | 437 | 162 | 135 | 255 | 285 | 134 | 509 | 204 | 195 |
| OWM22(1PH)G-21 | 50X50 | 135 | 437 | 162 | 135 | 255 | 285 | 134 | 509 | 204 | 195 |

Refer Drawing 03

| Model Name | Pipe Size mm | All Dimensions are in mm | | | | | | | | |
|-----------------|--------------|--------------------------|-----|-----|----|-----|-----|----|-----|-----|
| | | A | B | C | D | E | F | G | H | I |
| OWE12(1PH)Z-28T | 32x25 | 347 | 175 | 255 | 25 | 107 | 100 | 79 | 127 | ø44 |
| OWE12(1PH)Z-34T | 32x25 | 352 | 175 | 255 | 25 | 107 | 100 | 79 | 127 | ø44 |

Refer Drawing 04

| Model Name | Pipe Size mm | All Dimensions are in mm | | | | | | | | | | | |
|-------------|--------------|--------------------------|-----|-----|-----|-----|-----|-----|----|--------|----|----|------|
| | | A | B | C | D | E | F | G | H | I | J | K | L |
| OWHM1.52C9A | 40x40 | 782 | 377 | 405 | 313 | 445 | 142 | 143 | 65 | 101.50 | 75 | 45 | 27.5 |
| OWHM22C12A | 40x40 | 910 | 385 | 507 | 331 | 550 | 150 | 143 | 65 | 101.50 | 75 | 45 | 27.5 |

Compressor Pumps



Cast Iron Motor Body and Cylinder

Ensures constructional ruggedness for long lasting consistent performance



Aluminium Alloy Piston

High Strength, light weight and less wear due to high rate of heat conductivity

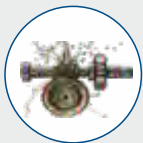

Splash Lubrication

Ensure regular lubrication and reduces frictional losses



High Grade Electrical Stamping

Reduces electrical losses & improves pump efficiency

Technical Specifications:

- Range: 1HP to 1.5HP (0.75kW to 1.1kW)
- Rated voltage: 220V for 1PH
- Delivery pipe size: 25 mm
- Voltage range: 160 -240V
- Rated Frequency: 50Hz
- Max. Head : Upto 400 feet
- Max. Discharge: Upto 4200 LPH

Application:

- Multi storied buildings
- Supply in hotels, buildings & apartments
- Water transfer from underground to overhead tank
- Water lifting from borewell having feculent yeilds, muddy water

Performance Curve:

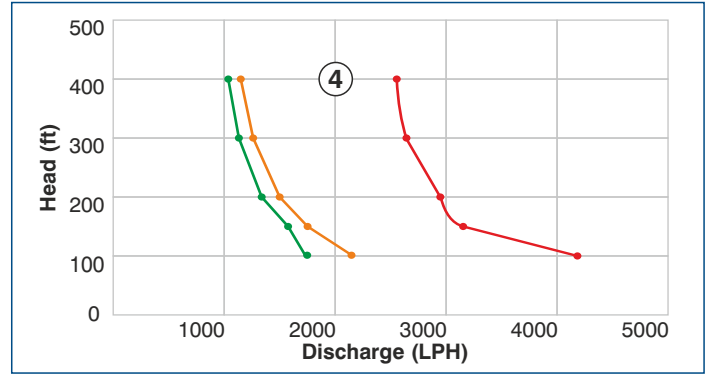
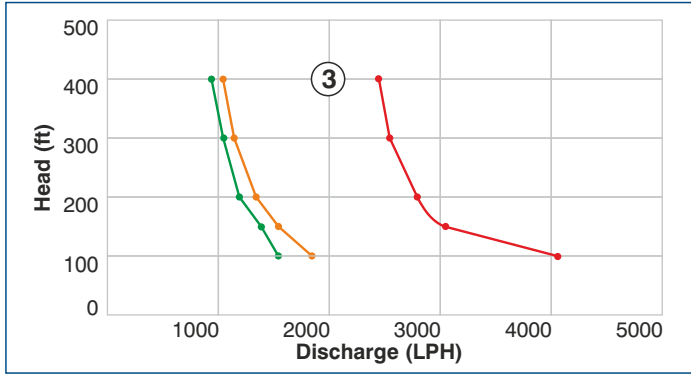
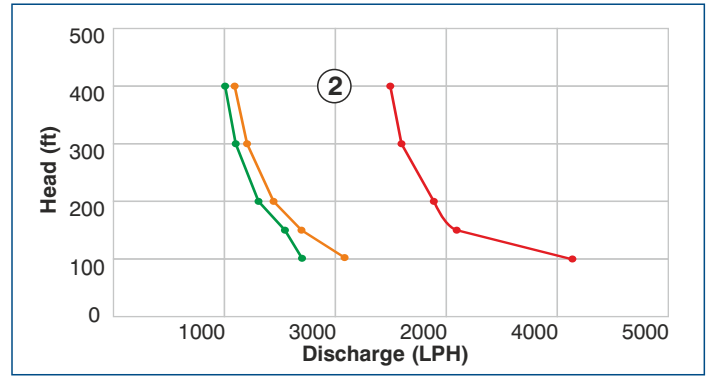
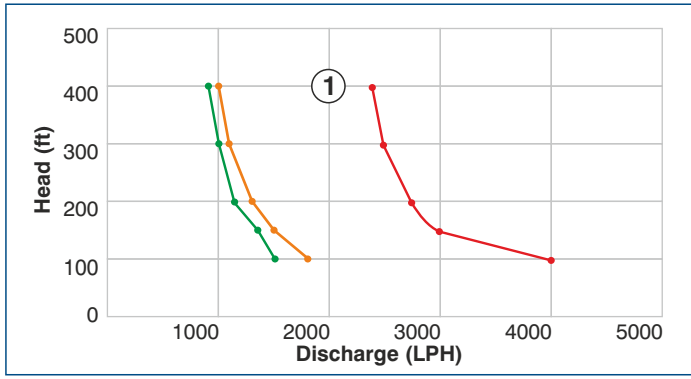

● At pumping height (25%)

● At pumping height (50%)

● At pumping height (75%)

Performance Table:

| Sr. No. | Rating | Motor | | No. of Cylinder | Compressor RPM | Pressure Kg/cm ² | Belt size CP | Inlet Pipe mm | Outlet Pipe mm | Jet Pipe mm |
|---------|-------------|-------|-----|-----------------|----------------|-----------------------------|--------------|---------------|----------------|-------------|
| | | kW | HP | | | | | | | |
| 1 | CP1-J400 | 0.75 | 1.0 | 1 | 1170 | 7 | - | 12 | 25 | 25 |
| 2 | CP1.5-J400 | 1.1 | 1.5 | 1 | 905 | 7 | - | 12 | 25 | 25 |
| 3 | MCP1-J400 | 0.75 | 1.0 | 1 | 1450 | 9 | B-37 | 12 | 25 | 25 |
| 4 | MCP1.5-J400 | 1.1 | 1.5 | 1 | 1450 | 9 | B-38 | 12 | 25 | 25 |

| Sr. No. | Rating | Motor | | Pumping Height* | Lifting Height | Head in Feet | | | | |
|---------|-------------|-------|-----|-----------------|----------------|------------------|------|------|------|------|
| | | kW | HP | | | 100 | 150 | 200 | 300 | 400 |
| | | | | | | Discharge in LPH | | | | |
| 1 | CP1-J400 | 0.75 | 1.0 | 25% | 75% | 1500 | 1350 | 1150 | 1000 | 900 |
| | | | | 50% | 50% | 1800 | 1500 | 1300 | 1100 | 1000 |
| | | | | 75% | 25% | 4000 | 3000 | 2750 | 2500 | 2400 |
| 2 | CP1.5-J400 | 1.1 | 1.5 | 25% | 75% | 1700 | 1550 | 1300 | 1100 | 1000 |
| | | | | 50% | 50% | 2100 | 1700 | 1450 | 1200 | 1100 |
| | | | | 75% | 25% | 4150 | 3100 | 2900 | 2600 | 2500 |
| 3 | MCP1-J400 | 0.75 | 1.0 | 25% | 75% | 1550 | 1400 | 1200 | 1050 | 950 |
| | | | | 50% | 50% | 1850 | 1550 | 1350 | 1150 | 1050 |
| | | | | 75% | 25% | 4050 | 3050 | 2800 | 2550 | 2450 |
| 4 | MCP1.5-J400 | 1.1 | 1.5 | 25% | 75% | 1750 | 1600 | 1350 | 1150 | 1050 |
| | | | | 50% | 50% | 2150 | 1750 | 1500 | 1250 | 1150 |
| | | | | 75% | 25% | 4200 | 3150 | 2950 | 2650 | 2550 |

Note :

- The motor ratings in HP are only indicative and for reference purpose
- Performance figures given above are approximate and may differ on site conditions

- Performance mentioned on nameplate may vary as we are always improving our products

Single Phase Control Panels Crompton ARMOR Series



Dry Run Protection

Protects pump from running in dry condition



Wide Voltage Application

Works effectively in wide voltage range from 120V – 260V for single phase.



Overload Protection

Protects pump from running in overload condition



Settable OFF-Timer

Settable off timer from 10 mins- 720 mins makes the pump OFF operation automatic



Under Voltage Protection

Protects pump from running in Under voltage condition.



Over Voltage Protection

Protects pump from running in over voltage condition.

Technical Specifications:

- HP Range: 0.5 HP to 2.0 HP (0.37 kW to 1.5 kW)
- Rated Voltage: 220V
- Voltage Range: 120V-260V
- Rated Frequency: 50Hz
- Connection Strip: 5-way 30A

Application:

- Suitable for Crompton's single-phase Water filled 3W/4W/4WSS submersible pump set ranging from 0.37/0.5 kW/HP to 1.5/2.0 kW/HP



PUMP + ARMOR PANEL 6 MONTHS ADDITIONAL WARRANTY

V3 / V4 SUBMERSIBLE PUMP + ARMOR CONTROL PANEL = 6 Months Additional

*Terms & Conditions - Buy pump and Armor panel in single invoice to get additional 6 months warranty

Crompton ARMOR Series (Suitable for 3W/4W/4WSS Single Phase Water Filled Submersible Pump Set)

| Model Name | Motor | | FLC | Start Capacitor | Run Capacitor | HRC Fuse |
|---------------|-------|------|--------|-----------------|---------------|----------|
| | kW | HP | | | | |
| ARMOR0.5-BPU | 0.37 | 0.50 | 5.3 A | 80-100 MFD | 36 MFD | 25 |
| ARMOR0.75-BQU | 0.55 | 0.75 | 6.2 A | 80-100 MFD | 50 MFD | 32 |
| ARMOR1-CQU | 0.75 | 1.0 | 7.5 A | 100-120 MFD | 50 MFD | 35 |
| ARMOR1.5-DSU | 1.1 | 1.5 | 10.5 A | 120-150 MFD | 72 MFD | 50 |
| ARMOR2-ETU | 1.5 | 2.0 | 13.8 A | 150-200 MFD | 100 MFD | 63 |

Dimensional Details:

| Sr. No. | Model Name | Dimensions Details(mm) | | | Weight Details(Kg) | |
|---------|--------------|------------------------|-----|-----|--------------------|-----------|
| | | L | B | H | Net wt. | Gross wt. |
| 1 | ARMOR Series | 242 | 102 | 197 | 2.19 | 2.45 |

Capacitor Logic:

| Start Capacitor Micro Farad | Denotation | Run Capacitor Micro Farad | Denotation |
|-----------------------------|------------|---------------------------|------------|
| 60/80 | A | 45 | H |
| 80/100 | B | 30 | I |
| 100/120 | C | 60 | J |
| 120/150 | D | 20 | K |
| 150/200 | E | 40 | L |
| 200/250 | F | 25 | M |
| 40/60 | Z | 36 | P |
| | | 50 | Q |
| | | 65 | R |
| No capacitor | N | 72 | S |
| | | 100 | T |
| | | 108 | U |
| | | 144 | V |
| | | 80 | W |

Example:

| ARMOR 1.0-CQU | | | |
|--------------------------------|----|------------------------------|----------------------|
| ARMOR | 1 | C | Q |
| SUITABLE FOR WATER FILLED PUMP | HP | START CAPACITOR(100-120 MFD) | RUN CAPACITOR(50MFD) |

Single Phase Control Panels (NDCP/CDCP & NODCP/CODCP Series)



Overload Protection

Ensures pump protection by tripping MCB/OLP when current exceeds its limit



Special Contactor

Heavy duty contactor specially designed for handling higher voltage fluctuations and operating current

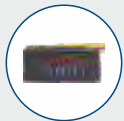

Current & Voltage Display

Robust designed VA Meter shows Current & Voltage upto 30A & 300V accurately.



Specially Designed Capacitor

Crompton Pump specific start & run capacitor ensures high starting torque and reliable



Wide Voltage Application

Designed to withstand wide voltage fluctuations range from 160V – 260V



Easy for Maintenance

Easily replaceable wear & tear Parts

Technical Specifications:

- Range: -0.5 HP to 3.0 HP (0.37 kW to 2.2 kW)
- Rated Voltage: - 220V
- Voltage Range: - 160V-260V
- Frequency: 50 Hz
- Connection Strip: 5-Way 30A

Application:

- Suitable for Crompton Single-Phase water filled 3W/4W/4WSS/4CSS submersible pump (NDCP/CDCP Series)
- Suitable for Crompton Single-Phase Oil filled 3VO/4VO/4VOSS submersible pump (NODCP/CODCP Series)

NDCP/CDCP Series (Suitable for 3W/4W/4WSS Series Single Phase Water Filled Submersible Pump Set)

| Model Name | Motor | | FLC | Start Capacitor | Run Capacitor | MCB | HRC Fuse |
|---------------|-------|------|--------|-----------------|---------------|---------|----------|
| | kW | HP | | | | | |
| NDCP0.5-BP | 0.37 | 0.50 | 5.3 A | 80-100 MFD | 36 MFD | 6 A SP | 25 |
| CDCP0.5-BPT# | | | 5.3 A | 80-100 MFD | 36 MFD | 6 A SP | 25 |
| NDCP0.75-BQ | 0.55 | 0.75 | 6.2 A | 80-100 MFD | 50 MFD | 8 A SP | 32 |
| CDCP0.75-BQT# | | | 6.2 A | 80-100 MFD | 50 MFD | 8 A SP | 32 |
| NDCP1-CQ | 0.75 | 1.00 | 7.5 A | 100-120 MFD | 50 MFD | 10 A SP | 35 |
| CDCP1-CQT# | | | 7.5 A | 100-120 MFD | 50 MFD | 10 A SP | 35 |
| NDCP1.5-DS | 1.10 | 1.50 | 10.5 A | 120-150 MFD | 72 MFD | 13 A SP | 50 |
| CDCP1.5-DST# | | | 10.5 A | 120-150 MFD | 72 MFD | 13 A SP | 50 |
| NDCP2-ET | 1.50 | 2.00 | 13.8 A | 150-200 MFD | 100 MFD | 16 A SP | 63 |
| CDCP2-ETT# | | | 13.8 A | 150-200 MFD | 100 MFD | 16 A SP | 63 |
| NDCP3-FU | 2.20 | 3.00 | 19.8 A | 200-250 MFD | 108 MFD | 25 A SP | 100 |
| CDCP3-FUT# | | | 19.8 A | 200-250 MFD | 108 MFD | 25 A SP | 100 |

Note: # Marked models have 1-Pole Contactor

NDCP Series (Suitable for 4CSS Series Single Phase Water Filled Submersible Pump Set)

| Model Name | Motor | | FLC | Start Capacitor | Run Capacitor | MCB | HRC Fuse |
|---------------|-------|------|--------|-----------------|---------------|---------|----------|
| | kW | HP | | | | | |
| NDCP0.5SS-BP | 0.37 | 0.5 | 5.3 A | 80-100 MFD | 36 MFD | 6 A SP | 25 |
| NDCP0.75SS-BP | 0.55 | 0.75 | 6.2 A | 80-100 MFD | 36 MFD | 8 A SP | 32 |
| NDCP1SS-CP | 0.75 | 1.0 | 7.5 A | 100-120 MFD | 36 MFD | 10 A SP | 35 |
| NDCP1.5SS-DQ | 1.1 | 1.5 | 10.5 A | 120-150 MFD | 50 MFD | 13 A SP | 50 |
| NDCP2SS-ES | 1.5 | 2.0 | 13.8 A | 150-200 MFD | 72 MFD | 16 A SP | 63 |
| NDCP3SS-FT | 2.2 | 3.0 | 19.8 A | 200-250 MFD | 100 MFD | 25 A SP | 100 |

Dimensional Details:

| Sr. No. | Model Name | Dimensions Details(mm) | | | Weight Details(Kg) | |
|---------|------------------|------------------------|-----|-----|--------------------|-----------|
| | | L | B | H | Net wt. | Gross wt. |
| 1 | NDCP/CDCP Series | 242 | 132 | 105 | 2.15 | 2.5 |

NODCP/CODCP Series (Suitable For Fully 3VO/4VO Single Phase Oil Filled Submersible Pump Set)

| Model Name | Motor | | FLC | Start Capacitor | Run Capacitor | OLP/MCB | HRC Fuse |
|---------------|-------|------|--------|-----------------|---------------|---------|----------|
| | kW | HP | | | | | |
| NODCP0.5-NM | 0.37 | 0.5 | 4.1 A | NA | 25 MFD | 5 A | 20 |
| CODCP0.5-ZM* | | | 4.1 A | 40-60 MFD | 25 MFD | 6 A | 20 |
| NODCP0.75-NP | 0.55 | 0.75 | 5 A | NA | 36 MFD | 6 A | 25 |
| CODCP0.75-ZP* | | | 5 A | 40-60 MFD | 36 MFD | 6 A | 25 |
| NODCP1-NP | 0.75 | 1.0 | 6.7 A | NA | 36 MFD | 8 A | 32 |
| CODCP1-ZP* | | | 6.7 A | 40-60 MFD | 36 MFD | 8 A | 32 |
| NODCP1.5-NP | 1.1 | 1.5 | 9.5 A | NA | 36 MFD | 12 A | 50 |
| CODCP1.5-ZP* | | | 9.5 A | 40-60 MFD | 36 MFD | 13 A | 50 |
| NODCP2-NP | 1.5 | 2.0 | 12.5 A | NA | 36 MFD | 15 A | 63 |
| CODCP2-ZP* | | | 12.5 A | 40-60 MFD | 36 MFD | 16 A | 63 |
| NODCP3-NS | 2.2 | 3.0 | 16 A | NA | 72 MFD | 25 A | 80 |
| CODCP3-ZS* | | | 16 A | 40-60 MFD | 72 MFD | 25 A | 80 |

Note: - * Marked models have MCB and Start Capacitor instead of OLP & Contactor.

Dimensional Details:

| Sr. No. | Model Name | Dimensions Details(mm) | | | Weight Details(Kg) | |
|---------|--------------|------------------------|-----|-----|--------------------|-----------|
| | | L | B | H | Net wt. | Gross wt. |
| 1 | NODCP Series | 242 | 132 | 105 | 2.15 | 2.5 |
| 2 | CODCP Series | 235 | 132 | 78 | 1.38 | 1.70 |

Capacitor Logic:

| Start Capacitor Micro Farad | Denotation | Run Capacitor Micro Farad | Denotation |
|-----------------------------|------------|---------------------------|------------|
| 60/80 | A | 45 | H |
| 80/100 | B | 30 | I |
| 100/120 | C | 60 | J |
| 120/150 | D | 20 | K |
| 150/200 | E | 40 | L |
| 200/250 | F | 25 | M |
| 40/60 | Z | 36 | P |
| | | 50 | Q |
| | | 65 | R |
| No capacitor | N | 72 | S |
| | | 100 | T |
| | | 108 | U |
| | | 144 | V |
| | | 80 | W |

Example:

| | | | | |
|---------------------------------|---------------------------|----------|--|-----------------------|
| NDCP1-CQ/ CDCP1-CQ | NDCP/CDCP | 1 | C | Q |
| | Suitable For Water Filled | HP | Start Capacitor (100-120 MFD) | Run Capacitor (50MFD) |
| NODCP1-NP/ CODCP1-ZP | NODCP/CODCP | 1 | N/Z | P |
| | Suitable For Oil Filled | HP | No Capacitor/Start Capacitor (40-60 MFD) | Run Capacitor (36MFD) |

Crompton

Less electricity, more water Make farming better

AGRICULTURAL PUMPS EXPLORER



4W Series Borewell Submersible Pumps



High Grade Electrical Stampings

Reduced Electrical losses lowers the operating current of the pump



In Built Check Valve

In built check valve prevents pump parts from damage due to sudden back pressure



Lower Operating Current

Robust Electrical Design Ensures Lower Electrical Current and Lower Power Bill



High Thrust Capacity

Specially designed thrust bearing ensures highest reliability



Easy For Maintenance

Easily replaceable wear & tear Parts, Low maintenance cost

Technical Specifications:

- Range: 3.0HP to 5.0HP (2.2kW to 3.7kW)
- Rated voltage: 220V for 1PH & 415V for 3PH
- Voltage range: 180V - 240V for 1PH & 350V - 440V for 3PH
- Rated Frequency: 50Hz
- Delivery pipe size: 32mm to 65mm
- Max. Head: Upto 296 meter
- Max. Discharge: Upto 500LPM
- Liquid: Clear water
- Motor type: Water filled motor

Application:

- Sprinkler irrigation
- Drip irrigation
- Agricultural farms
- Multistoried Buildings
- Construction sites
- Water supply for Industrial / Commercial Establishment
- Gardening



Performance Curve:

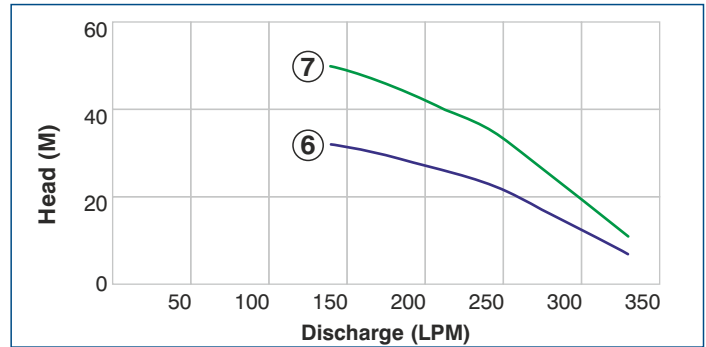
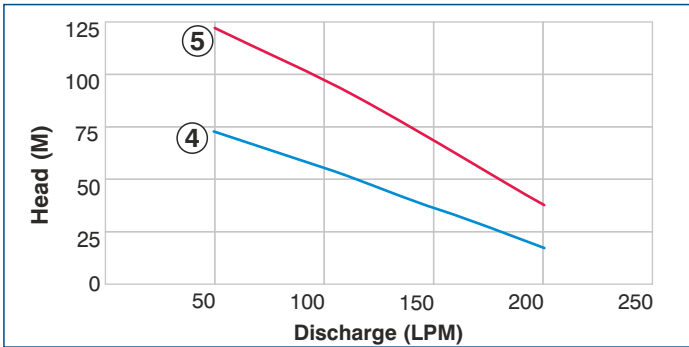
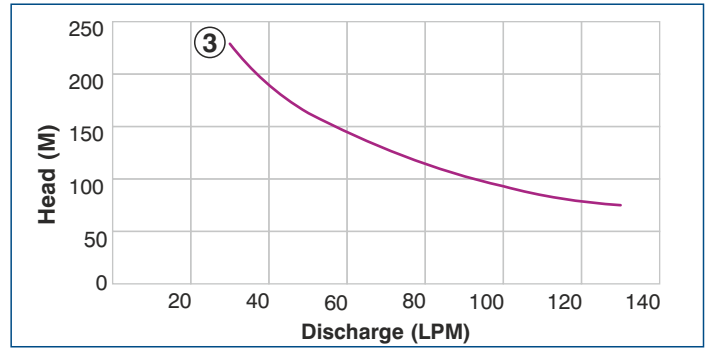
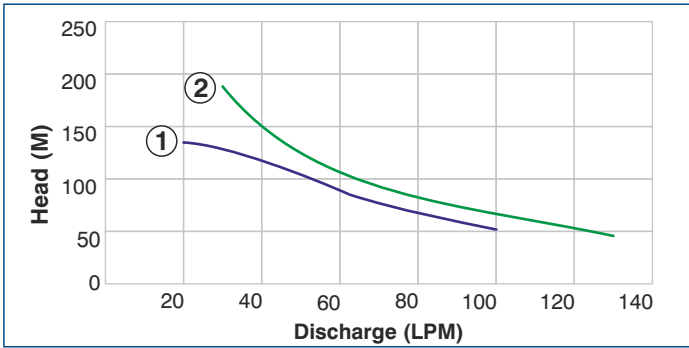

Performance Table:

| Sr. No. | Rating | No. Of Stages | Motor | | Outlet Size mm | Discharge in LPM | | | | | | |
|---------|--------------------------|---------------|-------|----|----------------|------------------|-----|-----|-----|-----|-----|-----|
| | | | kW | HP | | 20 | 30 | 50 | 60 | 90 | 100 | 130 |
| | | | | | | Head in Meter | | | | | | |
| 1 | 4W17B3J-VX | 17 | 2.2 | 3 | 40 | 129 | 122 | 108 | 79 | 67 | 52 | - |
| 2 | 4W17D3J-VX/ 4W17D3TPJ-VX | 17 | 2.2 | 3 | 40 | - | 184 | 98 | 84 | 79 | 67 | 47 |
| 3 | 4W30D5TPJ-VX | 30 | 3.7 | 5 | 40 | - | 245 | 162 | 150 | 132 | 98 | 78 |

| Sr. No. | Rating | No. Of Stages | Motor | | Outlet Size mm | Discharge in LPM | | | | |
|---------|--------------------------|---------------|-------|----|----------------|------------------|-----|-----|-----|-----|
| | | | kW | HP | | 50 | 110 | 140 | 170 | 200 |
| | | | | | | Head in Meter | | | | |
| 4 | 4W15E3J-VX/ 4W15E3TPJ-VX | 15 | 2.2 | 3 | 50 | 74 | 54 | 42 | 32 | 20 |
| 5 | 4W25E5TPJ-VX | 25 | 3.7 | 5 | 50 | 123 | 91 | 72 | 53 | 33 |

| Sr. No. | Rating | No. Of Stages | Motor | | Outlet Size mm | Discharge in LPM | | | | | |
|---------|-------------------------|---------------|-------|----|----------------|------------------|-----|-----|-----|-----|-----|
| | | | kW | HP | | 140 | 170 | 200 | 240 | 270 | 330 |
| | | | | | | Head in Meter | | | | | |
| 6 | 4W7F3J-VX / 4W7F3TPJ-VX | 7 | 2.2 | 3 | 50 | 32 | 30 | 27 | 23 | 18 | 7 |
| 7 | 4W12F5TPJ-VX | 12 | 3.7 | 5 | 50 | 50 | 47 | 42 | 36 | 28 | 11 |

Performance Curve:

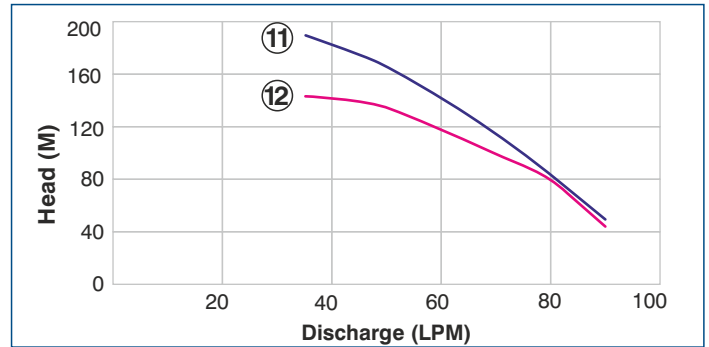
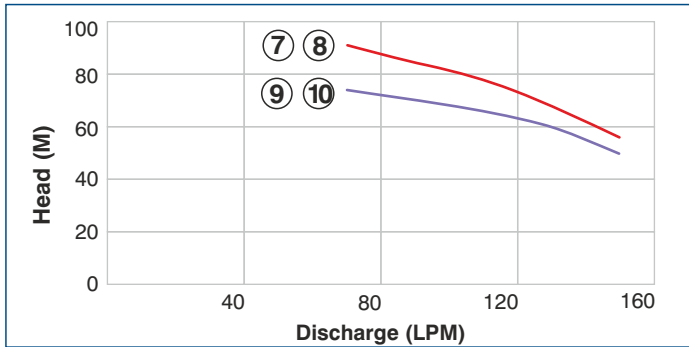
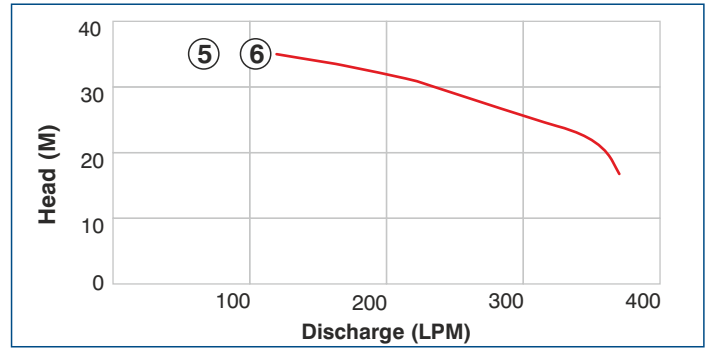
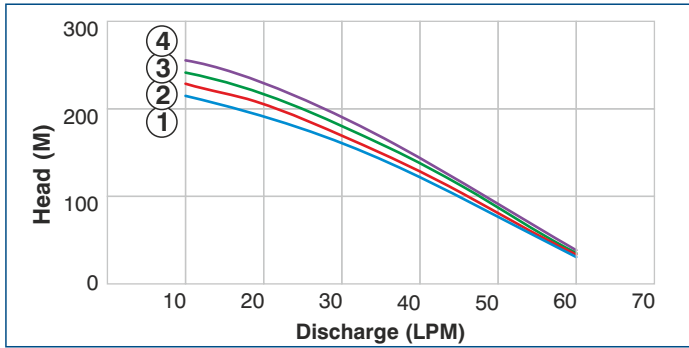

Performance Table:

| Sr. No. | Rating | No. Of Stages | Motor | | Outlet Size mm | Discharge in LPM | | | | | |
|---------|----------|---------------|-------|----|----------------|------------------|-----|-----|-----|----|----|
| | | | kW | HP | | 10 | 20 | 30 | 40 | 50 | 60 |
| | | | | | | Head in Meter | | | | | |
| 1 | 4W32AL3D | 32 | 2.2 | 3 | 32 | 215 | 194 | 160 | 123 | 78 | 32 |
| 2 | 4W34AL3D | 34 | 2.2 | 3 | 32 | 229 | 206 | 170 | 130 | 83 | 34 |
| 3 | 4W36AL3D | 36 | 2.2 | 3 | 32 | 242 | 218 | 180 | 138 | 88 | 36 |
| 4 | 4W38AL3D | 38 | 2.2 | 3 | 32 | 255 | 230 | 190 | 146 | 93 | 38 |

| Sr. No. | Rating | No. Of Stages | Motor | | Outlet Size mm | Discharge in LPM | | | | |
|---------|------------------------|---------------|-------|----|----------------|------------------|-----|-----|-----|-----|
| | | | kW | HP | | 120 | 200 | 250 | 350 | 370 |
| | | | | | | Head in Meter | | | | |
| 5 | 4W7BJ3D/4W7BJ3D-65 | 7 | 2.2 | 3 | 50/65 | 35 | 32 | 29 | 22 | 17 |
| 6 | 4W7BJ3DTP/4W7BJ3DTP-65 | 7 | 2.2 | 3 | 50/65 | 35 | 32 | 29 | 22 | 17 |

| Sr. No. | Rating | No. Of Stages | Motor | | Outlet Size mm | Discharge in LPM | | | | |
|---------|--------------------------|---------------|-------|----|----------------|------------------|----|-----|-----|-----|
| | | | kW | HP | | 70 | 85 | 110 | 130 | 150 |
| | | | | | | Head in Meter | | | | |
| 7 | 4W15BG3D/4W15BG3D-50 | 15 | 2.2 | 3 | 40/50 | 91 | 86 | 78 | 68 | 56 |
| 8 | 4W15BG3DTP/4W15BG3DTP-50 | 15 | 2.2 | 3 | 40/50 | 91 | 86 | 78 | 68 | 56 |
| 9 | 4W12BG3D/4W12BG3D-50 | 12 | 2.2 | 3 | 40/50 | 74 | 71 | 66 | 60 | 50 |
| 10 | 4W12BG3DTP/4W12BG3DTP-50 | 12 | 2.2 | 3 | 40/50 | 74 | 71 | 66 | 60 | 50 |

| Sr. No. | Rating | No. Of Stages | Motor | | Outlet Size mm | Discharge in LPM | | | | |
|---------|---------------------|---------------|-------|----|----------------|------------------|-----|-----|----|----|
| | | | kW | HP | | 35 | 50 | 70 | 80 | 90 |
| | | | | | | Head in Meter | | | | |
| 11 | 4W30BH3DTP | 30 | 2.2 | 3 | 32 | 190 | 166 | 115 | 84 | 50 |
| 12 | 4W21BH3D/4W21BH3DTP | 21 | 2.2 | 3 | 32 | 144 | 135 | 100 | 80 | 45 |

Performance Curve:

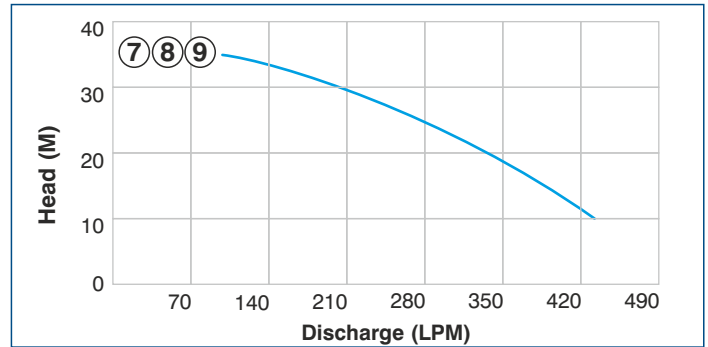
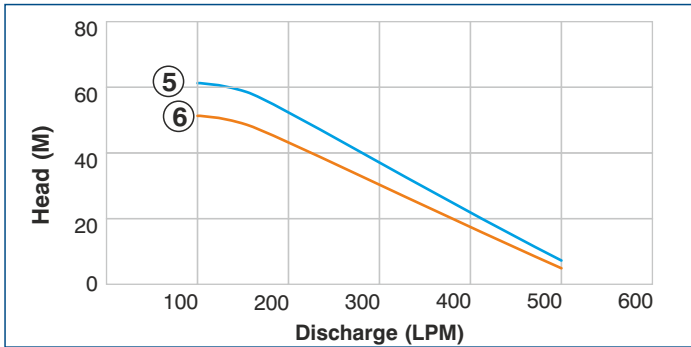
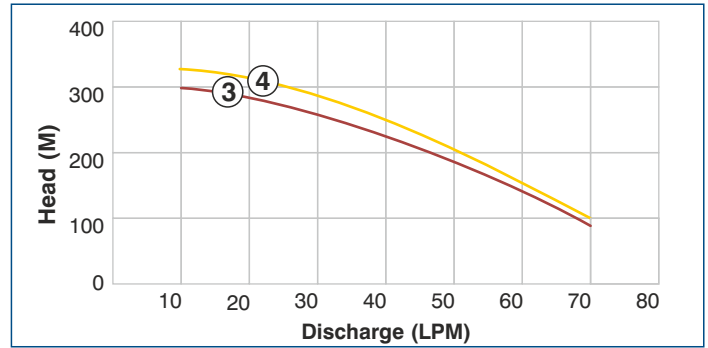
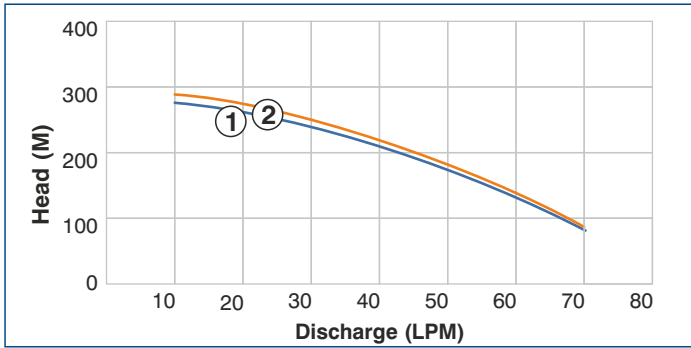

Performance Table:

| Sr. No. | Rating | No. Of Stages | Motor | | Outlet Size mm | Discharge in LPM | | | | | | |
|---------|------------|---------------|-------|-----|----------------|------------------|-----|-----|-----|-----|-----|-----|
| | | | kW | HP | | 10 | 20 | 30 | 40 | 50 | 60 | 70 |
| | | | | | | Head in Meter | | | | | | |
| 1 | 4W42AK5DTP | 42 | 3.7 | 5.0 | 32 | 277 | 264 | 240 | 210 | 172 | 133 | 84 |
| 2 | 4W44AK5DTP | 44 | 3.7 | 5.0 | 32 | 290 | 277 | 252 | 220 | 180 | 139 | 88 |
| 3 | 4W45AK5DTP | 45 | 3.7 | 5.0 | 32 | 297 | 283 | 257 | 225 | 184 | 142 | 90 |
| 4 | 4W50AK5DTP | 50 | 3.7 | 5.0 | 32 | 330 | 315 | 286 | 250 | 205 | 158 | 100 |

| Sr. No. | Rating | No. Of Stages | Motor | | Outlet Size mm | Discharge in LPM | | |
|---------|------------------------------|---------------|-------|-----|----------------|------------------|-----|-----|
| | | | kW | HP | | 100 | 150 | 500 |
| | | | | | | Head in Meter | | |
| 5 | 4W12BR5DTP-65/4W12BR5D(I)-65 | 12 | 3.7 | 5.0 | 65 | 61 | 59 | 7 |
| 6 | 4W10BR5DTP-65/4W10BR5D(I)-65 | 10 | 3.7 | 5.0 | 65 | 51 | 49 | 5 |

| Sr. No. | Rating | No. Of Stages | Motor | | Outlet Size mm | Discharge in LPM | | | | | | | |
|---------|---------------|---------------|-------|-----|----------------|------------------|-----|-----|-----|-----|-----|-----|-----|
| | | | kW | HP | | 100 | 150 | 200 | 250 | 300 | 350 | 400 | 430 |
| | | | | | | Head in Meter | | | | | | | |
| 7 | 4W7BR3D-65 | 7 | 2.2 | 3.0 | 65 | 35 | 33 | 30 | 27 | 23 | 19 | 14 | 10 |
| 8 | 4W7BR3DTP-65 | 7 | 2.2 | 3.0 | 65 | 35 | 33 | 30 | 27 | 23 | 19 | 14 | 10 |
| 9 | 4W7BR3D(I)-65 | 7 | 2.2 | 3.0 | 65 | 35 | 33 | 30 | 27 | 23 | 19 | 14 | 10 |

Performance Curve:

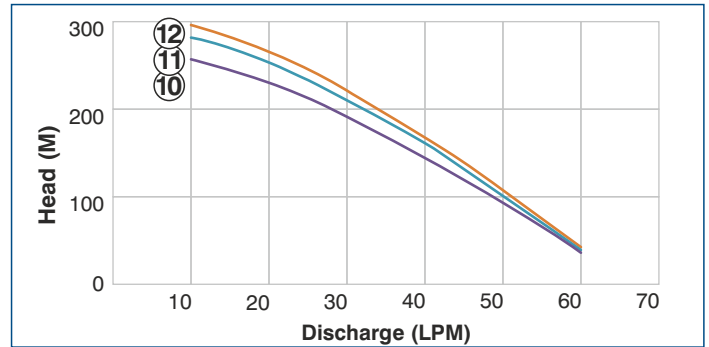
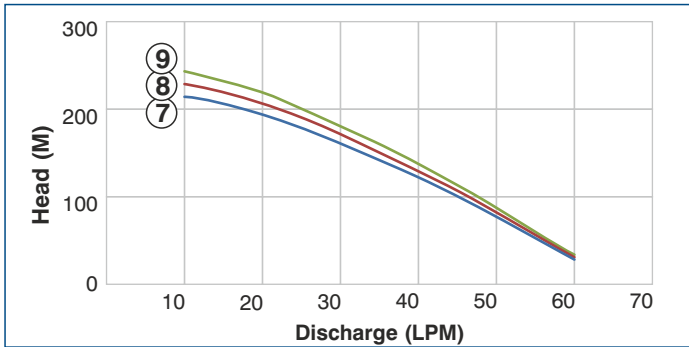
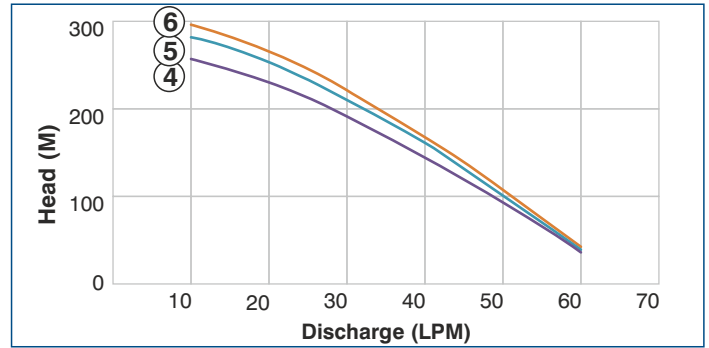
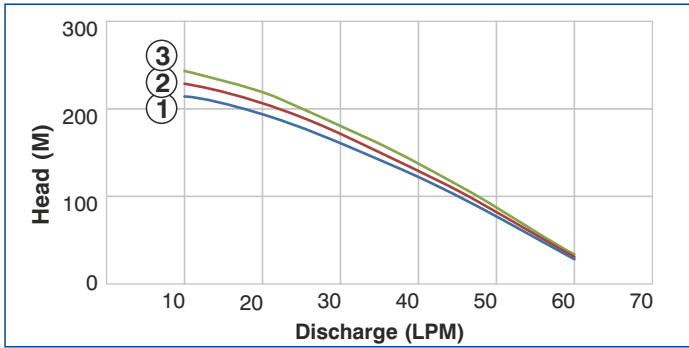

Performance Table:

| Sr. No. | Rating | No. Of Stages | Motor | | Outlet Size mm | Discharge in LPM | | | | | |
|---------|------------|---------------|-------|----|----------------|------------------|-----|-----|-----|-----|----|
| | | | kW | HP | | 10 | 20 | 30 | 40 | 50 | 60 |
| | | | | | | Head in Meter | | | | | |
| 1 | 4W32AL3DTP | 32 | 2.2 | 3 | 32 | 215 | 194 | 160 | 123 | 78 | 32 |
| 2 | 4W34AL3DTP | 34 | 2.2 | 3 | 32 | 229 | 206 | 170 | 130 | 83 | 34 |
| 3 | 4W36AL3DTP | 36 | 2.2 | 3 | 32 | 242 | 218 | 180 | 138 | 88 | 36 |
| 4 | 4W38AL3DTP | 38 | 2.2 | 3 | 32 | 255 | 230 | 190 | 146 | 93 | 38 |
| 5 | 4W42AL4DTP | 42 | 3.0 | 4 | 32 | 282 | 254 | 210 | 161 | 103 | 42 |
| 6 | 4W44AL4DTP | 44 | 3.0 | 4 | 32 | 296 | 266 | 220 | 169 | 108 | 44 |

| Sr. No. | Rating | No. Of Stages | Motor | | Outlet Size mm | Discharge in LPM | | | | | |
|---------|-------------|---------------|-------|----|----------------|------------------|-----|-----|-----|-----|----|
| | | | kW | HP | | 10 | 20 | 30 | 40 | 50 | 60 |
| | | | | | | Head in Meter | | | | | |
| 7 | 4W32AL3D(P) | 32 | 2.2 | 3 | 32 | 215 | 194 | 160 | 123 | 78 | 32 |
| 8 | 4W34AL3D(P) | 34 | 2.2 | 3 | 32 | 229 | 206 | 170 | 130 | 83 | 34 |
| 9 | 4W36AL3D(P) | 36 | 2.2 | 3 | 32 | 242 | 218 | 180 | 138 | 88 | 36 |
| 10 | 4W38AL3D(P) | 38 | 2.2 | 3 | 32 | 255 | 230 | 190 | 146 | 93 | 38 |
| 11 | 4W42AL4D(P) | 42 | 3.0 | 4 | 32 | 282 | 254 | 210 | 161 | 103 | 42 |
| 12 | 4W44AL4D(P) | 44 | 3.0 | 4 | 32 | 296 | 266 | 220 | 169 | 108 | 44 |

Note :

1. The motor ratings in HP are only indicative and for reference purpose
2. Performance figures given above are approximate and may differ on site conditions

3. Performance mentioned on nameplate may vary as we are always improving our products

Pump Dimensional Details:

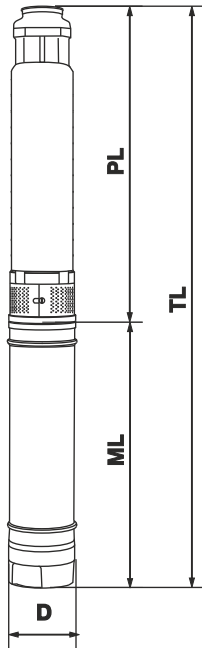

Material of Construction:

| No. | Part | Material |
|-----|---------------------------|------------------------|
| 1 | Diffuser | Noryl |
| 2 | Impeller | Noryl/Delrin |
| 3 | Pump Shaft | Stainless Steel-SS410 |
| 4 | NRV Body | Cast Iron-Grade FG 200 |
| 5 | Motor Body | Stainless Steel-SS202 |
| 6 | Pump Jacket | Stainless Steel-SS202 |
| 7 | Upper Housing, Motor Base | Cast Iron-Grade FG 200 |
| 8 | Bush | Bronze LTB-4 |
| 9 | Motor Shaft | Stainless Steel-SS420 |
| 10 | Stamping | CRNGO-M47 |
| 11 | Thrust Bearing | SS Vs Carbon |
| 12 | Strainer | Stainless Steel-SS202 |
| 13 | Fastener | Stainless Steel-SS410 |
| 14 | Sealing | Oil seal |

| All Dimensions are in mm | | | | | |
|--------------------------|-----------|--------|-------|----|------------|
| Rating | ML | PL | TL | D | |
| | Length mm | | | | Max. OD mm |
| | Motor | Pump | Total | | |
| 4W17B3J-VX | 550 | 660 | 1172 | 98 | |
| 4W17D3J-VX/4W17D3TPJ-VX | 550 | 765 | 1277 | 98 | |
| 4W30D5TPJ-VX | 675 | 1190 | 1827 | 98 | |
| 4W15E3J-VX/4W15E3TPJ-VX | 555 | 700 | 1217 | 98 | |
| 4W25E5TPJ-VX | 637 | 1092 | 1691 | 98 | |
| 4W7F3J-VX/4W7F3TPJ-VX | 550 | 882 | 1394 | 98 | |
| 4W12F5TPJ-VX | 675 | 1220 | 1857 | 98 | |
| 4W32AL3D | 622 | 1066 | 1650 | 98 | |
| 4W34AL3D | 622 | 1117 | 1701 | 98 | |
| 4W36AL3D | 622 | 1168 | 1752 | 98 | |
| 4W38AL3D | 622 | 1219 | 1803 | 98 | |
| 4W7BJ3D/4W7BJ3D-65 | 622 | 758 | 1342 | 98 | |
| 4W7BJ3DTP/4W7BJ3DTP-65 | 622 | 758 | 1342 | 98 | |
| 4W15BG3D/4W15BG3D-50 | 622 | 830 | 1420 | 98 | |
| 4W15BG3DTP/4W15BG3DTP-50 | 622 | 830 | 1420 | 98 | |
| 4W12BG3D/4W12BG3D-50 | 622 | 722 | 1306 | 98 | |
| 4W12BG3DTP/4W12BG3DTP-50 | 622 | 722 | 1306 | 98 | |
| 4W30BH3DTP | 622 | 1211.5 | 1796 | 98 | |
| 4W21BH3D/4W21BH3DTP | 622 | 945 | 1529 | 98 | |
| 4W32AL3DTP | 622 | 1066 | 1650 | 98 | |
| 4W34AL3DTP | 622 | 1117 | 1701 | 98 | |
| 4W36AL3DTP | 622 | 1168 | 1752 | 98 | |
| 4W38AL3DTP | 622 | 1219 | 1803 | 98 | |

| All Dimensions are in mm | | | | | |
|--------------------------|-----------|------|-------|----|------------|
| Rating | ML | PL | TL | D | |
| | Length mm | | | | Max. OD mm |
| | Motor | Pump | Total | | |
| 4W42AL4DTP | 622 | 1321 | 1905 | 98 | |
| 4W44AL4DTP | 680 | 1372 | 2014 | 98 | |
| 4W32AL3D(P) | 680 | 1066 | 1708 | 98 | |
| 4W34AL3D(P) | 622 | 1117 | 1701 | 98 | |
| 4W36AL3D(P) | 622 | 1168 | 1752 | 98 | |
| 4W38AL3D(P) | 622 | 1219 | 1803 | 98 | |
| 4W42AL4D(P) | 680 | 1321 | 1963 | 98 | |
| 4W44AL4D(P) | 680 | 1372 | 2014 | 98 | |
| 4W42AK5DTP | 730 | 1602 | 2294 | 98 | |
| 4W44AK5DTP | 730 | 1653 | 2345 | 98 | |
| 4W45AK5DTP | 730 | 1691 | 2383 | 98 | |
| 4W50AK5DTP | 730 | 1830 | 2522 | 98 | |
| 4W12BR5DTP-65 | 680 | 1016 | 1696 | 98 | |
| 4W10BR5DTP-65 | 680 | 836 | 1516 | 98 | |
| 4W12BR5D(I)-65 | 680 | 1016 | 1696 | 98 | |
| 4W10BR5D(I)-65 | 680 | 836 | 1516 | 98 | |
| 4W6BR2D-65 | 550 | 587 | 1137 | 98 | |
| 4W6BR2DTP-65 | 550 | 587 | 1137 | 98 | |
| 4W6BR2D(I)-65 | 540 | 587 | 1127 | 98 | |
| 4W6MQ2C(I)-65 | 540 | 587 | 1127 | 98 | |
| 4W6MQ2C-65 | 540 | 587 | 1127 | 98 | |
| 4W7BR3D-65 | 622 | 662 | 1284 | 98 | |
| 4W7BR3DTP-65 | 622 | 662 | 1284 | 98 | |
| 4W7BR3D(I)-65 | 612 | 662 | 1274 | 98 | |

100W Series Borewell Submersible Pumps



High Grade Electrical Stampings

Reduced Electrical losses lowers the operating current of the pump



Lower Operating Current

Robust Electrical Design Ensures Lower Electrical Current and Lower Power Bill



Wide Voltage application

Designed to withstand wide voltage fluctuations & Provides Consistent Performance



High Thrust Capacity

Specially designed thrust bearing ensures highest reliability



Easy For Maintenance

Easily replaceable wear & tear Parts, Low maintenance cost

Technical Specifications:

- Range: 3.0HP to 7.5HP (2.2kW to 5.5kW)
- Rated voltage: 220V for 1PH & 415V for 3PH
- Voltage range: 180V – 240V for 1PH & 350V -440V for 3PH
- Rated Frequency: 50Hz
- Delivery pipe size: 32mm to 65mm
- Max. Head: Upto 263 meter
- Max. Discharge: Upto 600LPM
- Liquid: Clear water
- Motor type: Water filled motor

Application:

- Sprinkler irrigation
- Drip irrigation
- Agricultural farms
- Multistoried Buildings
- Construction sites
- Water supply for Industrial / Commercial Establishment
- Ornamental Fountains



Performance Curve:

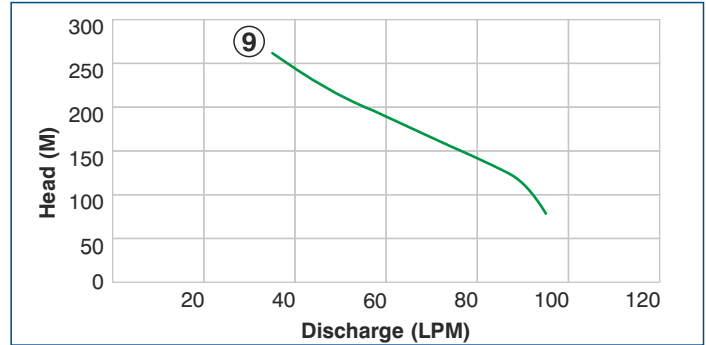
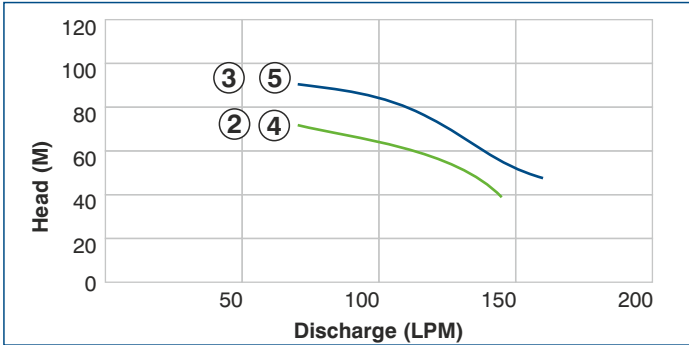
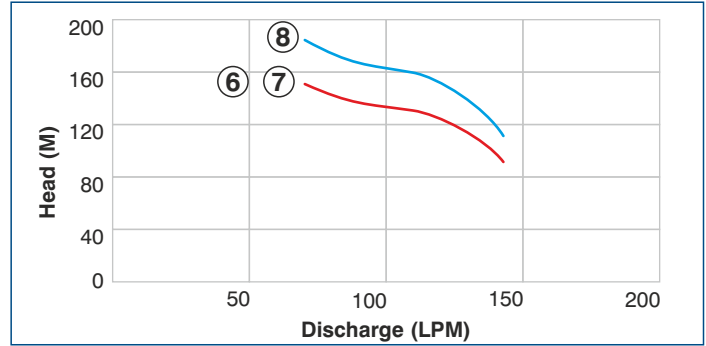
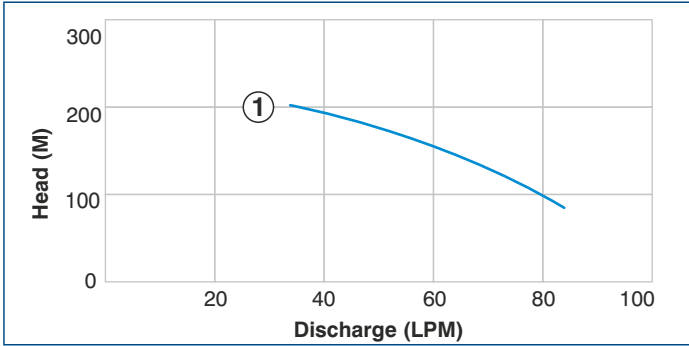

Performance Table:

| Sr. No. | Rating | No. Of Stages | Motor | | Outlet Size mm | Discharge in LPM | | | | | |
|---------|--------------|---------------|-------|----|----------------|------------------|-----|-----|-----|-----|----|
| | | | kW | HP | | 34 | 42 | 54 | 57 | 72 | 84 |
| | | | | | | Head in Meter | | | | | |
| 1 | 100W30RH3-TP | 30 | 2.2 | 3 | 32 | 200 | 197 | 184 | 170 | 132 | 80 |

| Sr. No. | Rating | No. Of Stages | Motor | | Outlet Size mm | Discharge in LPM | | | | | |
|---------|-----------------------------|---------------|-------|----|----------------|------------------|-----|-----|-----|-----|-----|
| | | | kW | HP | | 70 | 85 | 110 | 130 | 145 | 160 |
| | | | | | | Head in Meter | | | | | |
| 2 | 100W12RA3/100W12RA3-50 | 12 | 2.2 | 3 | 38/50 | 72 | 64 | 62 | 54 | 40 | - |
| 3 | 100W15RA3/100W15RA3-50 | 15 | 2.2 | 3 | 38/50 | 90 | 80 | 78 | 68 | 50 | 44 |
| 4 | 100W12RA3TP/100W12RA3TP-50 | 12 | 2.2 | 3 | 38/50 | 72 | 64 | 62 | 54 | 40 | - |
| 5 | 100W15RA3TP/100W15RA3TP-50 | 15 | 2.2 | 3 | 38/50 | 90 | 80 | 78 | 68 | 50 | - |
| 6 | 100W25RA5 | 25 | 3.7 | 5 | 38 | 150 | 133 | 129 | 113 | 83 | - |
| 7 | 100W25RA5TP/ 100W25RA5TP-50 | 25 | 3.7 | 5 | 38/50 | 150 | 133 | 129 | 113 | 83 | - |
| 8 | 100W31RA6-TP | 31 | 4.5 | 5 | 38 | 186 | 165 | 160 | 140 | 103 | - |

| Sr. No. | Rating | No. Of Stages | Motor | | Outlet Size mm | Discharge in LPM | | | | |
|---------|-------------------------|---------------|-------|----|----------------|------------------|-----|----|----|-----|
| | | | kW | HP | | 35 | 50 | 80 | 90 | 100 |
| | | | | | | Head in Meter | | | | |
| 9 | 100W21RJ3/ 100W21RJ3-TP | 21 | 2.2 | 3 | 32 | 138 | 113 | 75 | 60 | 42 |

Performance Curve:

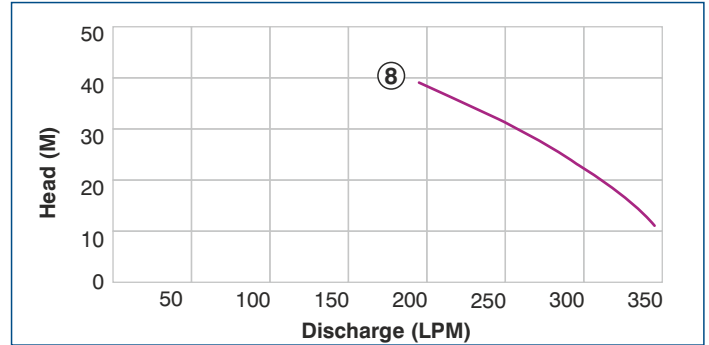
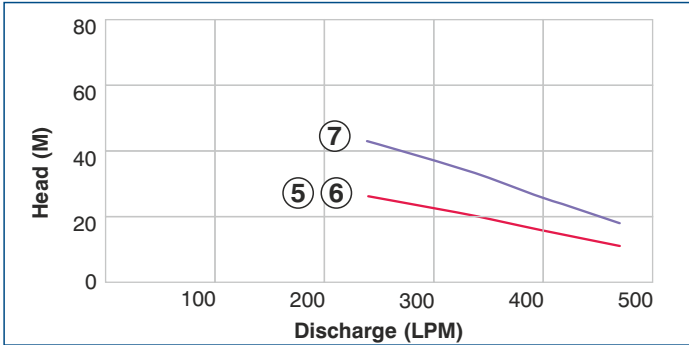
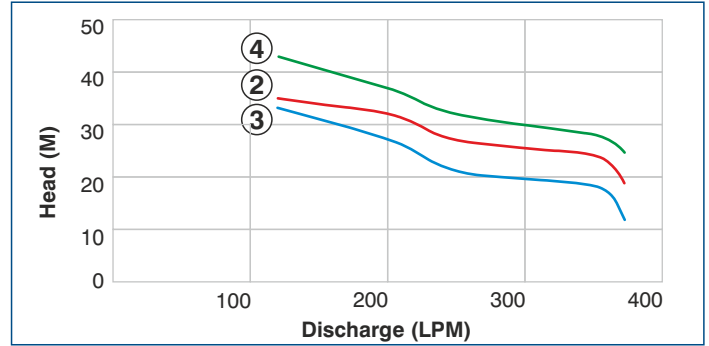
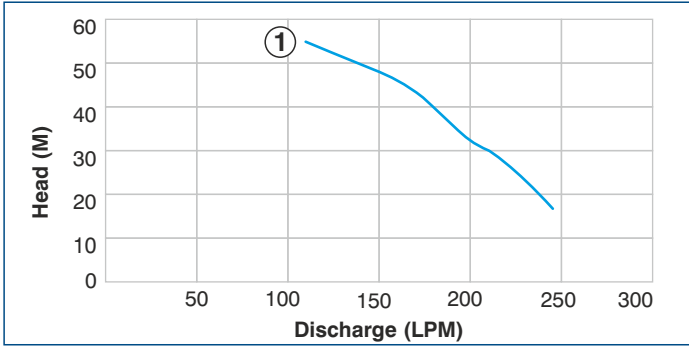

Performance Table:

| Sr. No. | Rating | No. Of Stages | Motor | | Outlet Size mm | Discharge in LPM | | | | |
|---------|-----------|---------------|-------|----|----------------|------------------|----|----|----|-----|
| | | | kW | HP | | 35 | 50 | 80 | 90 | 100 |
| | | | | | | Head in Meter | | | | |
| 1 | 100W10RP3 | 10 | 2.2 | 3 | 50 | 55 | 45 | 34 | 29 | 17 |

| Sr. No. | Rating | No. Of Stages | Motor | | Outlet Size mm | Discharge in LPM | | | | |
|---------|----------------------|---------------|-------|----|----------------|------------------|-----|-----|-----|-----|
| | | | kW | HP | | 120 | 200 | 250 | 350 | 370 |
| | | | | | | Head in Meter | | | | |
| 2 | 100W7RQ3/100W7RQ3-TP | 7 | 2.2 | 3 | 65 | 35 | 32 | 27 | 24 | 19 |
| 3 | 100W6RS3/100W6RS3-TP | 6 | 2.2 | 3 | 65 | 33 | 27 | 21 | 18 | 12 |
| 4 | 100W7RS3/100W7RS3-TP | 7 | 2.2 | 3 | 65 | 43 | 37 | 32 | 28 | 25 |

| Sr. No. | Rating | No. Of Stages | Motor | | Outlet Size mm | Discharge in LPM | | | | |
|---------|------------------------|---------------|-------|----|----------------|------------------|-----|-----|-----|-----|
| | | | kW | HP | | 240 | 340 | 380 | 425 | 470 |
| | | | | | | Head in Meter | | | | |
| 5 | 100W6MS3 / 100W6MS3(I) | 6 | 2.2 | 3 | 65 | 26 | 20 | 17 | 14 | 11 |
| 6 | 100W6MS3-TP | 6 | 2.2 | 3 | 65 | 26 | 20 | 17 | 14 | 11 |
| 7 | 100W10MS5-TP | 10 | 3.7 | 5 | 65 | 43 | 33 | 28 | 23 | 18 |

| Sr. No. | Rating | No. Of Stages | Motor | | Outlet Size mm | Discharge in LPM | | | | |
|---------|-------------|---------------|-------|----|----------------|------------------|-----|-----|-----|-----|
| | | | kW | HP | | 195 | 245 | 280 | 320 | 345 |
| | | | | | | Head in Meter | | | | |
| 8 | 100W9MT3-TP | 9 | 2.2 | 3 | 50 | 39 | 32 | 26 | 18 | 11 |

Performance Curve:

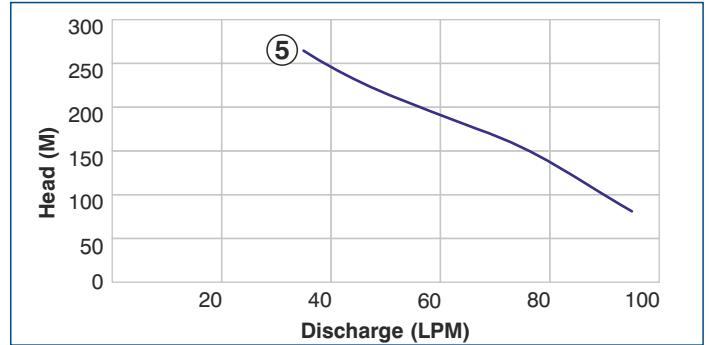
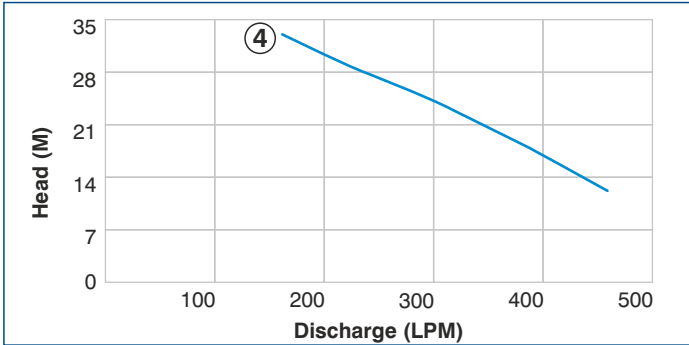
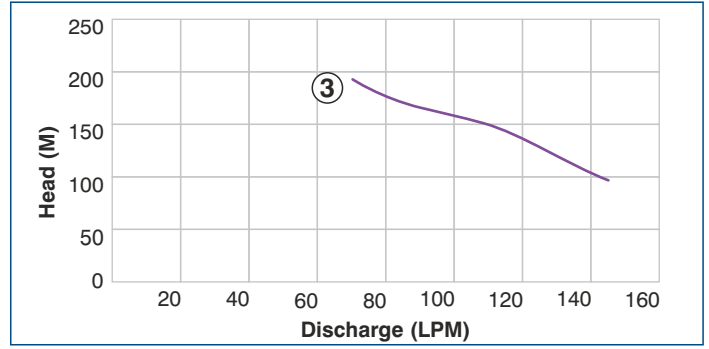
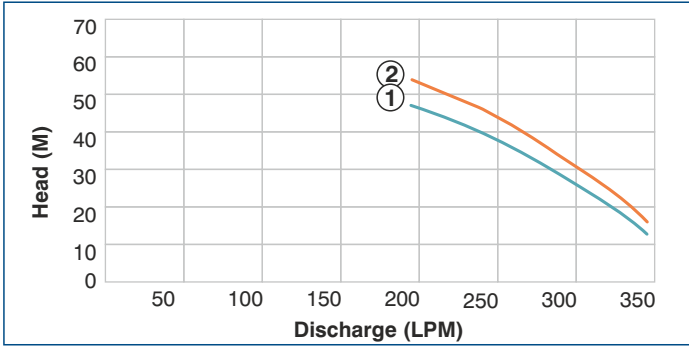

Performance Table:

| Sr. No. | Rating | No. Of Stages | Motor | | Outlet Size mm | Discharge in LPM | | | | |
|---------|--------------|---------------|-------|----|----------------|------------------|-----|-----|-----|-----|
| | | | kW | HP | | Head in Meter | | | | |
| | | | | | | 195 | 245 | 280 | 320 | 345 |
| 1 | 100W12MT5-TP | 12 | 3.7 | 5 | 50 | 54 | 45 | 36 | 25 | 16 |
| 2 | 100W14MT5-TP | 14 | 3.7 | 5 | 50 | 58 | 48 | 38 | 27 | 17 |

| Sr. No. | Rating | No. Of Stages | Motor | | Outlet Size mm | Discharge in LPM | | | | |
|---------|---------------|---------------|-------|-----|----------------|------------------|-----|-----|-----|-----|
| | | | kW | HP | | Head in Meter | | | | |
| | | | | | | 70 | 85 | 110 | 130 | 145 |
| 3 | 100W31RA7.5TP | 31 | 5.5 | 7.5 | 50 | 192 | 170 | 150 | 122 | 99 |

| Sr. No. | Rating | No. Of Stages | Motor | | Outlet Size mm | Discharge in LPM | | | | | | |
|---------|----------------|---------------|-------|----|----------------|------------------|-----|-----|-----|-----|-----|-----|
| | | | kW | HP | | Head in Meter | | | | | | |
| | | | | | | 165 | 210 | 263 | 305 | 345 | 380 | 455 |
| 4 | 100W7MQ3(I)-65 | 7 | 2.2 | 3 | 65 | 33 | 30 | 27 | 24 | 21 | 18 | 12 |

| Sr. No. | Rating | No. Of Stages | Motor | | Outlet Size mm | Discharge in LPM | | | | |
|---------|--------------|---------------|-------|----|----------------|------------------|-----|-----|-----|----|
| | | | kW | HP | | Head in Meter | | | | |
| | | | | | | 35 | 50 | 80 | 90 | 95 |
| 5 | 100W40RJ5-TP | 40 | 3.7 | 5 | 32 | 263 | 215 | 143 | 115 | 80 |

Performance Curve:

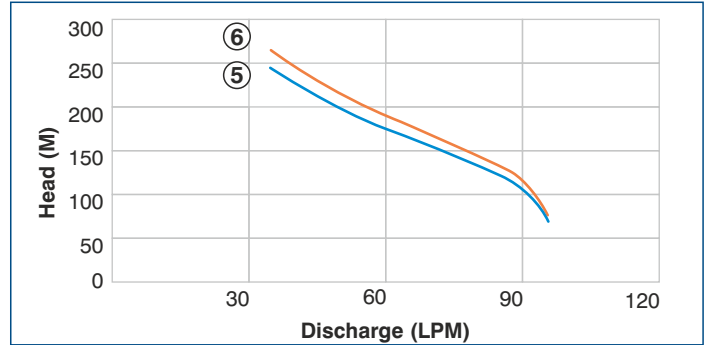
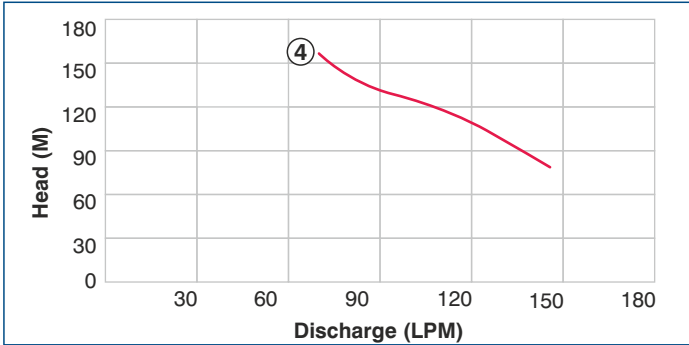
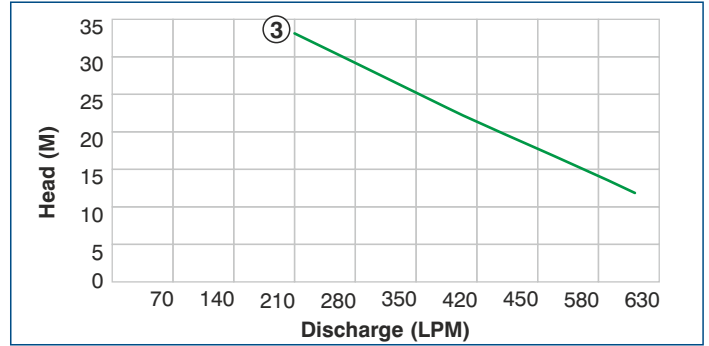
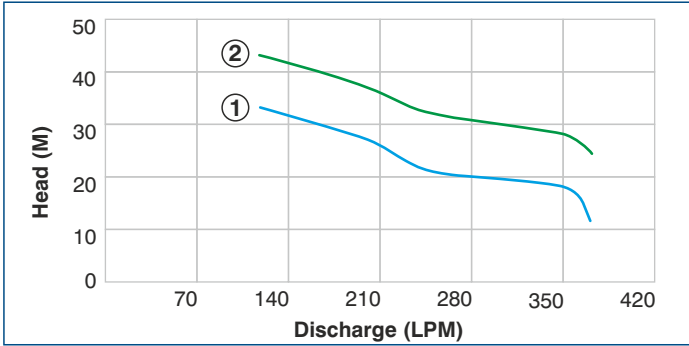

Performance Table:

| Sr. No. | Rating | No. Of Stages | Motor | | Outlet Size mm | Discharge in LPM | | | | |
|---------|------------|---------------|-------|-----|----------------|------------------|-----|-----|-----|-----|
| | | | kW | HP | | 120 | 200 | 250 | 350 | 370 |
| | | | | | | Head in Meter | | | | |
| 1 | 100W6RS3TP | 6 | 2.2 | 3.0 | 65 | 33 | 21 | 21 | 18 | 12 |
| 2 | 100W7RS3TP | 7 | 2.2 | 3.0 | 65 | 37 | 32 | 32 | 28 | 25 |

| Sr. No. | Rating | No. Of Stages | Motor | | Outlet Size mm | Discharge in LPM | | | | | | |
|---------|---------------|---------------|-------|-----|----------------|------------------|-----|-----|-----|-----|-----|-----|
| | | | kW | HP | | 210 | 260 | 320 | 370 | 425 | 485 | 600 |
| | | | | | | Head in Meter | | | | | | |
| 3 | 100W7MQ3TP-65 | 7 | 2.2 | 3.0 | 65 | 33 | 30 | 27 | 24 | 21 | 18 | 12 |

| Sr. No. | Rating | No. Of Stages | Motor | | Outlet Size mm | Discharge in LPM | | | | |
|---------|--------------|---------------|-------|-----|----------------|------------------|-----|-----|-----|-----|
| | | | kW | HP | | 70 | 85 | 110 | 130 | 145 |
| | | | | | | Head in Meter | | | | |
| 4 | 100W25RA6(P) | 25 | 4.5 | 6.0 | 50 | 155 | 135 | 118 | 98 | 80 |

| Sr. No. | Rating | No. Of Stages | Motor | | Outlet Size mm | Discharge in LPM | | | | |
|---------|--------------|---------------|-------|-----|----------------|------------------|-----|-----|-----|----|
| | | | kW | HP | | 35 | 50 | 80 | 90 | 95 |
| | | | | | | Head in Meter | | | | |
| 5 | 100W37RJ6(P) | 37 | 4.5 | 6.0 | 32 | 243 | 199 | 132 | 106 | 74 |
| 6 | 100W40RJ6(P) | 40 | 4.5 | 6.0 | 32 | 263 | 215 | 143 | 115 | 80 |

Note :

1. The motor ratings in HP are only indicative and for reference purpose
2. Performance figures given above are approximate and may differ on site conditions

3. Performance mentioned on nameplate may vary as we are always improving our products

Pump Dimensional Details:

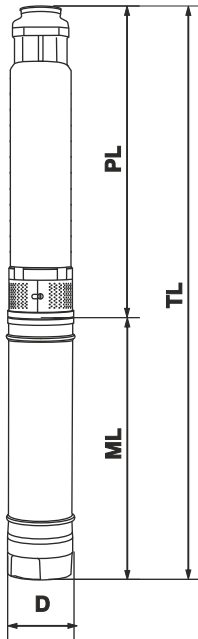

Material of Construction:

| No. | Part | Material |
|-----|---------------------------|------------------------|
| 1 | Diffuser | Noryl |
| 2 | Impeller | Noryl |
| 3 | Pump Shaft | Stainless Steel-SS410 |
| 4 | NRV Body | Cast Iron-Grade FG 200 |
| 5 | Motor Body | Stainless Steel-SS202 |
| 6 | Pump Jacket | Cast Iron-Grade FG 200 |
| 7 | Upper Housing, Motor Base | Stainless Steel-SS202 |
| 8 | Bush | Bronze LTB-4 |
| 9 | Motor Shaft | Stainless Steel-SS420 |
| 10 | Stamping | CRNGO-M47 |
| 11 | Thrust Bearing | SS Vs Carbon |
| 12 | Strainer | Stainless Steel-SS202 |
| 13 | Fastener | Stainless Steel-SS410 |
| 14 | Sealing | Oil seal |

| All Dimensions are in mm | | | | | |
|--------------------------------|-----------|------|-------|----|---------------|
| Rating | ML | PL | TL | D | |
| | Length mm | | | | Max. OD mm |
| | Motor | Pump | Total | | |
| 100W30RH3TP | 710 | 1103 | 1775 | 98 | |
| 100W40RH5TP | 810 | 1296 | 2068 | 98 | |
| 100W12RA3/100W12RA3-50 | 730 | 626 | 1318 | 98 | |
| 100W15RA3/100W15RA3-50 | 730 | 735 | 1427 | 98 | |
| 100W12RA3TP/ 100W12RA3TP-50 | 710 | 626 | 1298 | 98 | |
| 100W15RA3TP/ 100W15RA3TP-50 | 710 | 735 | 1407 | 98 | |
| 100W25RA5 | 950 | 1096 | 2008 | 98 | |
| 100W25RA5TP/ 100W25RA5TP-50 | 810 | 1096 | 1868 | 98 | |
| 100W31RA6TP | 870 | 1325 | 2157 | 98 | |
| 100W21RJ3/100W21RJ3TP | 730 | 773 | 1465 | 98 | |
| 100W10RP3 | 730 | 846 | 1538 | 98 | |

| All Dimensions are in mm | | | | | |
|--------------------------|-----------|------|-------|----|---------------|
| Rating | ML | PL | TL | D | |
| | Length mm | | | | Max. OD mm |
| | Motor | Pump | Total | | |
| 100W7RQ3/100W7RQ3TP | 730 | 848 | 1540 | 98 | |
| 100W6RS3/100W6RS3TP | 730 | 784 | 1476 | 98 | |
| 100W7RS3/100W7RS3TP | 730 | 859 | 1551 | 98 | |
| 100W6MS3 / 100W6MS3(I) | 710 | 784 | 1456 | 98 | |
| 100W6MS3TP | 750 | 784 | 1496 | 98 | |
| 100W10MS5TP | 870 | 1084 | 1916 | 98 | |
| 100W9MT3TP | 750 | 998 | 1710 | 98 | |
| 100W12MT5TP | 810 | 1223 | 1995 | 98 | |
| 100W14MT5TP | 870 | 1373 | 2205 | 98 | |
| 100W31RA7.5TP | 950 | 1325 | 2237 | 98 | |
| 100W7MQ3(I)-65 | 730 | 885 | 1577 | 98 | |
| 100W40RJ5TP | 810 | 1296 | 2068 | 98 | |
| 100W6RS3TP | 750 | 784 | 1496 | 98 | |
| 100W7MQ3TP-65 | 750 | 784 | 1496 | 98 | |

4VO Series Borewell Submersible Pumps



High Grade Electrical Stampings

Reduced Electrical losses lowers the operating current of the pump



High Quality Noryl

High quality virgin noryl components give longer life



Lower Operating Current

Robust Electrical Design Ensures Lower Electrical Current and Lower Power Bill



Anti-Rust CED Coating

Offers rust free and stuck free operation



In Built Check Valve

In built check valve prevents pump parts from damage due to sudden back pressure



Easy To Repair

Easily replaceable wear & tear Parts, Low maintenance cost

Technical Specifications:

- Range: 3.0HP/2.2kW
- Rated voltage: 220V for 1PH & 415V for 3PH
- Voltage range: 180V – 240V for 1PH & 350V – 440V for 3PH
- Rated Frequency: 50Hz
- Delivery pipe size: 38mm & 65mm
- Max. Head: Upto 90meter
- Max. Discharge: Upto 500LPM
- Liquid: Clear water
- Motor type: Oil filled motor

Application:

- Sprinkler irrigation
- Drip irrigation
- Agricultural farms
- Multistoried Buildings
- Construction sites
- Water supply for Industrial / Commercial Establishment
- Gardening



Performance Curve:

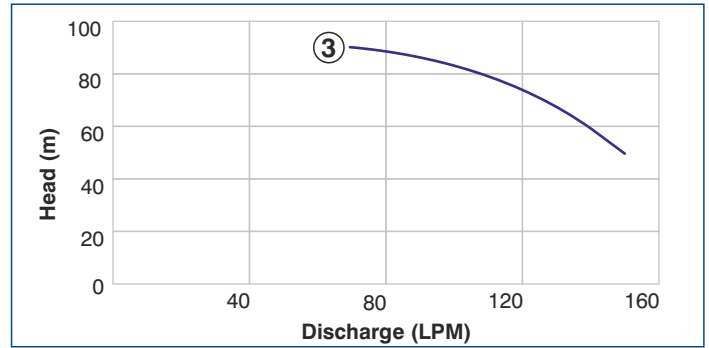
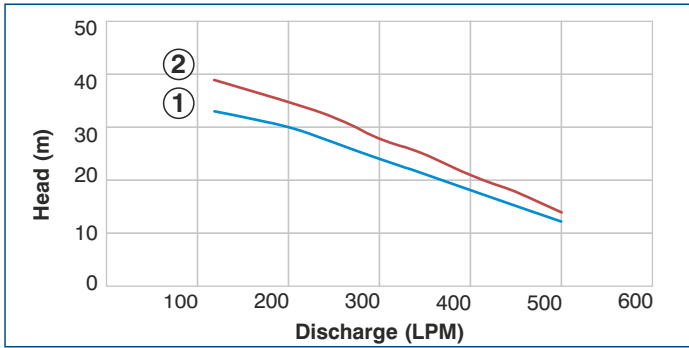

Performance Table:

| Sr. No. | Rating | No. Of Stages | Motor | | Outlet Size mm | Discharge in LPM | | | | | | | |
|---------|-------------------|---------------|-------|----|----------------|------------------|-----|-----|-----|-----|-----|-----|-----|
| | | | kW | HP | | 120 | 200 | 250 | 300 | 350 | 400 | 450 | 500 |
| 1 | 4VO6RS3/4VO6RS3TP | 6 | 2.2 | 3 | 65 | 33 | 30 | 27 | 24 | 21 | 18 | 15 | 12 |
| 2 | 4VO7RS3/4VO7RS3TP | 7 | 2.2 | 3 | 65 | 39 | 35 | 32 | 28 | 25 | 21 | 18 | 14 |

| Sr. No. | Rating | No. Of Stages | Motor | | Outlet Size mm | Discharge in LPM | | | | |
|---------|----------|---------------|-------|----|----------------|------------------|----|-----|-----|-----|
| | | | kW | HP | | 70 | 85 | 110 | 130 | 150 |
| 3 | 4VO15RA3 | 15 | 2.2 | 3 | 38 | 90 | 80 | 78 | 68 | 50 |

Note :

1. The motor ratings in HP are only indicative and for reference purpose
2. Performance figures given above are approximate and may differ on site conditions

3. Performance mentioned on nameplate may vary as we are always improving our products

Pump Dimensional Details:

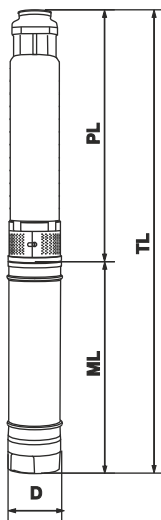

Material of Construction:

| No. | Part | Material |
|-----|---------------|--|
| 1 | Bowl | Noryl / Cast Iron-Grade FG 200 |
| 2 | Impeller | Noryl / Cast Iron-Grade FG 200 |
| 3 | Pump Shaft | Stainless Steel-SS410 |
| 4 | NRV Body | Cast Iron-Grade FG 200 |
| 5 | Motor Body | Stainless Steel-SS304 |
| 6 | Pump Jacket | Stainless Steel-SS202 |
| 7 | Upper Housing | Cast Iron-Grade FG 200 |
| 8 | Bearing | Standard |
| 9 | Motor Shaft | Stainless Steel-SS410 |
| 10 | Stamping | CRNGO-M47 |
| 11 | Strainer | Stainless Steel-SS202 |
| 12 | Fastener | Stainless Steel-SS410 |
| 13 | Sealing | Oil seal/Mechanical seal (Ceramic Vs Carbon) |
| 14 | Motor Base | Cast Iron-Grade FG 200 |

| All Dimensions are in mm | | | | |
|--------------------------|--------------|------|-------|------------|
| Rating | ML | PL | TL | D |
| | Length In MM | | | |
| | Motor | Pump | Total | Max. OD MM |
| 4VO6RS3/4VO6RS3TP | 496 | 784 | 1242 | 98 |
| 4VO7RS3/4VO7RS3TP | 496 | 859 | 1317 | 98 |
| 4VO15RA3 | 496 | 726 | 1184 | 98 |

4CSS Series Stainless Steel Borewell Submersible Pumps



High Grade Stainless Steel

Pure SS304 stainless steel construction resists corrosion and withstand tough operating conditions



Less Power Consumption

High operating efficiency results in high flow rate and low electricity bill



High Grade Electrical Stamping

Reduces electrical losses and improves pump efficiency



High Thrust Capacity

Specially designed thrust bearing ensures highest reliability



Easy For Maintenance

Easily replaceable wear & tear Parts, Low maintenance cost

Technical Specifications:

- Range: 3.0HP to 7.5HP (2.2kW to 5.5kW)
- Rated voltage: 220V for 1PH & 415V for 3PH
- Voltage range: 180V – 240V for 1PH & 350V - 440V for 3PH
- Rated Frequency: 50Hz
- Delivery pipe size: 32mm & 40mm
- Max. Head: Upto 405 meter
- Max. Discharge: Upto 100LPM
- Liquid: Clear water
- Motor type: Water filled motor

Application:

- Sprinkler irrigation
- Drip irrigation
- Agricultural farms
- Multistoried Buildings
- Construction sites
- Water supply for Industrial / Commercial Establishment
- Ornamental Fountains



Performance Curve:

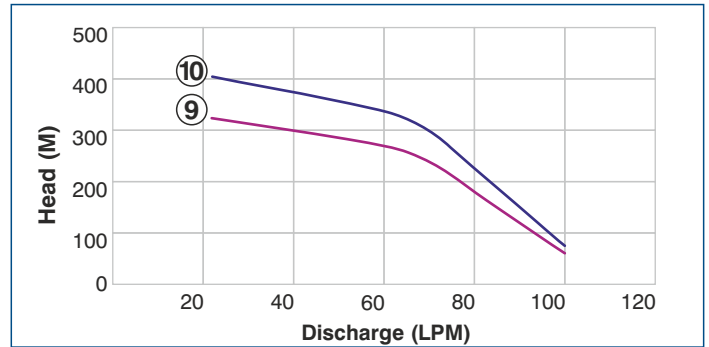
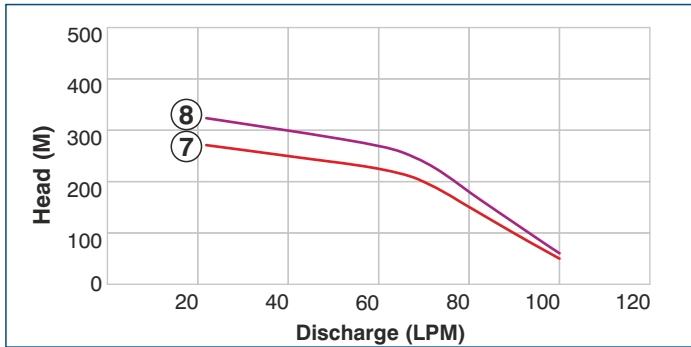
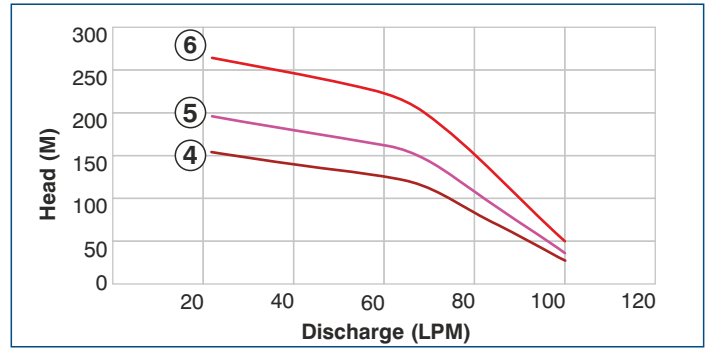
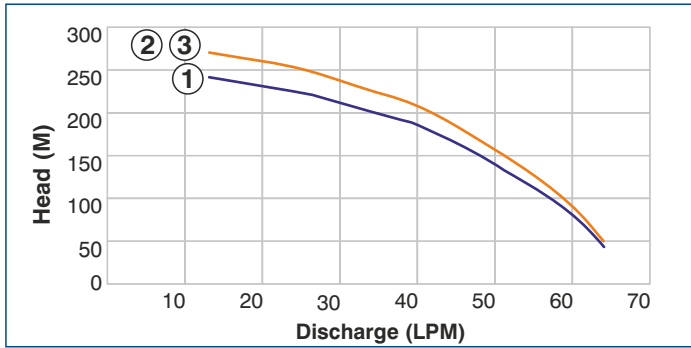

Performance Table:

| Sr. No. | Rating | No. Of Stages | Motor | | Outlet Size mm | Discharge in LPM | | | | | | |
|---------|--------------------------------|---------------|-------|----|----------------|------------------|-----|-----|-----|-----|-----|----|
| | | | kW | HP | | 13 | 25 | 34 | 42 | 51 | 59 | 64 |
| | | | | | | Head in Meter | | | | | | |
| 1 | 4CSSF3-3045/4CSSF3-3045(3PH) | 45 | 2.2 | 3 | 32 | 243 | 225 | 202 | 180 | 135 | 90 | 45 |
| 2 | 4CSSF3-3050 / 4CSSF3-3050(3PH) | 50 | 2.2 | 3 | 32 | 270 | 250 | 225 | 200 | 150 | 100 | 50 |
| 3 | 4CSSF3-5050(3PH) | 50 | 3.7 | 5 | 32 | 270 | 250 | 225 | 200 | 150 | 100 | 50 |

| Sr. No. | Rating | No. Of Stages | Motor | | Outlet Size mm | Discharge in LPM | | | | | | |
|---------|------------------------------|---------------|-------|----|----------------|------------------|-----|-----|-----|-----|-----|-----|
| | | | kW | HP | | 22 | 40 | 60 | 70 | 80 | 90 | 100 |
| | | | | | | Head in Meter | | | | | | |
| 4 | 4CSSF5-3030/4CSSF5-3030(3PH) | 30 | 2.2 | 3 | 40 | 165 | 150 | 135 | 120 | 90 | 60 | 30 |
| 5 | 4CSSF5-3036/4CSSF5-3036(3PH) | 36 | 2.2 | 3 | 40 | 198 | 180 | 162 | 144 | 108 | 72 | 36 |
| 6 | 4CSSF5-5050(3PH) | 50 | 3.7 | 5 | 40 | 270 | 250 | 225 | 200 | 150 | 100 | 50 |

| Sr. No. | Rating | No. Of Stages | Motor | | Outlet Size mm | Discharge in LPM | | | | | | |
|---------|------------------|---------------|-------|-----|----------------|------------------|-----|-----|-----|-----|-----|-----|
| | | | kW | HP | | 22 | 40 | 60 | 70 | 80 | 90 | 100 |
| | | | | | | Head in Meter | | | | | | |
| 7 | 4CSSF5-6050(3PH) | 50 | 4.5 | 6 | 40 | 270 | 250 | 225 | 200 | 150 | 100 | 50 |
| 8 | 4CSSF5-6060(3PH) | 60 | 4.5 | 6 | 40 | 324 | 300 | 270 | 240 | 180 | 120 | 60 |
| 9 | 4CSSF5-7560(3PH) | 60 | 5.5 | 7.5 | 40 | 324 | 300 | 270 | 240 | 180 | 120 | 60 |
| 10 | 4CSSF5-7575(3PH) | 75 | 5.5 | 7.5 | 40 | 405 | 375 | 338 | 300 | 225 | 150 | 75 |

Note :

1. The motor ratings in HP are only indicative and for reference purpose
2. Performance figures given above are approximate and may differ on site conditions

3. Performance mentioned on nameplate may vary as we are always improving our products

Material of Construction:

| No. | Part | Material |
|-----|---------------------------|------------------------------|
| 1 | Diffuser | Stainless Steel-SS304 |
| 2 | Impeller | Stainless Steel-SS304 |
| 3 | Pump Shaft | Stainless Steel-SS410/SS431 |
| 4 | NRV Body | Cast Iron-Grade FG 200/SS304 |
| 5 | Motor Body | Stainless Steel-SS202 |
| 6 | Upper Housing, Motor Base | Cast Iron-Grade FG 200 |
| 7 | Bush | Bronze LTB-4 |
| 8 | Motor Shaft | Stainless Steel-SS420 |
| 9 | Stamping | CRNGO-M47 |
| 10 | Thrust Bearing | SS Vs Carbon |
| 11 | Strainer | Stainless Steel-SS202 |
| 12 | Fastener | Stainless Steel-SS304 |
| 13 | Sealing | Oil seal |

Pump Dimensional Details:

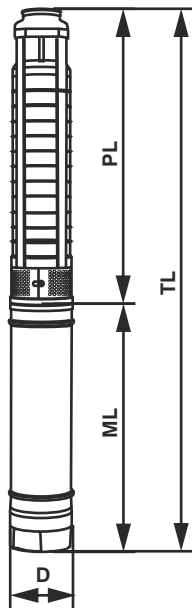

| All Dimensions are in mm | | | | | |
|-----------------------------------|-----------|------|-------|----|---------------|
| Rating | ML | PL | TL | D | |
| | Length mm | | | | Max. OD mm |
| | Motor | Pump | Total | | |
| 4CSSF3-3045 / 4CSSF3-3045(3PH) | 699 | 1245 | 1906 | 98 | |
| 4CSSF3-3050 / 4CSSF3-3050(3PH) | 699 | 1390 | 2051 | 98 | |
| 4CSSF3-5050(3PH) | 809 | 1390 | 2161 | 98 | |
| 4CSSF5-3030/ 4CSSF5-3030(3PH) | 699 | 904 | 1565 | 98 | |
| 4CSSF5-3036/ 4CSSF5-3036(3PH) | 699 | 1041 | 1702 | 98 | |
| 4CSSF5-5050(3PH) | 809 | 1390 | 2161 | 98 | |
| 4CSSF5-6050(3PH) | 839 | 1390 | 2191 | 98 | |
| 4CSSF5-6060(3PH) | 839 | 1618 | 2419 | 98 | |
| 4CSSF5-7560(3PH) | 899 | 1618 | 2479 | 98 | |
| 4CSSF5-7575(3PH) | 899 | 1990 | 2851 | 98 | |

5W / 125W Series Borewell Submersible Pumps



High Grade Electrical Stampings

Reduced Electrical losses lowers the operating current of the pump



Lower Operating Current

Robust Electrical Design Ensures Lower Electrical Current and Lower Power Bill



In Built Check Valve

In built check valve prevents pump parts from damage due to sudden back pressure

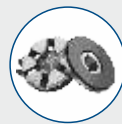

High Thrust Capacity

Specially designed thrust bearing ensures highest reliability



Easy For Maintenance

Easily replaceable wear & tear Parts, Low maintenance cost

Technical Specifications:

- Range: 3.0HP to 10HP (2.2kW to 7.5kW)
- Rated voltage: 5W-380V, 125W-350V
- Voltage range: 5W-300-440V, 125W-200-400V
- Rated Frequency: 50Hz
- Delivery pipe size: 32mm to 80mm
- Max. Head: Upto 480meter
- Max. Discharge: Upto 660LPM
- Liquid: Clear water
- Motor type: Water filled motor

Application:

- Sprinkler irrigation
- Drip irrigation
- Agricultural farms
- Multistoried Buildings
- Construction sites
- Water supply for Industrial / Commercial Establishment
- Gardening



Performance Curve:

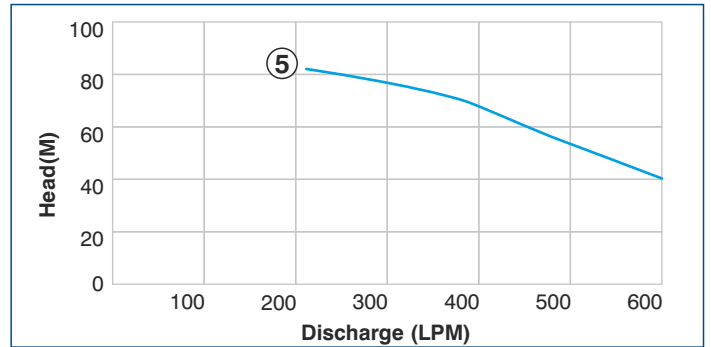
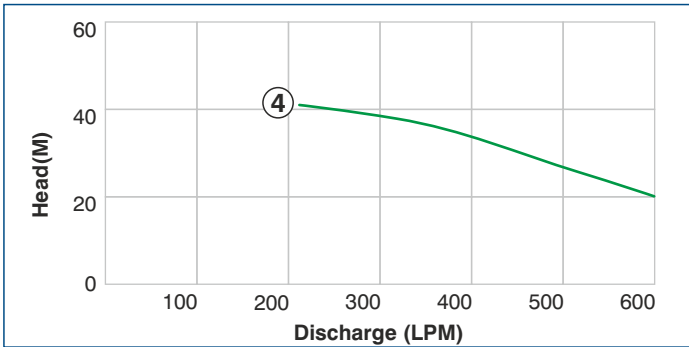
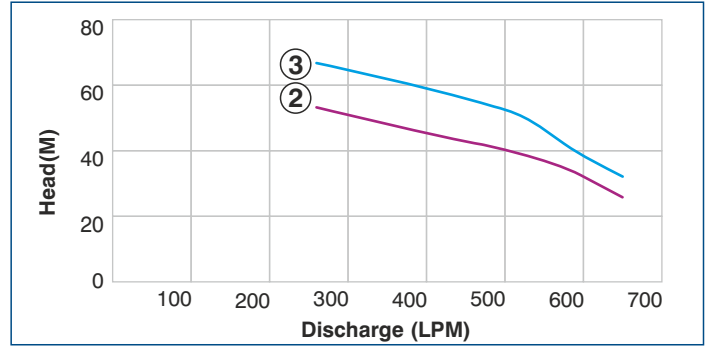
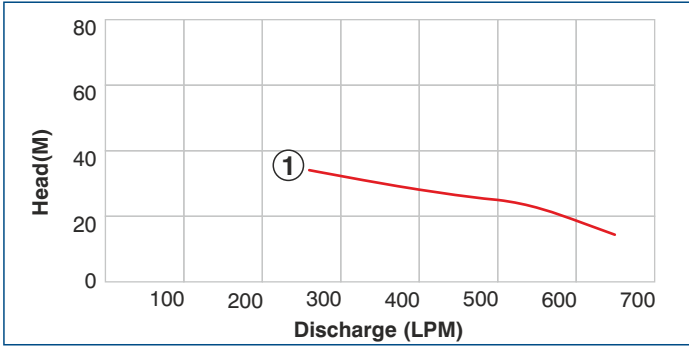

Performance Table:

| Sr. No. | Rating | No. Of Stages | Motor | | Outlet Size mm | Discharge in LPM | | | | | |
|---------|-------------------|---------------|-------|-----|----------------|------------------|-----|-----|-----|-----|-----|
| | | | kW | HP | | 260 | 390 | 480 | 530 | 580 | 660 |
| | | | | | | Head in Meter | | | | | |
| 1 | 5W4D5/125W4D5 | 4 | 3.7 | 5 | 80 | 33 | 29 | 27 | 24 | 20 | 16 |
| 2 | 5W6D7.5/125W6D7.5 | 6 | 5.5 | 7.5 | 80 | 50 | 44 | 40 | 36 | 30 | 24 |
| 3 | 5W8D10/125W8D10 | 8 | 7.5 | 10 | 80 | 66 | 60 | 54 | 46 | 40 | 32 |

| Sr. No. | Rating | No. Of Stages | Motor | | Outlet Size mm | Discharge in LPM | | | | | |
|---------|---------------|---------------|-------|----|----------------|------------------|-----|-----|-----|-----|-----|
| | | | kW | HP | | 228 | 348 | 420 | 480 | 540 | 600 |
| | | | | | | Head in Meter | | | | | |
| 4 | 5W5C5/125W5C5 | 5 | 3.7 | 5 | 80 | 41 | 38 | 33 | 29 | 25 | 20 |

| Sr. No. | Rating | No. Of Stages | Motor | | Outlet Size mm | Discharge in LPM | | | | | |
|---------|-------------------|---------------|-------|----|----------------|------------------|-----|-----|-----|-----|-----|
| | | | kW | HP | | 228 | 348 | 420 | 480 | 540 | 600 |
| | | | | | | Head in Meter | | | | | |
| 5 | 5W10C10/125W10C10 | 10 | 7.5 | 10 | 80 | 82 | 76 | 66 | 58 | 50 | 40 |

Performance Curve:

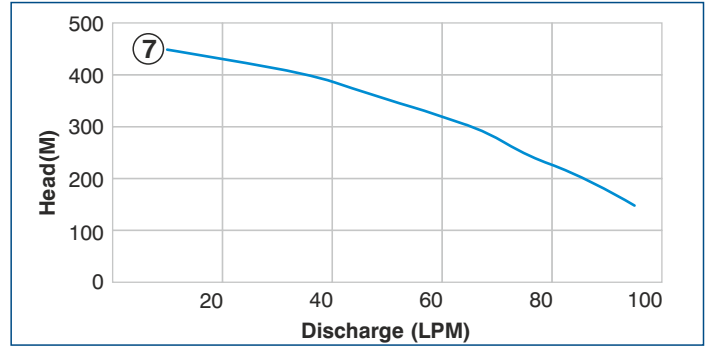
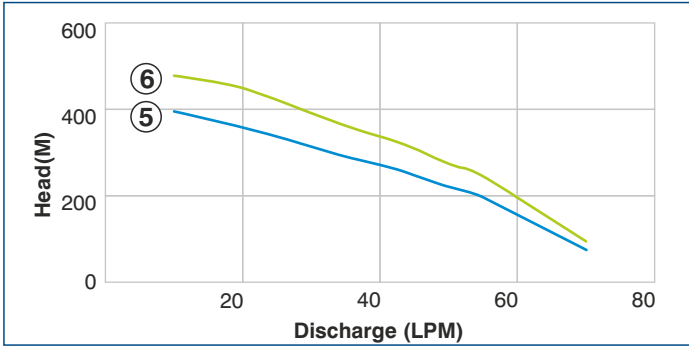
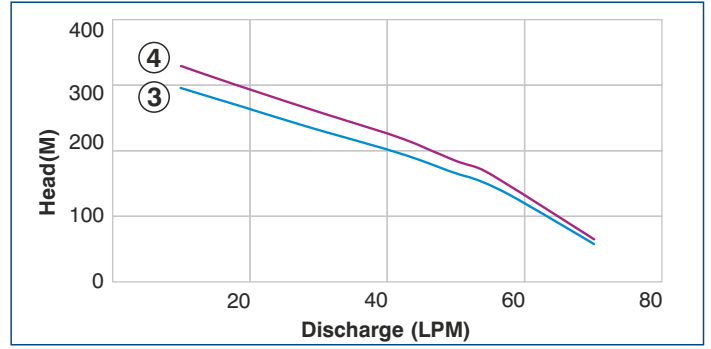
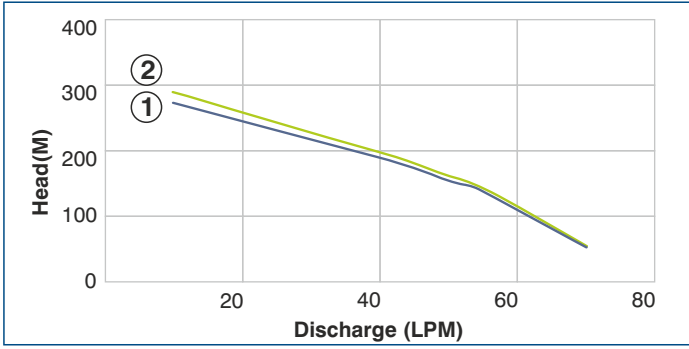

Performance Table:

| Sr. No. | Rating | No. Of Stages | Motor | | Outlet Size mm | Discharge in LPM | | | | | |
|---------|--------------|---------------|-------|----|----------------|------------------|-----|-----|-----|-----|----|
| | | | kW | HP | | 10 | 35 | 42 | 50 | 55 | 70 |
| | | | | | | Head in Meter | | | | | |
| *1 | 125W42AK5DTP | 42 | 3.7 | 5 | 32 | 274 | 204 | 185 | 155 | 139 | 55 |
| *2 | 125W44AK5DTP | 44 | 3.7 | 5 | 32 | 290 | 213 | 194 | 163 | 145 | 57 |

| Sr. No. | Rating | No. Of Stages | Motor | | Outlet Size mm | Discharge in LPM | | | | | |
|---------|--------------|---------------|-------|----|----------------|------------------|-----|-----|-----|-----|----|
| | | | kW | HP | | 10 | 35 | 42 | 50 | 55 | 70 |
| | | | | | | Head in Meter | | | | | |
| *3 | 125W45AK5DTP | 45 | 3.7 | 5 | 32 | 297 | 218 | 198 | 167 | 149 | 59 |
| *4 | 125W50AK5DTP | 50 | 3.7 | 5 | 32 | 330 | 243 | 220 | 185 | 165 | 65 |

| Sr. No. | Rating | No. Of Stages | Motor | | Outlet Size mm | Discharge in LPM | | | | | | |
|---------|-------------------|---------------|-------|-----|----------------|------------------|-----|-----|-----|-----|-----|----|
| | | | kW | HP | | 10 | 20 | 35 | 42 | 50 | 55 | 70 |
| | | | | | | Head in Meter | | | | | | |
| *5 | 125W60AK6DTP-38 | 60 | 4.5 | 6 | 38 | 396 | 360 | 292 | 264 | 222 | 198 | 78 |
| *6 | 125W75AK7.5DTP-38 | 75 | 5.5 | 7.5 | 38 | 480 | 450 | 364 | 330 | 277 | 247 | 98 |

| Sr. No. | Rating | No. Of Stages | Motor | | Outlet Size mm | Discharge in LPM | | | | | | |
|---------|-------------------|---------------|-------|-----|----------------|------------------|-----|-----|-----|-----|-----|-----|
| | | | kW | HP | | 10 | 35 | 45 | 65 | 75 | 85 | 95 |
| | | | | | | Head in Meter | | | | | | |
| *7 | 125W56AT7.5DTP-38 | 56 | 5.5 | 7.5 | 38 | 450 | 402 | 370 | 303 | 250 | 206 | 151 |

Note :

1. The motor ratings in HP are only indicative and for reference purpose
2. Performance figures given above are approximate and may differ on site conditions

3. * Marked ratings are with Noryl impeller
4. Performance mentioned on nameplate may vary as we are always improving our products

Pump Dimensional Details:

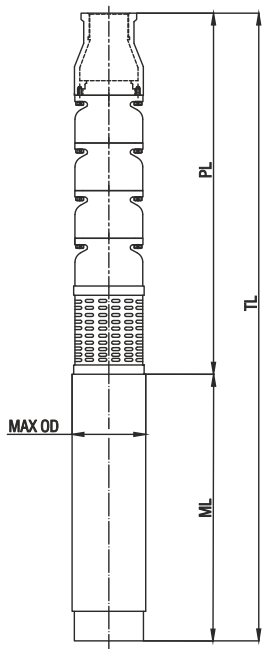

Material of Construction:

| Sr. No. | Part | Material |
|---------|---------------------------|------------------------------|
| 1 | Diffuser | Cast Iron-Grade FG 200/Noryl |
| 2 | Impeller | Stainless Steel-SS410/Noryl |
| 3 | Pump Shaft | Stainless Steel-SS410 |
| 4 | NRV Body | Cast Iron-Grade FG 200 |
| 5 | Motor Body | Stainless Steel-SS202 |
| 6 | Upper Housing, Motor Base | Cast Iron-Grade FG 200 |
| 7 | Bush | Bronze LTB-4 |
| 8 | Motor Shaft | Stainless Steel-SS420 |
| 9 | Stamping | CRNGO-M47 |
| 10 | Thrust Bearing | SS Vs Carbon |
| 11 | Strainer | Stainless Steel-SS202 |
| 12 | Fastener | Stainless Steel-SS410 |
| 13 | Sealing | Oil seal |

| All Dimensions are in mm | | | | |
|--------------------------|-----------|------|-------|------------|
| Rating | ML | PL | TL | D |
| | Length mm | | | Max. OD mm |
| | Motor | Pump | Total | |
| 5W4D5/125W4D5 | 550 | 628 | 1178 | 126.5 |
| 5W6D7.5/125W6D7.5 | 630 | 808 | 1438 | 126.5 |
| 5W8D10/125W8D10 | 700 | 988 | 1688 | 126.5 |
| 5W5C5/125W5C5 | 550 | 718 | 1268 | 126.5 |
| 5W10C10/125W10C10 | 700 | 1168 | 1868 | 126.5 |
| 125W42AK5DTP | 550 | 1602 | 2152 | 124 |
| 125W44AK5DTP | 550 | 1653 | 2203 | 124 |
| 125W45AK5DTP | 550 | 1691 | 2241 | 124 |
| 125W50AK5DTP | 550 | 1830 | 2380 | 124 |
| 125W60AK6DTP-38 | 580 | 2237 | 2817 | 124 |
| 125W75AK7.5DTP-38 | 630 | 2694 | 3324 | 124 |
| 125W56AT7.5DTP-38 | 630 | 2110 | 2740 | 124 |

5CSS Series Stainless Steel Borewell Submersible Pumps



High Grade Electrical Stampings

Reduced Electrical losses lowers the operating current of the pump



High Grade Stainless Steel

Pure SS304 stainless steel construction resists corrosion and withstand tough operating conditions



High Thrust Capacity

Specially designed thrust bearing ensures highest reliability



Wide Voltage application

Designed to withstand wide voltage fluctuations from 250V-440V & Provides Consistent Performance



Lower Operating Current

Robust Electrical Design Ensures Lower Electrical Current and Lower Power Bill



Easy For Maintenance

Easily replaceable wear & tear Parts, Low maintenance cost

Technical Specifications:

- Range: 5.0HP to 7.5HP (3.7kW to 5.5kW)
- Rated voltage: 415V for 3PH
- Voltage range: 250V - 440V for 3PH
- Rated Frequency: 50Hz
- Delivery pipe size: 32mm & 40mm
- Max. Head: Upto 405 meter
- Max. Discharge: Upto 100LPM
- Liquid: Clear water
- Motor type: Water filled motor

Application:

- Sprinkler irrigation
- Drip irrigation
- Agricultural farms
- Multistoried Buildings
- Construction sites
- Water supply for Industrial / Commercial Establishment



Performance Curve:

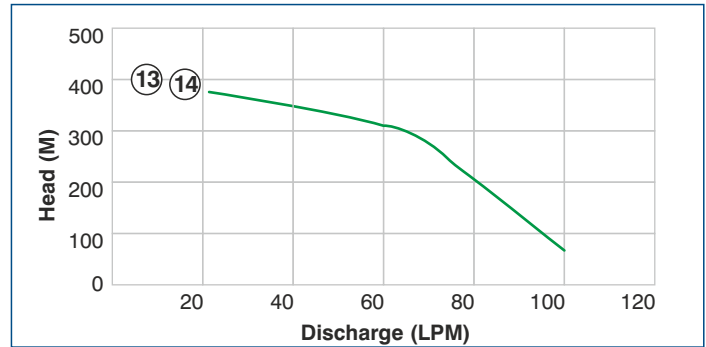
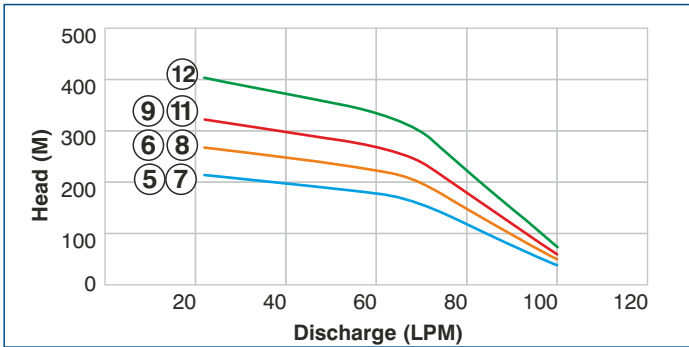
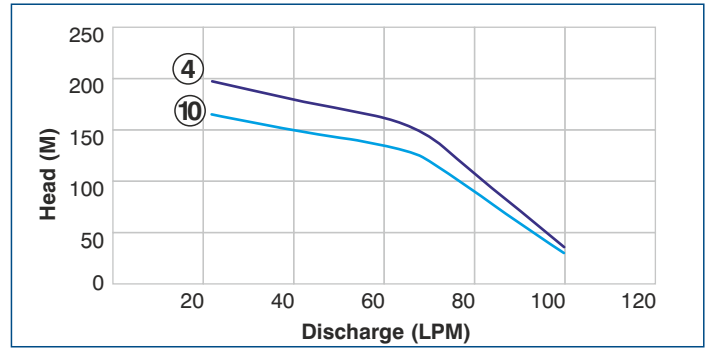
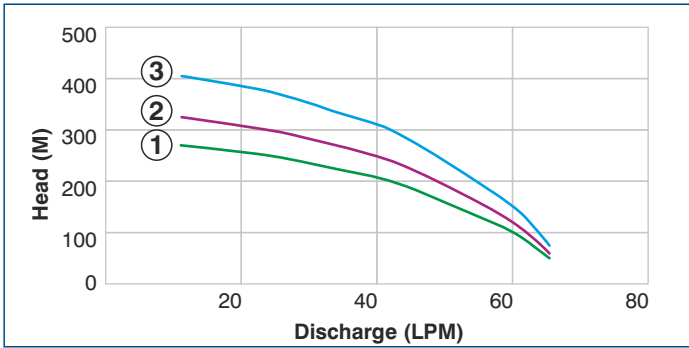

Performance Table:

| Sr. No. | Rating | No. Of Stages | Motor | | Outlet Size mm | Discharge in LPM | | | | | | |
|---------|------------------|---------------|-------|----|----------------|------------------|-----|-----|-----|-----|-----|----|
| | | | kW | HP | | 13 | 25 | 34 | 42 | 51 | 59 | 64 |
| | | | | | | Head in Meter | | | | | | |
| 1 | 5CSSF3-5050(3PH) | 50 | 3.7 | 5 | 32 | 270 | 250 | 225 | 200 | 150 | 100 | 50 |
| 2 | 5CSSF3-5060(3PH) | 60 | 3.7 | 5 | 32 | 324 | 300 | 270 | 240 | 180 | 120 | 60 |
| 3 | 5CSSF3-5075(3PH) | 75 | 3.7 | 5 | 32 | 405 | 375 | 337 | 300 | 225 | 150 | 75 |

| Sr. No. | Rating | No. Of Stages | Motor | | Outlet Size mm | Discharge in LPM | | | | | | |
|---------|------------------|---------------|-------|-----|----------------|------------------|-----|-----|-----|-----|-----|-----|
| | | | kW | HP | | 22 | 40 | 60 | 70 | 80 | 90 | 100 |
| | | | | | | Head in Meter | | | | | | |
| 4 | 5CSSF5-5036(3PH) | 36 | 3.7 | 5.0 | 40 | 198 | 180 | 162 | 144 | 108 | 72 | 36 |
| 5 | 5CSSF5-5040(3PH) | 40 | 3.7 | 5.0 | 40 | 216 | 200 | 180 | 160 | 120 | 80 | 40 |
| 6 | 5CSSF5-5050(3PH) | 50 | 3.7 | 5.0 | 40 | 270 | 250 | 225 | 200 | 150 | 100 | 50 |
| 7 | 5CSSF5-6040(3PH) | 40 | 4.0 | 6.0 | 40 | 216 | 200 | 180 | 160 | 120 | 80 | 40 |
| 8 | 5CSSF5-6050(3PH) | 50 | 4.0 | 6.0 | 40 | 270 | 250 | 225 | 200 | 150 | 100 | 50 |
| 9 | 5CSSF5-6060(3PH) | 60 | 4.0 | 6.0 | 40 | 324 | 300 | 270 | 240 | 180 | 120 | 60 |
| 10 | 5CSSF5-7530(3PH) | 30 | 5.5 | 7.5 | 40 | 165 | 150 | 135 | 120 | 90 | 60 | 30 |
| 11 | 5CSSF5-7560(3PH) | 60 | 5.5 | 7.5 | 40 | 324 | 300 | 270 | 240 | 180 | 120 | 60 |
| 12 | 5CSSF5-7575(3PH) | 75 | 5.5 | 7.5 | 40 | 405 | 375 | 338 | 300 | 225 | 150 | 75 |

| Sr. No. | Rating | No. Of Stages | Motor | | Outlet Size mm | Discharge in LPM | | | | | | |
|---------|------------------|---------------|-------|-----|----------------|------------------|-----|-----|-----|-----|-----|-----|
| | | | kW | HP | | 22 | 40 | 60 | 70 | 80 | 90 | 100 |
| | | | | | | Head in Meter | | | | | | |
| 13 | 5CSSF5-1075(3PH) | 75 | 7.5 | 10 | 40 | 405 | 375 | 338 | 300 | 225 | 150 | 75 |
| 14 | 5CSSF5-7575(3PH) | 75 | 5.5 | 7.5 | 40 | 405 | 375 | 338 | 300 | 225 | 150 | 75 |

Note :

1. The motor ratings in HP are only indicative and for reference purpose
2. Performance figures given above are approximate and may differ on site conditions

3. Performance mentioned on nameplate may vary as we are always improving our products

Material of Construction:

| No. | Part | Material |
|-----|-------------------------|-------------------------|
| 1 | Diffuser | Stainless steel - SS304 |
| 2 | Impeller | Stainless steel - SS304 |
| 3 | Pump Shaft | Stainless steel - SS410 |
| 4 | NRV Body | Stainless steel - SS304 |
| 5 | Motor Body | Stainless steel - SS202 |
| 6 | Suction Housing/Adaptor | Stainless steel - SS304 |
| 7 | Upper and Lower Housing | Cast Iron Gr FG 200 |
| 8 | Motor Base | Cast Iron Gr FG 200 |
| 9 | Bush | Bronze, LTB-4 |
| 10 | Motor Shaft | Stainless steel - SS420 |
| 11 | Stamping | CRNGO – M47 |
| 12 | Thrust Bearing | SS Vs Carbon |
| 13 | Strainer | Stainless steel - SS304 |
| 14 | Sealing | Oil seal |

Pump Dimensional Details:

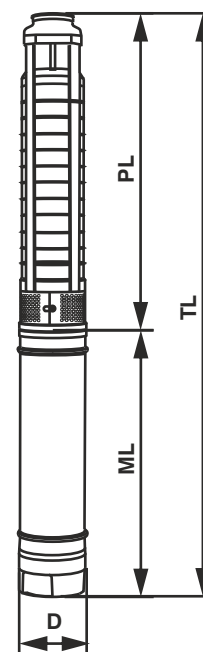

| All Dimensions are in mm | | | | |
|--------------------------|-----------|------|-------|------------|
| Rating | ML | PL | TL | D |
| | Length mm | | | Max. OD mm |
| | Motor | Pump | Total | |
| 5CSSF3-5050(3PH) | 679 | 1393 | 2034 | 125 |
| 5CSSF3-5060(3PH) | 679 | 1621 | 2262 | 125 |
| 5CSSF3-5075(3PH) | 679 | 1993 | 2634 | 125 |
| 5CSSF5-5030(3PH) | 679 | 907 | 1548 | 125 |
| 5CSSF5-5036(3PH) | 679 | 1044 | 1685 | 125 |
| 5CSSF5-5040(3PH) | 679 | 1135 | 1776 | 125 |
| 5CSSF5-5050(3PH) | 679 | 1393 | 2034 | 125 |
| 5CSSF5-6040(3PH) | 709 | 1135 | 1806 | 125 |
| 5CSSF5-6050(3PH) | 709 | 1393 | 2064 | 125 |
| 5CSSF5-6060(3PH) | 709 | 1621 | 2292 | 125 |
| 5CSSF5-7530(3PH) | 709 | 907 | 1578 | 125 |
| 5CSSF5-7560(3PH) | 709 | 1621 | 2292 | 125 |
| 5CSSF5-7575(3PH) | 709 | 1993 | 2664 | 125 |
| 5CSSF5-1075(3PH) | 880 | 2225 | 3105 | 149 |
| 5CSSF5-7575(3PH) | 773 | 1984 | 2757 | 121 |

6W Ultima Series Borewell Submersible Pumps



High Grade Electrical Stampings

Reduced Electrical losses lowers the operating current of the pump



Wide Voltage application

Designed to withstand wide voltage fluctuations from 250V-440V & Provides Consistent Performance



Lower Operating Current

Robust Electrical Design Ensures Lower Electrical Current and Lower Power Bill



High Thrust Capacity

Specially designed thrust bearing ensures highest reliability



Easy For Maintenance

Easily replaceable wear & tear Parts, Low maintenance cost

Technical Specifications:

- Range: 3HP to 12.5 HP (2.2 kW to 9.3 kW)
- Rated Voltage: 415V for 3PH
- Voltage Range: 250-440V
- Rated Frequency: 50Hz
- Pipe Size: 50mm to 75mm
- Max. head: Up to 315 Meters.
- Max. Discharge: Up to 1200 LPM.
- Liquid: Clear Water
- Rotation: Anticlockwise

Application:

- Sprinkler irrigation
- Drip irrigation
- Agricultural farms
- Multistoried Buildings
- Construction sites
- Water supply for Industrial / Commercial Establishment
- Lawn Sprinklers



Performance Curve:

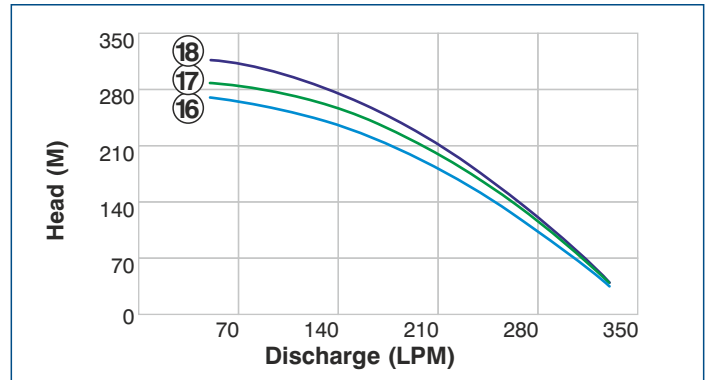
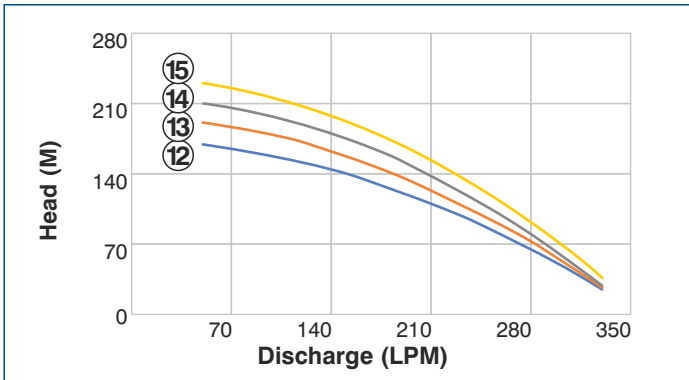
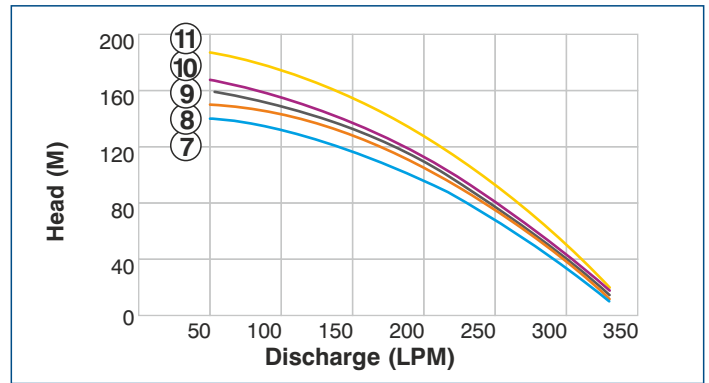
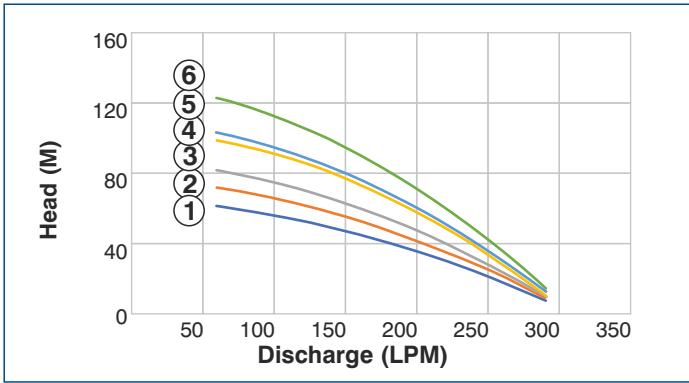

Performance Table:

| Sr. No. | Rating | Stages | Motor | | Pipe Size mm | Discharge in LPM | | | | | | |
|---------|----------|--------|-------|-----|--------------|------------------|-----|-----|-----|-----|-----|-----|
| | | | kW | HP | | Head in Meter | | | | | | |
| | | | | | | 60 | 100 | 150 | 170 | 200 | 250 | 290 |
| 1 | 6W6W3DU | 6 | 2.2 | 3.0 | 50 | 61 | 56 | 47 | 44 | 35 | 21 | 8 |
| 2 | 6W7W3DU | 7 | 2.2 | 3.0 | 50 | 72 | 65 | 54 | 51 | 41 | 25 | 9 |
| 3 | 6W8W3DU | 8 | 2.2 | 3.0 | 50 | 82 | 75 | 62 | 58 | 47 | 28 | 10 |
| 4 | 6W10W4DU | 10 | 3.0 | 4.0 | 50 | 99 | 90 | 76 | 70 | 58 | 34 | 10 |
| 5 | 6W10W5DU | 10 | 3.7 | 5.0 | 50 | 103 | 94 | 79 | 73 | 61 | 36 | 12 |
| 6 | 6W12W5DU | 12 | 3.7 | 5.0 | 50 | 123 | 112 | 93 | 87 | 71 | 43 | 14 |

| Sr. No. | Rating | Stages | Motor | | Pipe Size mm | Discharge in LPM | | | | | | |
|---------|------------|--------|-------|-----|--------------|------------------|-----|-----|-----|-----|-----|-----|
| | | | kW | HP | | Head in Meter | | | | | | |
| | | | | | | 50 | 100 | 150 | 200 | 250 | 300 | 330 |
| 7 | 6W13W6DU | 13 | 4.5 | 6.0 | 50 | 140 | 132 | 120 | 95 | 65 | 35 | 10 |
| 8 | 6W14W7.5DU | 14 | 5.5 | 7.5 | 50 | 150 | 142 | 130 | 105 | 72 | 38 | 13 |
| 9 | 6W15W6DU | 15 | 4.5 | 6.0 | 50 | 160 | 150 | 134 | 110 | 76 | 40 | 16 |
| 10 | 6W16W7.5DU | 16 | 5.5 | 7.5 | 50 | 168 | 155 | 135 | 115 | 81 | 43 | 18 |
| 11 | 6W18W7.5DU | 18 | 5.5 | 7.5 | 50 | 186 | 176 | 154 | 128 | 90 | 50 | 20 |

| Sr. No. | Rating | Stages | Motor | | Pipe Size mm | Discharge in LPM | | | | | | |
|---------|-------------|--------|-------|------|--------------|------------------|-----|-----|-----|-----|-----|-----|
| | | | kW | HP | | Head in Meter | | | | | | |
| | | | | | | 50 | 100 | 150 | 200 | 250 | 300 | 330 |
| 12 | 6W16W10DU | 16 | 7.5 | 10.0 | 50 | 170 | 160 | 136 | 116 | 90 | 49 | 23 |
| 13 | 6W18W10DU | 18 | 7.5 | 10.0 | 50 | 190 | 180 | 153 | 130 | 100 | 53 | 25 |
| 14 | 6W20W10DU | 20 | 7.5 | 10.0 | 50 | 210 | 200 | 170 | 145 | 110 | 59 | 28 |
| 15 | 6W22W10DU | 22 | 7.5 | 10.0 | 50 | 230 | 218 | 192 | 162 | 121 | 72 | 36 |
| 16 | 6W24W12.5DU | 24 | 9.3 | 12.5 | 50 | 270 | 253 | 232 | 193 | 138 | 73 | 39 |
| 17 | 6W26W12.5DU | 26 | 9.3 | 12.5 | 50 | 290 | 270 | 250 | 215 | 155 | 82 | 42 |
| 18 | 6W28W12.5DU | 28 | 9.3 | 12.5 | 50 | 315 | 295 | 270 | 225 | 160 | 85 | 45 |

Performance Curve:

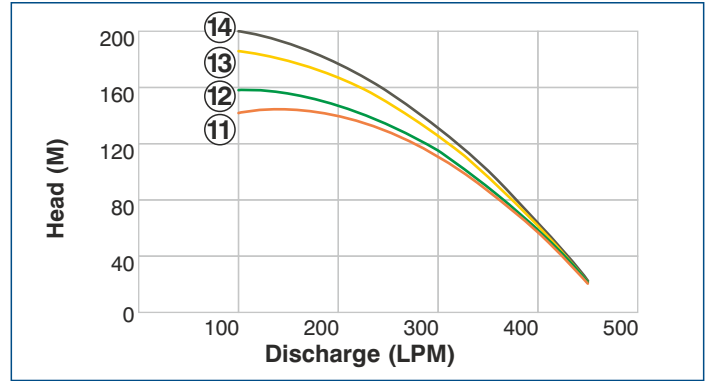
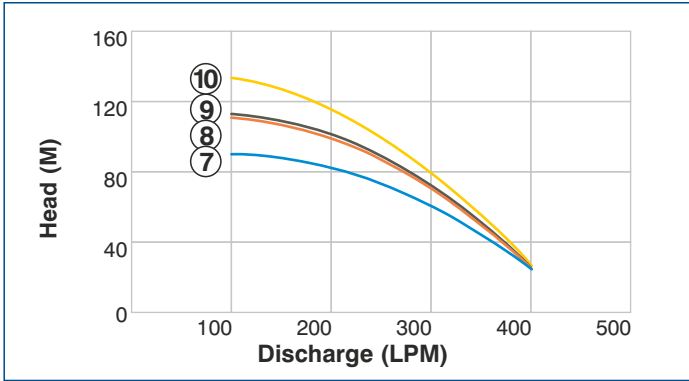
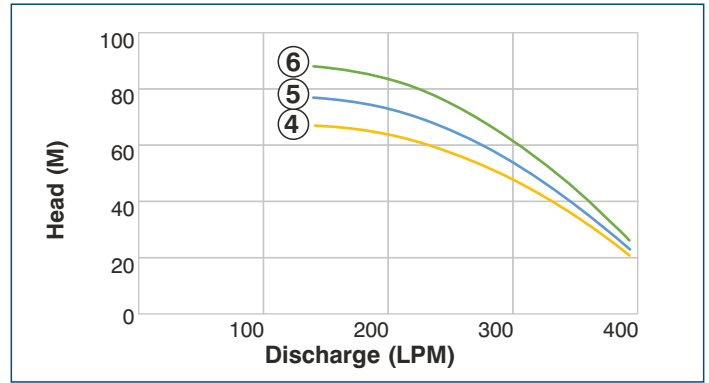
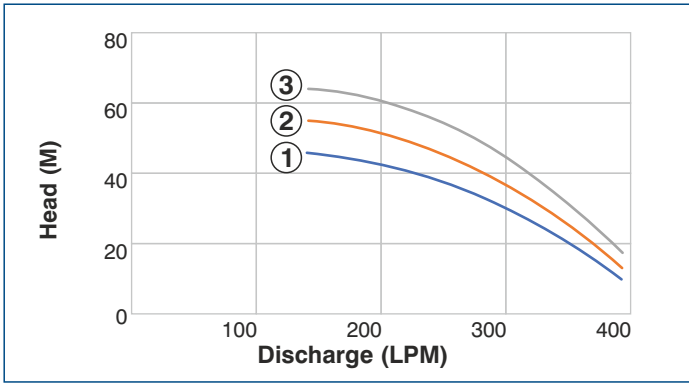

Performance Table:

| Sr. No. | Rating | Stages | Motor | | Pipe Size mm | Discharge in LPM | | | | | | | | |
|---------|---------|--------|-------|-----|--------------|------------------|----|---------------|-----|-----|-----|-----|-----|-----|
| | | | | | | kW | HP | 130 | 190 | 240 | 280 | 310 | 350 | 390 |
| | | | | | | | | Head in Meter | | | | | | |
| 1 | 6W4J3DU | 4 | 2.2 | 3.0 | 50 | 44 | 42 | 37 | 33 | 29 | 22 | 13 | | |
| 2 | 6W5J3DU | 5 | 2.2 | 3.0 | 50 | 55 | 53 | 46 | 41 | 36 | 28 | 16 | | |
| 3 | 6W6J4DU | 6 | 3.0 | 4.0 | 50 | 64 | 61 | 54 | 48 | 41 | 30 | 18 | | |
| 4 | 6W6J5DU | 6 | 3.7 | 5.0 | 50 | 67 | 64 | 57 | 51 | 44 | 34 | 21 | | |
| 5 | 6W7J5DU | 7 | 3.7 | 5.0 | 50 | 77 | 74 | 65 | 58 | 50 | 39 | 23 | | |
| 6 | 6W8J5DU | 8 | 3.7 | 5.0 | 50 | 88 | 84 | 74 | 66 | 57 | 44 | 26 | | |

| Sr. No. | Rating | Stages | Motor | | Pipe Size mm | Discharge in LPM | | | | | | | | |
|---------|------------|--------|-------|-----|--------------|------------------|-----|---------------|-----|-----|-----|-----|-----|-----|
| | | | | | | kW | HP | 100 | 150 | 200 | 250 | 300 | 350 | 400 |
| | | | | | | | | Head in Meter | | | | | | |
| 7 | 6W8J6DU | 8 | 4.5 | 6.0 | 50 | 90 | 87 | 84 | 71 | 60 | 46 | 24 | | |
| 8 | 6W10J6DU | 10 | 4.5 | 6.0 | 50 | 110 | 107 | 100 | 86 | 69 | 50 | 25 | | |
| 9 | 6W10J7.5DU | 10 | 5.5 | 7.5 | 50 | 112 | 109 | 102 | 88 | 71 | 52 | 26 | | |
| 10 | 6W12J7.5DU | 12 | 5.5 | 7.5 | 50 | 132 | 127 | 114 | 98 | 80 | 54 | 27 | | |

| Sr. No. | Rating | Stages | Motor | | Pipe Size mm | Discharge in LPM | | | | | | | | | |
|---------|-------------|--------|-------|------|--------------|------------------|-----|---------------|-----|-----|-----|-----|-----|-----|-----|
| | | | | | | kW | HP | 100 | 150 | 200 | 250 | 300 | 350 | 400 | 450 |
| | | | | | | | | Head in Meter | | | | | | | |
| 11 | 6W13J10DU | 13 | 7.5 | 10.0 | 50 | 145 | 142 | 139 | 130 | 110 | 90 | 57 | 20 | | |
| 12 | 6W14J10DU | 14 | 7.5 | 10.0 | 50 | 160 | 156 | 145 | 135 | 113 | 92 | 60 | 21 | | |
| 13 | 6W16J12.5DU | 16 | 9.3 | 12.5 | 50 | 185 | 180 | 170 | 150 | 125 | 94 | 62 | 23 | | |
| 14 | 6W18J12.5DU | 18 | 9.3 | 12.5 | 50 | 200 | 190 | 180 | 160 | 130 | 96 | 65 | 24 | | |

Performance Curve:

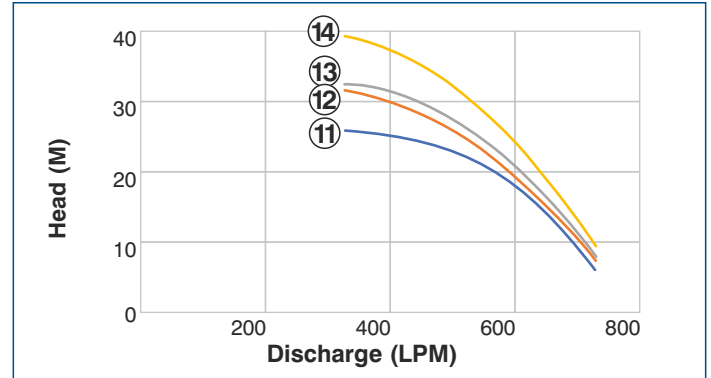
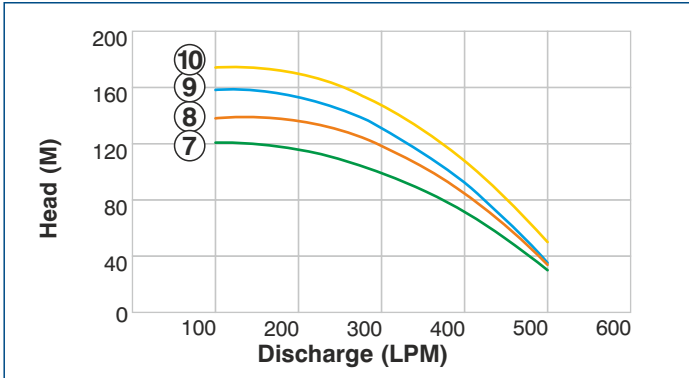
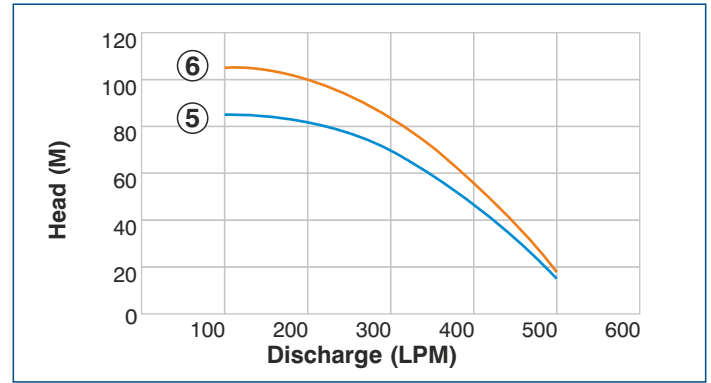
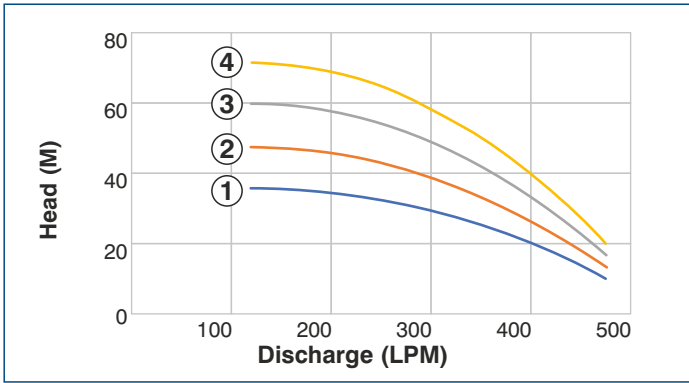

Performance Table:

| Sr. No. | Rating | Stages | Motor | | Pipe Size mm | Discharge in LPM | | | | | | |
|---------|---------|--------|-------|-----|--------------|------------------|-----|-----|-----|-----|-----|-----|
| | | | | | | 120 | 180 | 240 | 310 | 350 | 400 | 475 |
| | | | kW | HP | | Head in Meter | | | | | | |
| 1 | 6W3R3DU | 3 | 2.2 | 3.0 | 50 | 36 | 35 | 33 | 29 | 25 | 20 | 10 |
| 2 | 6W4R4DU | 4 | 3.0 | 4.0 | 50 | 48 | 47 | 43 | 39 | 33 | 27 | 13 |
| 3 | 6W5R5DU | 5 | 3.7 | 5.0 | 50 | 60 | 58 | 54 | 48 | 42 | 33 | 17 |
| 4 | 6W6R5DU | 6 | 3.7 | 5.0 | 50 | 72 | 70 | 65 | 58 | 50 | 40 | 20 |

| Sr. No. | Rating | Stages | Motor | | Pipe Size mm | Discharge in LPM | | | | | | |
|---------|-----------|--------|-------|-----|--------------|------------------|-----|-----|-----|-----|-----|-----|
| | | | | | | 100 | 200 | 250 | 300 | 350 | 400 | 500 |
| | | | kW | HP | | Head in Meter | | | | | | |
| 5 | 6W7R6DU | 7 | 4.5 | 6.0 | 50 | 85 | 82 | 77 | 70 | 60 | 48 | 15 |
| 6 | 6W9R7.5DU | 9 | 5.5 | 7.5 | 50 | 106 | 100 | 94 | 84 | 72 | 57 | 18 |

| Sr. No. | Rating | Stages | Motor | | Pipe Size mm | Discharge in LPM | | | | | | |
|---------|-------------|--------|-------|------|--------------|------------------|-----|-----|-----|-----|-----|-----|
| | | | | | | 100 | 200 | 250 | 300 | 350 | 400 | 500 |
| | | | kW | HP | | Head in Meter | | | | | | |
| 7 | 6W10R10DU | 10 | 7.5 | 10.0 | 50 | 120 | 115 | 110 | 100 | 85 | 70 | 30 |
| 8 | 6W11R10DU | 11 | 7.5 | 10.0 | 50 | 140 | 133 | 130 | 120 | 105 | 85 | 33 |
| 9 | 6W12R12.5DU | 12 | 9.3 | 12.5 | 50 | 160 | 150 | 145 | 135 | 115 | 90 | 35 |
| 10 | 6W14R12.5DU | 14 | 9.3 | 12.5 | 50 | 175 | 168 | 160 | 150 | 130 | 108 | 50 |

| Sr. No. | Rating | Stages | Motor | | Pipe Size mm | Discharge in LPM | | | | | | |
|---------|---------|--------|-------|-----|--------------|------------------|-----|-----|-----|-----|-----|-----|
| | | | | | | 330 | 450 | 500 | 600 | 650 | 700 | 730 |
| | | | kW | HP | | Head in Meter | | | | | | |
| 11 | 6W3D3DU | 3 | 2.2 | 3.0 | 65 | 26 | 22 | 20 | 16 | 14 | 10 | 5 |
| 12 | 6W4D3DU | 4 | 2.2 | 3.0 | 65 | 32 | 27 | 26 | 20 | 16 | 11 | 6 |
| 13 | 6W4D4DU | 4 | 3.0 | 4.0 | 65 | 33 | 29 | 27 | 22 | 17 | 12 | 7 |
| 14 | 6W5D5DU | 5 | 3.7 | 5.0 | 65 | 40 | 34 | 32 | 25 | 20 | 14 | 8 |

Performance Curve:

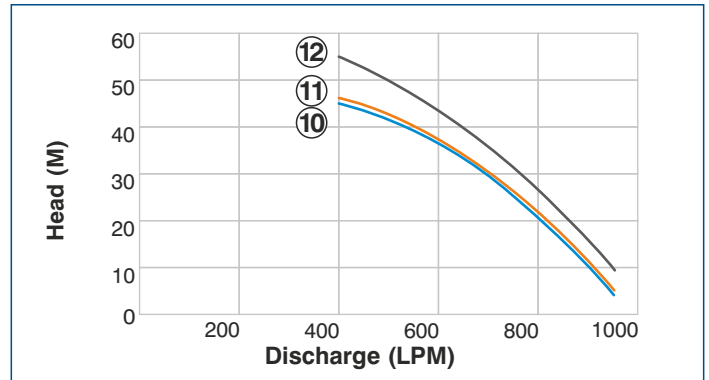
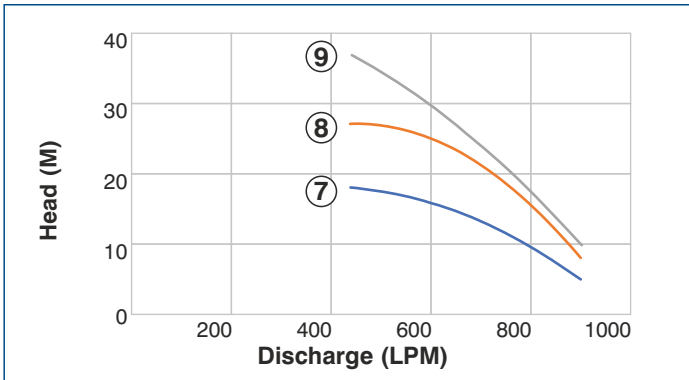
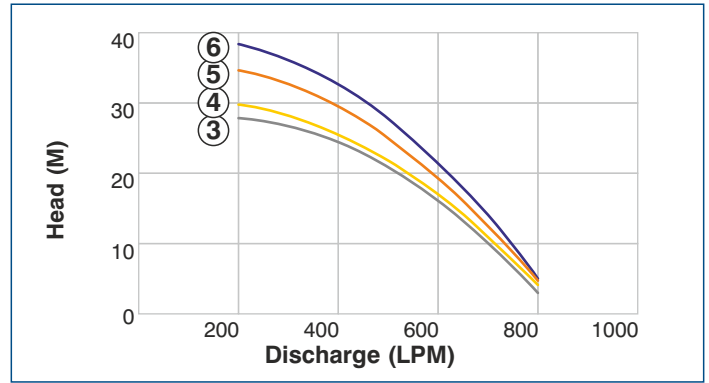
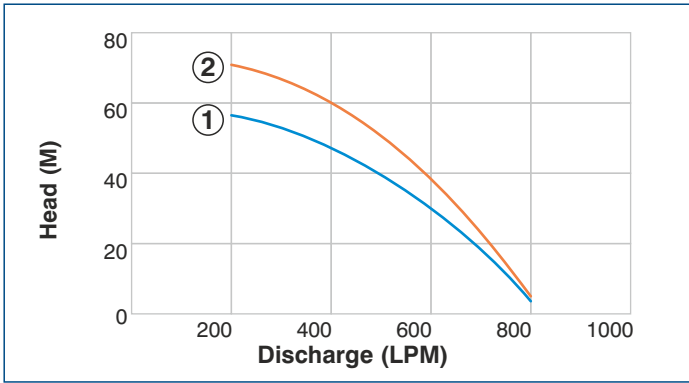

Performance Table:

| Sr. No. | Rating | Stages | Motor | | Pipe Size mm | Discharge in LPM | | | | | | |
|---------|-----------|--------|-------|-----|--------------|------------------|-----|-----|-----|-----|-----|-----|
| | | | kW | HP | | 200 | 300 | 400 | 500 | 600 | 700 | 800 |
| | | | | | | Head In Meter | | | | | | |
| 1 | 6W6D6DU | 6 | 4.5 | 6.0 | 65 | 57 | 53 | 47 | 40 | 30 | 19 | 4 |
| 2 | 6W8D7.5DU | 8 | 5.5 | 7.5 | 65 | 72 | 66 | 60 | 51 | 40 | 23 | 6 |

| Sr. No. | Rating | Stages | Motor | | Pipe Size mm | Discharge in LPM | | | | | | |
|---------|-------------|--------|-------|------|--------------|------------------|-----|-----|-----|-----|-----|-----|
| | | | kW | HP | | 200 | 300 | 400 | 500 | 600 | 700 | 800 |
| | | | | | | Head In Meter | | | | | | |
| 3 | 6W9D10DU | 9 | 7.5 | 10.0 | 65 | 85 | 79 | 72 | 62 | 50 | 33 | 7 |
| 4 | 6W10D10DU | 10 | 7.5 | 10.0 | 65 | 91 | 83 | 75 | 65 | 52 | 35 | 10 |
| 5 | 6W11D12.5DU | 11 | 9.3 | 12.5 | 65 | 105 | 97 | 88 | 75 | 58 | 39 | 13 |
| 6 | 6W12D12.5DU | 12 | 9.3 | 12.5 | 65 | 116 | 108 | 97 | 84 | 66 | 42 | 15 |

| Sr. No. | Rating | Stages | Motor | | Pipe Size mm | Discharge in LPM | | | | | |
|---------|---------|--------|-------|-----|--------------|------------------|-----|-----|-----|-----|-----|
| | | | kW | HP | | 440 | 650 | 700 | 780 | 840 | 900 |
| | | | | | | Head In Meter | | | | | |
| 7 | 6W2F3DU | 2 | 2.2 | 3.0 | 75 | 18 | 15 | 13 | 10 | 8 | 5 |
| 8 | 6W3F5DU | 3 | 3.7 | 5.0 | 75 | 27 | 24 | 21 | 16 | 13 | 8 |
| 9 | 6W4F5DU | 4 | 3.7 | 5.0 | 75 | 37 | 27 | 24 | 19 | 14 | 10 |

| Sr. No. | Rating | Stages | Motor | | Pipe Size mm | Discharge in LPM | | | | | | |
|---------|-----------|--------|-------|-----|--------------|------------------|-----|-----|-----|-----|-----|-----|
| | | | kW | HP | | 400 | 500 | 600 | 700 | 800 | 900 | 950 |
| | | | | | | Head in Meter | | | | | | |
| 10 | 6W5F6DU | 5 | 4.5 | 6.0 | 75 | 45 | 42 | 38 | 29 | 20 | 10 | 5 |
| 11 | 6W5F7.5DU | 5 | 5.5 | 7.5 | 75 | 46 | 43 | 39 | 30 | 21 | 11 | 6 |
| 12 | 6W6F7.5DU | 6 | 5.5 | 7.5 | 75 | 55 | 50 | 44 | 36 | 27 | 15 | 10 |

Performance Curve:

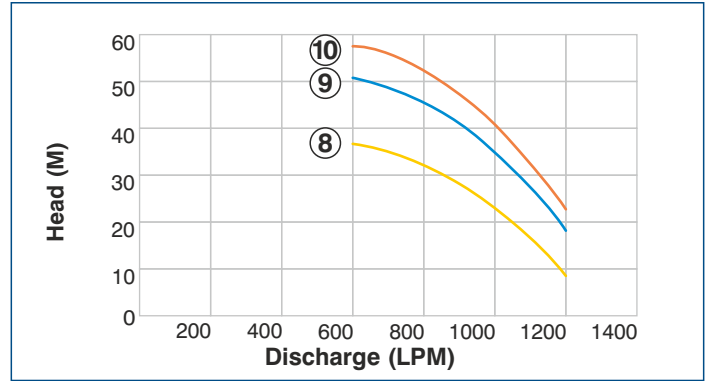
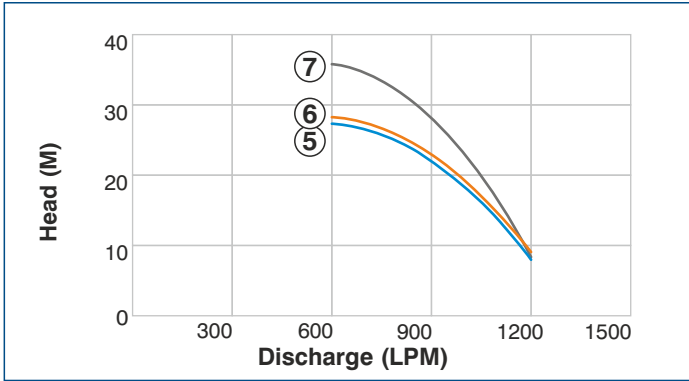
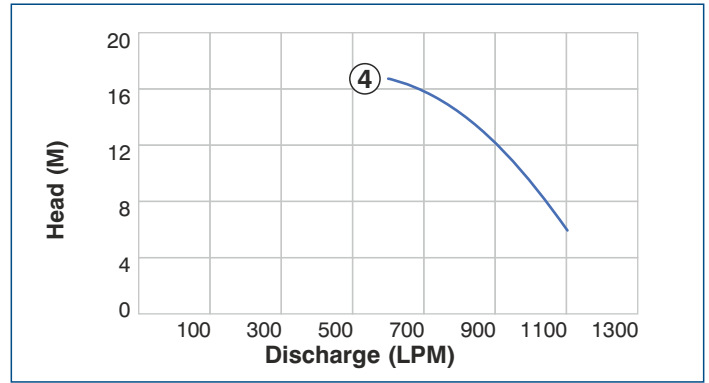
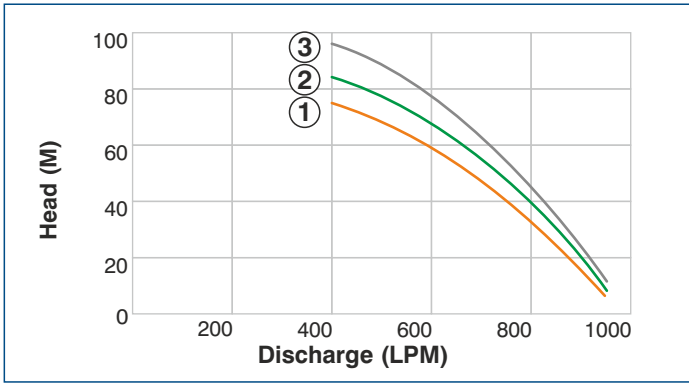

Performance Table:

| Sr. No. | Rating | Stages | Motor | | Pipe Size mm | Discharge in LPM | | | | | | |
|---------|-------------|--------|-------|------|--------------|------------------|-----|-----|-----|-----|-----|-----|
| | | | kW | HP | | 400 | 500 | 600 | 700 | 800 | 900 | 950 |
| | | | | | | Head in Meter | | | | | | |
| 1 | 6W8F10DU | 8 | 7.5 | 10.0 | 75 | 75 | 68 | 60 | 47 | 33 | 15 | 7 |
| 2 | 6W9F12.5DU | 9 | 9.3 | 12.5 | 75 | 85 | 78 | 69 | 55 | 40 | 20 | 10 |
| 3 | 6W10F12.5DU | 10 | 9.3 | 12.5 | 75 | 96 | 88 | 78 | 63 | 45 | 23 | 12 |

| Sr. No. | Rating | Stages | Motor | | Pipe Size mm | Discharge in LPM | | | | | |
|---------|---------|--------|-------|-----|--------------|------------------|-----|-----|-----|------|------|
| | | | kW | HP | | 650 | 720 | 804 | 930 | 1020 | 1100 |
| | | | | | | Head in Meter | | | | | |
| 4 | 6W2H5DU | 2 | 3.7 | 5.0 | 75 | 17 | 16 | 15 | 12 | 9 | 6 |

| Sr. No. | Rating | Stages | kW / HP | | Pipe Size mm | Discharge in LPM | | | | | | |
|---------|-----------|--------|---------|-----|--------------|------------------|-----|-----|-----|------|------|------|
| | | | kW | HP | | 600 | 700 | 800 | 900 | 1000 | 1100 | 1200 |
| | | | | | | Head in Meter | | | | | | |
| 5 | 6W3H6DU | 3 | 4.5 | 6.0 | 75 | 28 | 26 | 24 | 22 | 19 | 14 | 7 |
| 6 | 6W3H7.5DU | 3 | 5.5 | 7.5 | 75 | 29 | 27 | 25 | 23 | 20 | 15 | 8 |
| 7 | 6W4H7.5DU | 4 | 5.5 | 7.5 | 75 | 36 | 34 | 32 | 29 | 22 | 16 | 8 |

| Sr. No. | Rating | Stages | Motor | | Pipe Size mm | Discharge in LPM | | | | | | |
|---------|------------|--------|-------|------|--------------|------------------|-----|-----|-----|------|------|------|
| | | | kW | HP | | 600 | 700 | 800 | 900 | 1000 | 1100 | 1200 |
| | | | | | | Head in Meter | | | | | | |
| 8 | 6W4H10DU | 4 | 7.5 | 10.0 | 75 | 37 | 35 | 32 | 28 | 23 | 17 | 8 |
| 9 | 6W5H12.5DU | 5 | 9.3 | 12.5 | 75 | 51 | 48 | 45 | 41 | 35 | 27 | 18 |
| 10 | 6W6H12.5DU | 6 | 9.3 | 12.5 | 75 | 58 | 55 | 52 | 48 | 40 | 33 | 22 |

Note :

1. The motor ratings in HP are only indicative and for reference purpose
2. Performance figures given above are approximate and may differ on site conditions

3. Performance mentioned on nameplate may vary as we are always improving our products

Material of Construction:

| Sr. No. | Part | Material |
|---------|-----------------------------------|---|
| 1 | Bowl | Cast Iron- Grade FG 200 |
| 2 | Impeller | Noryl for Radial Flow Pump / Stainless steel (SS410) for Mixed Flow Pump |
| 3 | Pump/Motor Shaft | Stainless Steel- SS410 |
| 4 | NRV | Cast Iron - Grade FG 200 |
| 5 | Suction Housing | Cast Iron - Grade FG 200 |
| 6 | Motor Body | Stainless Steel- SS202 |
| 7 | Upper & Lower Housing, Motor Base | Cast Iron - Grade FG 200 |
| 8 | Stamping | CRNGO - M47 |
| 9 | Bearing Bush | Bronze LTB-4 |
| 10 | Thrust Bearing | Carbon Vs SS |
| 11 | Fasteners | Stainless Steel- SS410 |
| 12 | Strainer | Stainless Steel - SS202 |
| 13 | Sealing | Oil Seal |

Pump Dimensional Details:

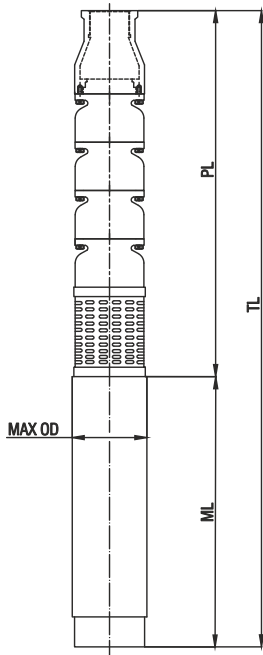

| All Dimensions are in mm | | | | |
|--------------------------|-----------|------|-------|-----------------|
| Rating | ML | PL | TL | D Max. OD mm |
| | Length mm | | | |
| | Motor | Pump | Total | |
| 6W6W3DU | 509 | 852 | 1361 | 143.5 |
| 6W7W3DU | 509 | 892 | 1401 | 143.5 |
| 6W8W3DU | 509 | 932 | 1441 | 143.5 |
| 6W10W4DU | 509 | 972 | 1481 | 143.5 |
| 6W10W5DU | 535 | 972 | 1507 | 143.5 |
| 6W12W5DU | 535 | 1012 | 1547 | 143.5 |
| 6W13W6DU | 671 | 1234 | 1905 | 143.5 |
| 6W14W7.5DU | 721 | 1274 | 1995 | 143.5 |
| 6W15W6DU | 671 | 1314 | 1985 | 143.5 |
| 6W16W7.5DU | 721 | 1354 | 2075 | 143.5 |
| 6W18W7.5DU | 721 | 1434 | 2155 | 143.5 |
| 6W22W10DU | 504 | 1492 | 1996 | 143.5 |
| 6W20W10DU | 504 | 1412 | 1916 | 143.5 |
| 6W18W10DU | 504 | 1332 | 1836 | 143.5 |
| 6W16W10DU | 504 | 1292 | 1796 | 143.5 |
| 6W28W12.5DU | 766 | 1732 | 2498 | 143.5 |
| 6W26W12.5DU | 766 | 1652 | 2418 | 143.5 |
| 6W4J3DU | 509 | 485 | 994 | 143.5 |
| 6W5J3DU | 509 | 525 | 1034 | 143.5 |
| 6W6J4DU | 509 | 565 | 1074 | 143.5 |
| 6W6J5DU | 535 | 565 | 1100 | 143.5 |
| 6W7J5DU | 535 | 605 | 1140 | 143.5 |

| All Dimensions are in mm | | | | |
|--------------------------|-----------|------|-------|------------|
| Rating | ML | PL | TL | D |
| | Length mm | | | Max. OD mm |
| | Motor | Pump | Total | |
| 6W8J5DU | 535 | 605 | 1140 | 143.5 |
| 6W8J6DU | 671 | 707 | 1378 | 143.5 |
| 6W10J6DU | 671 | 807 | 1478 | 143.5 |
| 6W10J7.5DU | 721 | 807 | 1528 | 143.5 |
| 6W12J7.5DU | 721 | 907 | 1628 | 143.5 |
| 6W14J10DU | 504 | 885 | 1389 | 143.5 |
| 6W13J10DU | 504 | 845 | 1349 | 143.5 |
| 6W18J12.5DU | 766 | 1045 | 1811 | 143.5 |
| 6W16J12.5DU | 766 | 965 | 1731 | 143.5 |
| 6W3R3DU | 509 | 427 | 936 | 143.5 |
| 6W4R4DU | 509 | 467 | 976 | 143.5 |
| 6W5R5DU | 535 | 507 | 1042 | 143.5 |
| 6W6R5DU | 535 | 547 | 1082 | 143.5 |
| 6W7R6DU | 671 | 689 | 1360 | 143.5 |
| 6W9R7.5DU | 721 | 769 | 1490 | 143.5 |
| 6W11R10DU | 504 | 747 | 1251 | 143.5 |
| 6W10R10DU | 504 | 707 | 1211 | 143.5 |
| 6W14R12.5DU | 766 | 867 | 1633 | 143.5 |
| 6W12R12.5DU | 766 | 787 | 1553 | 143.5 |
| 6W3D3DU | 509 | 548 | 1057 | 143.5 |
| 6W4D3DU | 509 | 638 | 1147 | 143.5 |
| 6W4D4DU | 509 | 638 | 1147 | 143.5 |
| 6W5D5DU | 535 | 728 | 1263 | 143.5 |

| All Dimensions are in mm | | | | |
|--------------------------|-----------|------|-------|------------|
| Rating | ML | PL | TL | D |
| | Length mm | | | Max. OD mm |
| | Motor | Pump | Total | |
| 6W6D6DU | 671 | 919 | 1590 | 143.5 |
| 6W8D7.5DU | 721 | 1099 | 1820 | 143.5 |
| 6W10D10DU | 504 | 1268 | 1772 | 143.5 |
| 6W9D10DU | 504 | 1178 | 1682 | 143.5 |
| 6W8F10DU | 504 | 1195 | 1699 | 143.5 |
| 6W4H10DU | 504 | 700 | 1204 | 143.5 |
| 6W12D12.5DU | 766 | 1448 | 2214 | 143.5 |
| 6W11D12.5DU | 766 | 1355 | 2121 | 143.5 |
| 6W2F3DU | 509 | 495 | 1004 | 143.5 |
| 6W3F5DU | 535 | 595 | 1130 | 143.5 |
| 6W4F5DU | 535 | 695 | 1230 | 143.5 |
| 6W5F6DU | 671 | 897 | 1567 | 143.5 |
| 6W5F7.5DU | 721 | 897 | 1618 | 143.5 |
| 6W6F7.5DU | 721 | 997 | 1718 | 143.5 |
| 6W10F12.5DU | 766 | 1395 | 2161 | 143.5 |
| 6W9F12.5DU | 766 | 1295 | 2061 | 143.5 |
| 6W3H6DU | 671 | 699 | 1369 | 143.5 |
| 6W3H7.5DU | 721 | 699 | 1420 | 143.5 |
| 6W4H7.5DU | 721 | 802 | 1523 | 143.5 |
| 6W2H5DU | 535 | 494 | 1029 | 143.5 |
| 6W5H12.5DU | 766 | 803 | 1569 | 143.5 |
| 6W6H12.5DU | 766 | 906 | 1672 | 143.5 |
| 6W24W12.5DU | 766 | 1572 | 2338 | 143.5 |

6W Magna Series Borewell Submersible Pumps



High Grade Electrical Stampings

Reduced Electrical losses lowers the operating current of the pump



Wide Voltage application

Designed to withstand wide voltage fluctuations from 250V-440V & Provides Consistent Performance



Lower Operating Current

Robust Electrical Design Ensures Lower Electrical Current and Lower Power Bill



High Thrust Capacity

Specially designed thrust bearing ensures highest reliability



Easy For Maintenance

Easily replaceable wear & tear Parts, Low maintenance cost

Technical Specifications:

- Range: 3 Phase – 3 HP to 12.5 HP (2.2 kW to 9.3 kW)
- Rated Voltage: 415V
- Voltage Range: 250-440V
- Rated Frequency: 50Hz
- Pipe Size: 50mm to 75mm
- Max. head: Up to 320 Meters.
- Max. Discharge : Up to 1400 LPM.
- Liquid: Clear Water
- Rotation: Anticlockwise

Application:

- Sprinkler irrigation
- Drip irrigation
- Agricultural farms
- Multistoried Buildings
- Construction sites
- Water supply for Industrial / Commercial Establishment
- Lawn Sprinklers



Performance Curve:

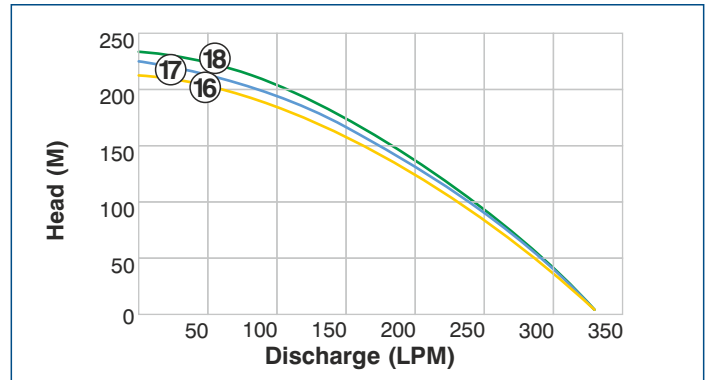
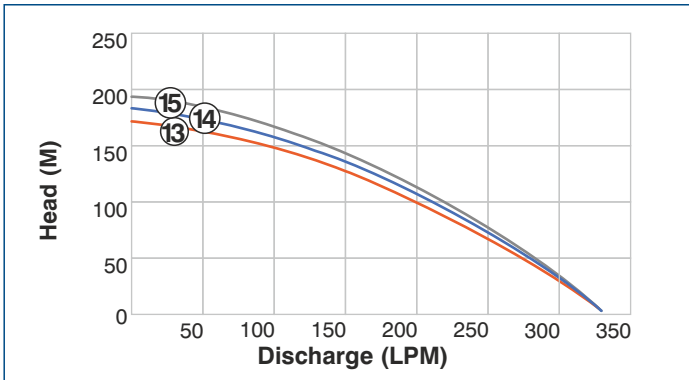
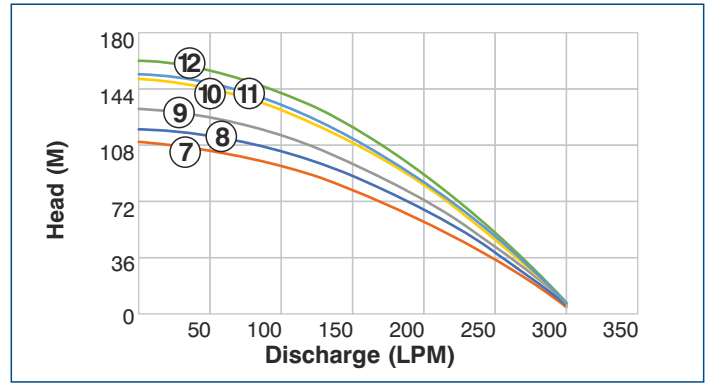
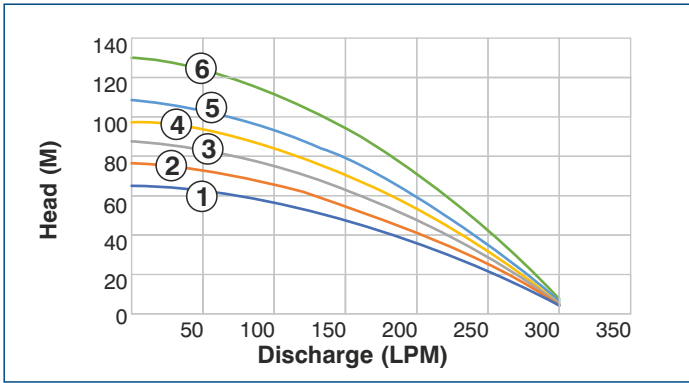

Performance Table:

| Sr. No. | Rating | No. Of Stages | Motor | | Pipe Size | Discharge in LPM | | | | | | |
|---------|----------|---------------|-------|-----|-----------|------------------|-----|-----|-----|-----|-----|-----|
| | | | kW | HP | | 0 | 70 | 130 | 150 | 200 | 250 | 300 |
| | | | | | | Head in Meter | | | | | | |
| 1 | 6WM6W3D | 6 | 2.2 | 3.0 | 50 | 65 | 59 | 52 | 48 | 35 | 20 | 4 |
| 2 | 6WM7W3D | 7 | 2.2 | 3.0 | 50 | 76 | 69 | 60 | 56 | 40 | 24 | 5 |
| 3 | 6WM8W3D | 8 | 2.2 | 3.0 | 50 | 87 | 79 | 69 | 64 | 46 | 27 | 5 |
| 4 | 6WM9W3D | 9 | 2.2 | 3.0 | 50 | 98 | 89 | 78 | 72 | 52 | 31 | 6 |
| 5 | 6WM10W4D | 10 | 3.0 | 4.0 | 50 | 109 | 99 | 86 | 80 | 58 | 34 | 7 |
| 6 | 6WM12W4D | 12 | 3.0 | 4.0 | 50 | 131 | 118 | 103 | 97 | 69 | 41 | 8 |

| Sr. No. | Rating | No. Of Stages | Motor | | Pipe Size | Discharge in LPM | | | | | | |
|---------|----------|---------------|-------|-----|-----------|------------------|-----|-----|-----|-----|-----|-----|
| | | | kW | HP | | 0 | 70 | 130 | 150 | 200 | 250 | 300 |
| | | | | | | Head in Meter | | | | | | |
| 7 | 6WM10W5D | 10 | 3.7 | 5.0 | 50 | 110 | 100 | 87 | 81 | 61 | 33 | 6 |
| 8 | 6WM11W5D | 11 | 3.7 | 5.0 | 50 | 118 | 110 | 96 | 89 | 67 | 37 | 6 |
| 9 | 6WM12W5D | 12 | 3.7 | 5.0 | 50 | 132 | 120 | 105 | 97 | 73 | 42 | 7 |
| 10 | 6WM14W5D | 14 | 3.7 | 5.0 | 50 | 151 | 138 | 120 | 110 | 84 | 45 | 7 |
| 11 | 6WM14W6D | 14 | 4.5 | 6.0 | 50 | 153 | 140 | 122 | 113 | 86 | 47 | 8 |
| 12 | 6WM15W6D | 15 | 4.5 | 6.0 | 50 | 163 | 149 | 130 | 120 | 91 | 49 | 8 |

| Sr. No. | Rating | No. Of Stages | Motor | | Pipe Size | Discharge in LPM | | | | | | |
|---------|------------|---------------|-------|-----|-----------|------------------|-----|-----|-----|-----|-----|-----|
| | | | kW | HP | | 0 | 70 | 130 | 150 | 200 | 250 | 330 |
| | | | | | | Head in Meter | | | | | | |
| 13 | 6WM16W6D | 16 | 4.5 | 6.0 | 50 | 170 | 159 | 139 | 131 | 102 | 56 | 8 |
| 14 | 6WM17W6D | 17 | 4.5 | 6.0 | 50 | 180 | 169 | 148 | 139 | 108 | 60 | 8 |
| 15 | 6WM18W7.5D | 18 | 5.5 | 7.5 | 50 | 191 | 179 | 157 | 147 | 115 | 63 | 9 |
| 16 | 6WM20W7.5D | 20 | 5.5 | 7.5 | 50 | 212 | 199 | 174 | 164 | 127 | 70 | 10 |
| 17 | 6WM21W7.5D | 21 | 5.5 | 7.5 | 50 | 223 | 209 | 183 | 172 | 134 | 74 | 10 |
| 18 | 6WM22W7.5D | 22 | 5.5 | 7.5 | 50 | 233 | 219 | 191 | 180 | 140 | 77 | 11 |

Performance Curve:

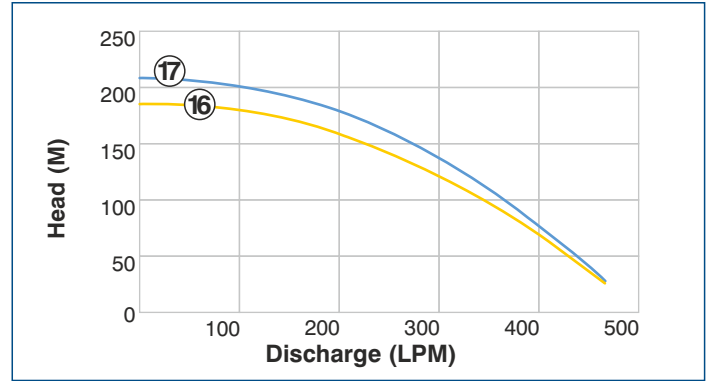
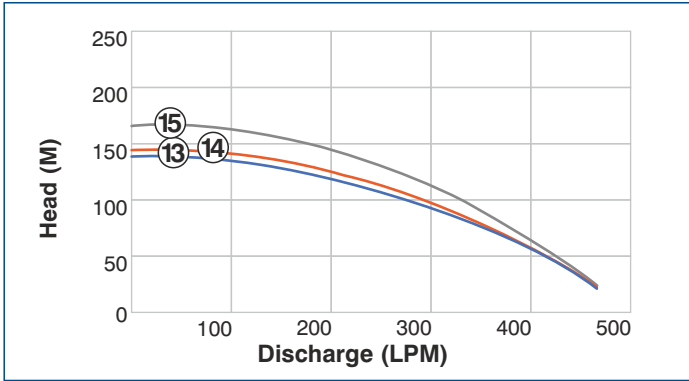
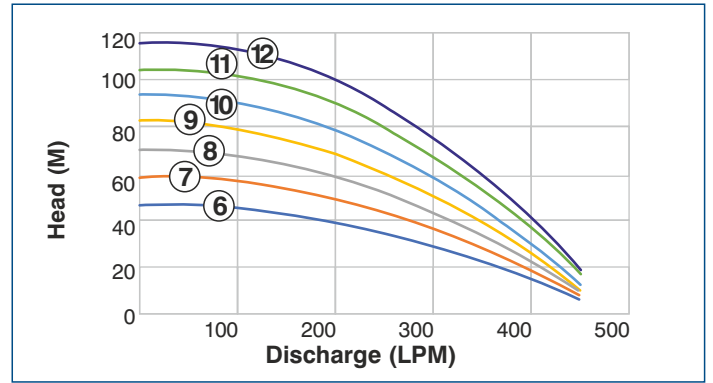
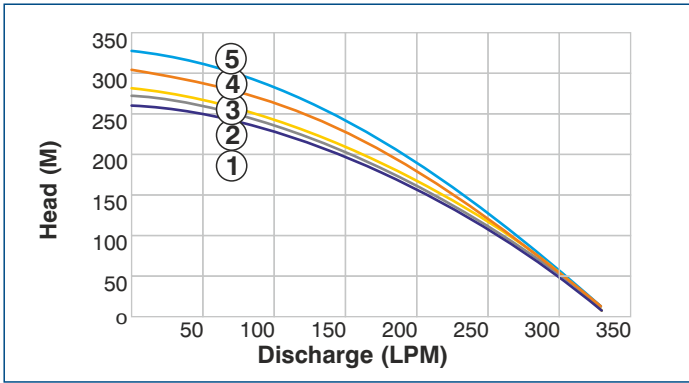

Performance Table:

| Sr. No. | Rating | No. Of Stages | Motor | | Pipe Size | Discharge in LPM | | | | | | |
|---------|-------------|---------------|-------|------|-----------|------------------|-----|-----|-----|-----|-----|-----|
| | | | kW | HP | | 0 | 70 | 130 | 150 | 200 | 250 | 330 |
| | | | | | | Head in Meter | | | | | | |
| 1 | 6WM24W10D | 24 | 7.5 | 10.0 | 50 | 257 | 241 | 211 | 198 | 154 | 85 | 12 |
| 2 | 6WM25W10D | 25 | 7.5 | 10.0 | 50 | 268 | 251 | 220 | 206 | 161 | 89 | 12 |
| 3 | 6WM26W12.5D | 26 | 9.3 | 12.5 | 50 | 278 | 261 | 228 | 215 | 167 | 92 | 13 |
| 4 | 6WM28W12.5D | 28 | 9.3 | 12.5 | 50 | 300 | 281 | 246 | 231 | 180 | 99 | 14 |
| 5 | 6WM30W12.5D | 30 | 9.3 | 12.5 | 50 | 321 | 302 | 263 | 248 | 193 | 106 | 15 |

| Sr. No. | Rating | No. Of Stages | Motor | | Pipe Size | Discharge in LPM | | | | | | |
|---------|----------|---------------|-------|-----|-----------|------------------|-----|------|------|-----|-----|-----|
| | | | kW | HP | | 0 | 100 | 160 | 250 | 300 | 400 | 450 |
| | | | | | | Head in Meter | | | | | | |
| 6 | 6WM4S3D | 4 | 2.2 | 3.0 | 50 | 48 | 44 | 41 | 35 | 30 | 16 | 5 |
| 7 | 6WM5S3D | 5 | 2.2 | 3.0 | 50 | 60 | 55 | 51 | 44 | 38 | 20 | 6 |
| 8 | 6WM6S4D | 6 | 3.0 | 4.0 | 50 | 72 | 66 | 61.5 | 52.5 | 45 | 24 | 8 |
| 9 | 6WM7S5D | 7 | 3.7 | 5.0 | 50 | 84 | 77 | 72 | 61 | 53 | 28 | 9 |
| 10 | 6WM8S5D | 8 | 3.7 | 5.0 | 50 | 96 | 88 | 82 | 70 | 60 | 32 | 10 |
| 11 | 6WM9S6D | 9 | 4.5 | 6.0 | 50 | 107 | 97 | 93 | 81 | 72 | 38 | 14 |
| 12 | 6WM10S6D | 10 | 4.5 | 6.0 | 50 | 119 | 108 | 103 | 90 | 80 | 42 | 16 |

| Sr. No. | Rating | No. Of Stages | Motor | | Pipe Size | Discharge in LPM | | | | | | |
|---------|-------------|---------------|-------|------|-----------|------------------|-----|-----|-----|-----|-----|-----|
| | | | kW | HP | | 0 | 100 | 160 | 250 | 300 | 400 | 450 |
| | | | | | | Head in Meter | | | | | | |
| 13 | 6WM12S7.5D | 12 | 5.5 | 7.5 | 50 | 141 | 130 | 124 | 110 | 96 | 55 | 30 |
| 14 | 6WM13S10D | 13 | 7.5 | 10 | 50 | 146 | 139 | 131 | 114 | 101 | 60 | 29 |
| 15 | 6WM15S10D | 15 | 7.5 | 10 | 50 | 169 | 160 | 151 | 131 | 117 | 69 | 33 |
| 16 | 6WM16S12.5D | 16 | 9.3 | 12.5 | 50 | 188 | 176 | 167 | 142 | 124 | 71 | 34 |
| 17 | 6WM18S12.5D | 18 | 9.3 | 12.5 | 50 | 211 | 198 | 188 | 160 | 140 | 80 | 38 |

Performance Curve:

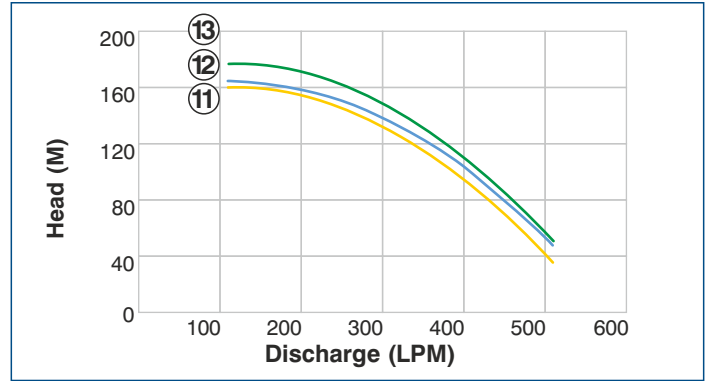
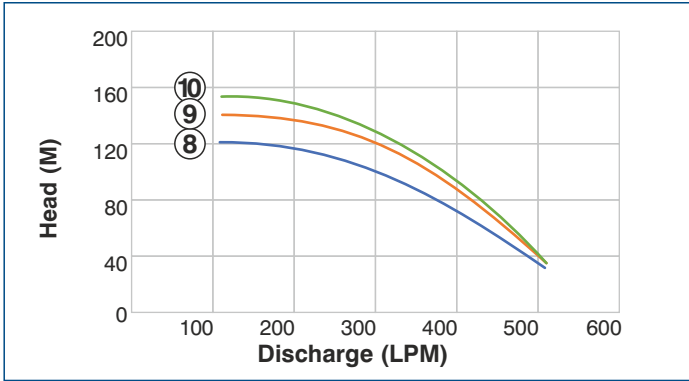
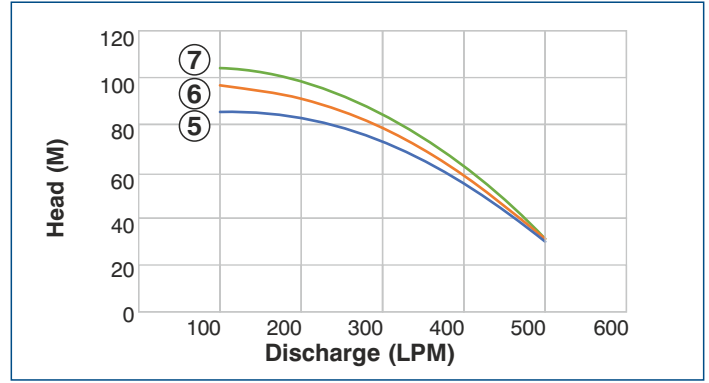
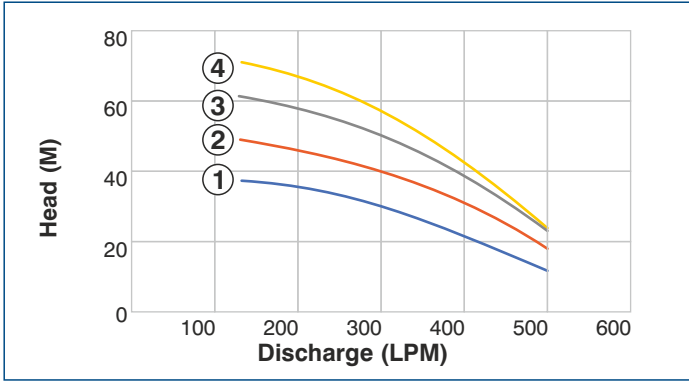

Performance Table:

| Sr. No. | Rating | No. Of Stages | Motor | | Pipe Size | Discharge in LPM | | | | | | |
|---------|---------|---------------|-------|-----|-----------|------------------|-----|-----|-----|-----|-----|-----|
| | | | kW | HP | | 130 | 180 | 240 | 310 | 350 | 400 | 500 |
| | | | | | | Head in Meter | | | | | | |
| 1 | 6WM3R3D | 3 | 2.2 | 3.0 | 50 | 37 | 36 | 34 | 30 | 26 | 22 | 12 |
| 2 | 6WM4R4D | 4 | 3.0 | 4.0 | 50 | 49 | 48 | 44 | 40 | 36 | 31 | 18 |
| 3 | 6WM5R5D | 5 | 3.7 | 5.0 | 50 | 61 | 59 | 55 | 49 | 45 | 39 | 23 |
| 4 | 6WM6R5D | 6 | 3.7 | 5.0 | 50 | 72 | 68 | 63 | 57 | 51 | 42 | 24 |

| Sr. No. | Rating | No. Of Stages | Motor | | Pipe Size | Discharge in LPM | | | | | | |
|---------|-----------|---------------|-------|-----|-----------|------------------|-----|-----|-----|-----|-----|-----|
| | | | kW | HP | | 100 | 200 | 250 | 300 | 350 | 400 | 500 |
| | | | | | | Head in Meter | | | | | | |
| 5 | 6WM7R6D | 7 | 4.5 | 6.0 | 50 | 86 | 83 | 78 | 72 | 65 | 56 | 30 |
| 6 | 6WM8R7.5D | 8 | 5.5 | 7.5 | 50 | 96 | 92 | 86 | 77 | 69 | 58 | 31 |
| 7 | 6WM9R7.5D | 9 | 5.5 | 7.5 | 50 | 103 | 100 | 95 | 85 | 73 | 60 | 32 |

| Sr. No. | Rating | No. Of Stages | Motor | | Pipe Size | Discharge in LPM | | | | | | | |
|---------|-------------|---------------|-------|------|-----------|------------------|-----|-----|-----|-----|-----|-----|-----|
| | | | kW | HP | | 110 | 200 | 200 | 250 | 300 | 350 | 400 | 510 |
| | | | | | | Head in Meter | | | | | | | |
| 8 | 6WM10R10D | 10 | 7.5 | 10.0 | 50 | 121 | 116 | 116 | 111 | 101 | 86 | 71 | 31 |
| 9 | 6WM11R10D | 11 | 7.5 | 10.0 | 50 | 141 | 134 | 134 | 131 | 121 | 107 | 86 | 34 |
| 10 | 6WM12R10D | 12 | 7.5 | 10.0 | 50 | 154 | 146 | 146 | 142 | 132 | 115 | 90 | 35 |
| 11 | 6WM12R12.5D | 12 | 9.3 | 12.5 | 50 | 161 | 151 | 151 | 146 | 136 | 116 | 91 | 36 |
| 12 | 6WM13R12.5D | 13 | 9.3 | 12.5 | 50 | 165 | 156 | 156 | 150 | 140 | 122 | 102 | 47 |
| 13 | 6WM14R12.5D | 14 | 9.3 | 12.5 | 50 | 176 | 169 | 169 | 161 | 151 | 131 | 109 | 51 |

Performance Curve:

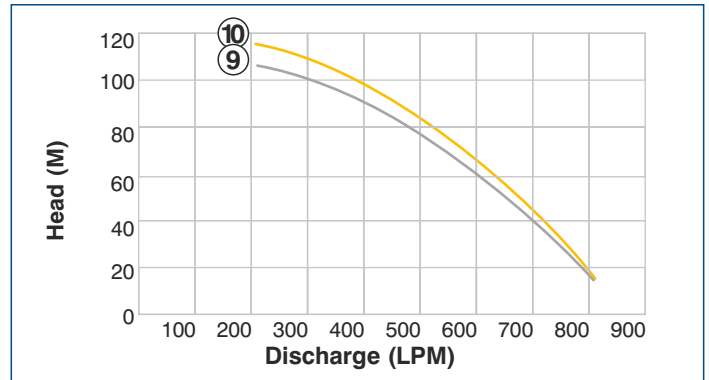
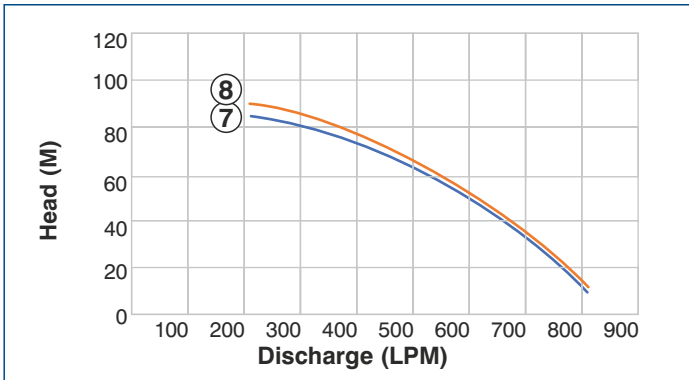
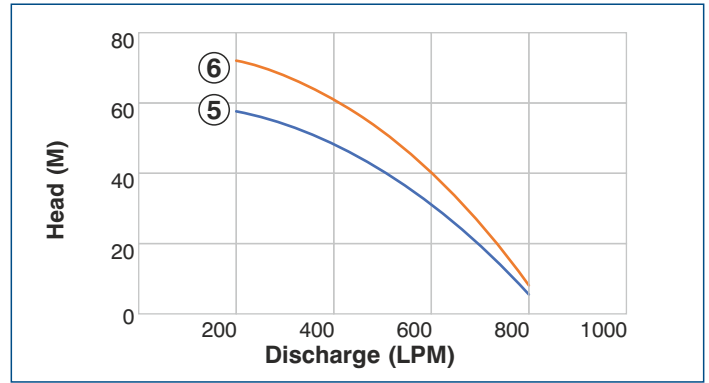
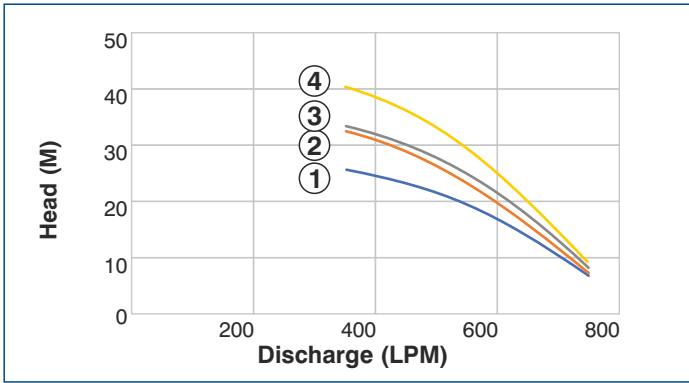

Performance Table:

| Sr. No. | Rating | No. Of Stages | Motor | | Pipe Size | Discharge in LPM | | | | | | |
|---------|---------|---------------|-------|-----|-----------|------------------|-----|-----|-----|-----|-----|-----|
| | | | kW | HP | | 350 | 450 | 500 | 600 | 650 | 700 | 750 |
| | | | | | | Head in Meter | | | | | | |
| 1 | 6WM3D3D | 3 | 2.2 | 3.0 | 65 | 32 | 23 | 21 | 17 | 15 | 11 | 6 |
| 2 | 6WM4D3D | 4 | 2.2 | 3.0 | 65 | 33 | 28 | 27 | 20 | 16 | 12 | 7 |
| 3 | 6WM4D4D | 4 | 3.0 | 4.0 | 65 | 34 | 30 | 28 | 22 | 18 | 13 | 8 |
| 4 | 6WM5D5D | 5 | 3.7 | 5.0 | 65 | 41 | 36 | 33 | 26 | 21 | 15 | 9 |

| Sr. No. | Rating | No. Of Stages | Motor | | Pipe Size | Discharge in LPM | | | | | | |
|---------|-----------|---------------|-------|-----|-----------|------------------|-----|-----|-----|-----|-----|-----|
| | | | kW | HP | | 200 | 300 | 400 | 500 | 600 | 700 | 800 |
| | | | | | | Head in Meter | | | | | | |
| 5 | 6WM6D6D | 6 | 4.5 | 6.0 | 65 | 58 | 54 | 48 | 41 | 31 | 20 | 5 |
| 6 | 6WM8D7.5D | 8 | 5.5 | 7.5 | 65 | 73 | 67 | 61 | 52 | 41 | 24 | 8 |

| Sr. No. | Rating | No. Of Stages | Motor | | Pipe Size | Discharge in LPM | | | | | | |
|---------|-------------|---------------|-------|------|-----------|------------------|-----|-----|-----|-----|-----|-----|
| | | | kW | HP | | 210 | 300 | 400 | 500 | 600 | 700 | 810 |
| | | | | | | Head in Meter | | | | | | |
| 7 | 6WM9D10D | 9 | 7.5 | 10.0 | 65 | 86 | 80 | 73 | 63 | 51 | 34 | 8 |
| 8 | 6WM10D10D | 10 | 7.5 | 10.0 | 65 | 92 | 84 | 76 | 66 | 53 | 36 | 11 |
| 9 | 6WM11D12.5D | 11 | 9.3 | 12.5 | 65 | 107 | 100 | 90 | 78 | 61 | 39 | 15 |
| 10 | 6WM12D12.5D | 12 | 9.3 | 12.5 | 65 | 117 | 109 | 98 | 85 | 67 | 43 | 16 |

Performance Curve:

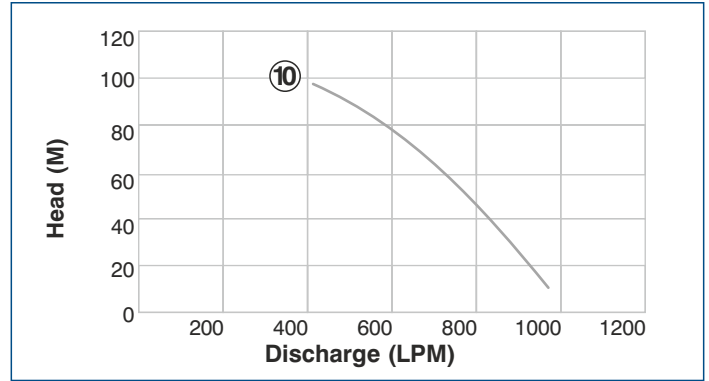
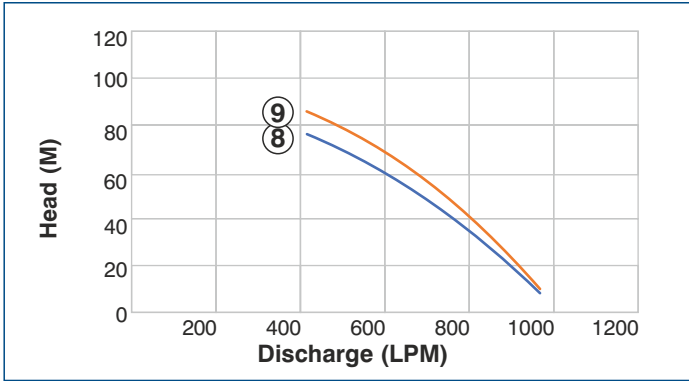
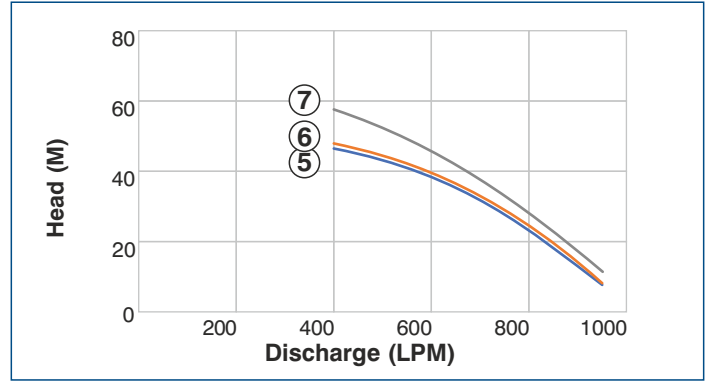
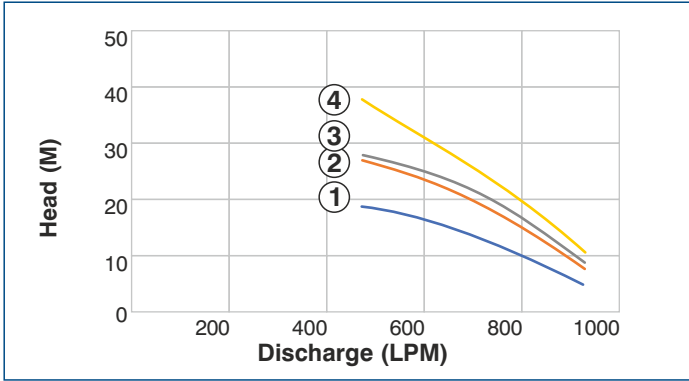

Performance Table:

| Sr. No. | Rating | No. Of Stages | Motor | | Pipe Size | Discharge in LPM | | | | | |
|---------|---------|---------------|-------|-----|-----------|------------------|-----|-----|-----|-----|-----|
| | | | kW | HP | | 440 | 650 | 700 | 780 | 840 | 930 |
| | | | | | | Head in Meter | | | | | |
| 1 | 6WM2F3D | 2 | 2.2 | 3.0 | 75 | 19 | 16 | 14 | 11 | 9 | 6 |
| 2 | 6WM3F4D | 3 | 3.0 | 4.0 | 75 | 27 | 22 | 20 | 16 | 13 | 8 |
| 3 | 6WM3F5D | 3 | 3.7 | 5.0 | 75 | 28 | 24 | 22 | 17 | 14 | 9 |
| 4 | 6WM4F5D | 4 | 3.7 | 5.0 | 75 | 38 | 28 | 25 | 20 | 15 | 11 |

| Sr. No. | Rating | No. Of Stages | Motor | | Pipe Size | Discharge in LPM | | | | | | |
|---------|-----------|---------------|-------|-----|-----------|------------------|-----|-----|-----|-----|-----|-----|
| | | | kW | HP | | 400 | 500 | 600 | 700 | 800 | 900 | 950 |
| | | | | | | Head in Meter | | | | | | |
| 5 | 6WM5F6D | 5 | 4.5 | 6.0 | 75 | 46 | 43 | 39 | 31 | 23 | 13 | 7 |
| 6 | 6WM5F7.5D | 5 | 5.5 | 7.5 | 75 | 48 | 44 | 40 | 32 | 24 | 14 | 8 |
| 7 | 6WM6F7.5D | 6 | 5.5 | 7.5 | 75 | 57 | 53 | 46 | 37 | 28 | 16 | 12 |

| Sr. No. | Rating | No. Of Stages | Motor | | Pipe Size | Discharge in LPM | | | | | | |
|---------|-------------|---------------|-------|------|-----------|------------------|-----|-----|-----|-----|-----|-----|
| | | | kW | HP | | 410 | 500 | 600 | 700 | 800 | 900 | 970 |
| | | | | | | Head in Meter | | | | | | |
| 8 | 6WM8F10D | 8 | 7.5 | 10.0 | 75 | 76 | 70 | 62 | 49 | 35 | 20 | 9 |
| 9 | 6WM9F12.5D | 9 | 9.3 | 12.5 | 75 | 86 | 79 | 70 | 56 | 41 | 22 | 11 |
| 10 | 6WM10F12.5D | 10 | 9.3 | 12.5 | 75 | 97 | 89 | 79 | 64 | 46 | 24 | 13 |

Performance Curve:

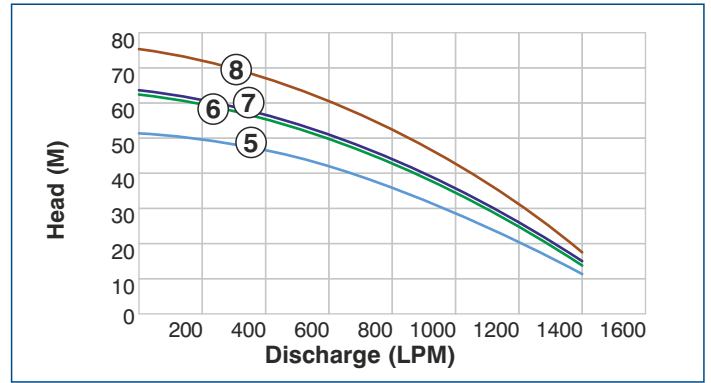
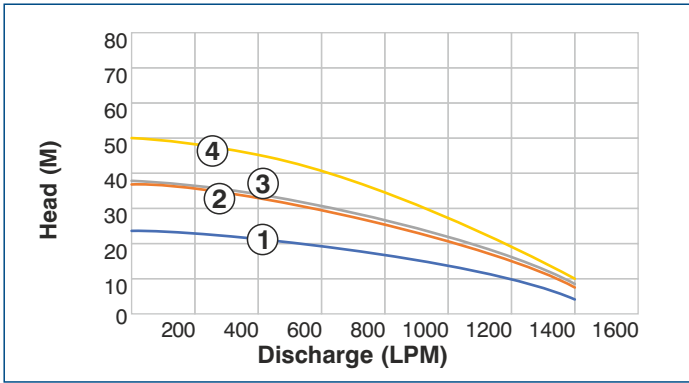

Performance Table:

| Sr. No. | Rating | No. Of Stages | Motor | | Pipe Size | Discharge in LPM | | | | | | |
|---------|------------|---------------|-------|------|-----------|------------------|-----|-----|-----|------|------|------|
| | | | kW | HP | | 0 | 600 | 700 | 900 | 1100 | 1250 | 1400 |
| | | | | | | Head in Meter | | | | | | |
| 1 | 6WM2Q5D | 2 | 3.7 | 5 | 75 | 24 | 19 | 18 | 16 | 12 | 7 | 5 |
| 2 | 6WM3Q6D | 3 | 4.6 | 6 | 75 | 37 | 29 | 27 | 24 | 19 | 13 | 7 |
| 3 | 6WM3Q7.5D | 3 | 5.5 | 7.5 | 75 | 38 | 30 | 28 | 25 | 20 | 14 | 8 |
| 4 | 6WM4Q7.5D | 4 | 5.5 | 7.5 | 75 | 51 | 39 | 37 | 34 | 25 | 17 | 9 |
| 5 | 6WM4Q10D | 4 | 7.5 | 10 | 75 | 52 | 40 | 38 | 35 | 26 | 18 | 10 |
| 6 | 6WM5Q10D | 5 | 7.5 | 10 | 75 | 63 | 48 | 46 | 41 | 31 | 23 | 12 |
| 7 | 6WM5Q12.5D | 5 | 9.3 | 12.5 | 75 | 64 | 49 | 47 | 42 | 32 | 24 | 13 |
| 8 | 6WM6Q12.5D | 6 | 9.3 | 12.5 | 75 | 76 | 58 | 55 | 50 | 40 | 29 | 15 |

Note :

1. The motor ratings in HP are only indicative and for reference purpose
2. Performance figures given above are approximate and may differ on site conditions

3. Performance mentioned on nameplate may vary as we are always improving our products

Material of Construction:

| Sr. No. | Part | Material |
|---------|-----------------------------------|--------------------------|
| 1 | Bowl | Cast Iron- Grade FG 200 |
| 2 | Impeller | Stainless steel (SS410) |
| 3 | Pump/Motor Shaft | Stainless Steel- SS410 |
| 4 | NRV | Cast Iron - Grade FG 200 |
| 5 | Suction Housing | Cast Iron - Grade FG 200 |
| 6 | Motor Body | Stainless Steel- SS202 |
| 7 | Upper & Lower Housing, Motor Base | Cast Iron - Grade FG 200 |
| 8 | Stamping | CRNGO |
| 9 | Bearing Bush | Bronze LTB-4 |
| 10 | Thrust Bearing | Carbon Vs SS |
| 11 | Fasteners | Stainless Steel- SS410 |
| 12 | Strainer | Stainless Steel - SS202 |
| 13 | Sealing | Oil Seal |

Pump Dimensional Details:

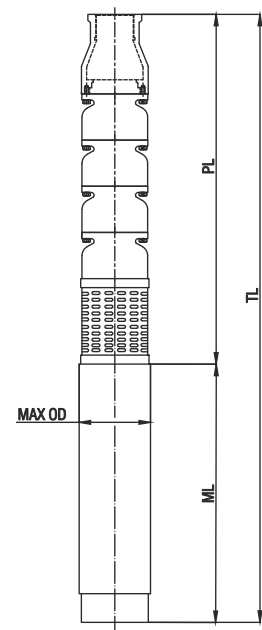

| All Dimensions are in mm | | | | |
|--------------------------|-----------|------|-------|-------|
| Rating | ML | PL | TL | D |
| | Length mm | | | |
| | Motor | Pump | Total | |
| 6WM3D3D | 509 | 548 | 1057 | 143.5 |
| 6WM4D3D | 509 | 638 | 1147 | 143.5 |
| 6WM4D4D | 509 | 638 | 1147 | 143.5 |
| 6WM5D5D | 535 | 728 | 1263 | 143.5 |
| 6WM2F3D | 509 | 495 | 1004 | 143.5 |
| 6WM3F4D | 509 | 595 | 1104 | 143.5 |
| 6WM3F5D | 535 | 595 | 1130 | 143.5 |
| 6WM4F5D | 535 | 695 | 1230 | 143.5 |
| 6WM3R3D | 509 | 427 | 936 | 143.5 |
| 6WM4R4D | 509 | 467 | 976 | 143.5 |
| 6WM5R5D | 535 | 507 | 1042 | 143.5 |
| 6WM6R5D | 535 | 547 | 1082 | 143.5 |
| 6WM5F6D | 671 | 897 | 1567 | 143.5 |
| 6WM5F7.5D | 721 | 897 | 1618 | 143.5 |
| 6WM6F7.5D | 721 | 997 | 1718 | 143.5 |
| 6WM6D6D | 671 | 919 | 1590 | 143.5 |
| 6WM8D7.5D | 721 | 1099 | 1820 | 143.5 |
| 6WM7R6D | 671 | 689 | 1360 | 143.5 |
| 6WM8R7.5D | 721 | 729 | 1450 | 143.5 |
| 6WM9R7.5D | 721 | 769 | 1490 | 143.5 |
| 6WM10D10D | 766 | 1268 | 2034 | 143.5 |
| 6WM9D10D | 766 | 1178 | 1944 | 143.5 |
| 6WM8F10D | 766 | 1195 | 1961 | 143.5 |
| 6WM12R10D | 766 | 787 | 1553 | 143.5 |
| 6WM11R10D | 766 | 747 | 1513 | 143.5 |
| 6WM10R10D | 766 | 707 | 1473 | 143.5 |
| 6WM12D12.5D | 766 | 1448 | 2214 | 143.5 |
| 6WM10F12.5D | 766 | 1395 | 2161 | 143.5 |
| 6WM14R12.5D | 766 | 867 | 1633 | 143.5 |
| 6WM13R12.5D | 766 | 827 | 1593 | 143.5 |
| 6WM12R12.5D | 766 | 787 | 1553 | 143.5 |
| 6WM11D12.5D | 766 | 1358 | 2124 | 143.5 |
| 6WM9F12.5D | 766 | 1295 | 2061 | 143.5 |
| 6WM6W3D | 509 | 655 | 1164 | 143.5 |
| 6WM7W3D | 509 | 699 | 1208 | 143.5 |
| 6WM8W3D | 509 | 743 | 1252 | 143.5 |
| 6WM9W3D | 509 | 787 | 1296 | 143.5 |
| 6WM10W4D | 509 | 831 | 1340 | 143.5 |

| All Dimensions are in mm | | | | |
|--------------------------|-----------|------|-------|-------|
| Rating | ML | PL | TL | D |
| | Length mm | | | |
| | Motor | Pump | Total | |
| 6WM12W4D | 509 | 919 | 1428 | 143.5 |
| 6WM10W5D | 535 | 831 | 1366 | 143.5 |
| 6WM11W5D | 535 | 875 | 1410 | 143.5 |
| 6WM12W5D | 535 | 919 | 1454 | 143.5 |
| 6WM14W5D | 535 | 1007 | 1542 | 143.5 |
| 6WM14W6D | 671 | 1007 | 1678 | 143.5 |
| 6WM15W6D | 671 | 1051 | 1722 | 143.5 |
| 6WM16W6D | 671 | 1095 | 1766 | 143.5 |
| 6WM17W6D | 671 | 1139 | 1810 | 143.5 |
| 6WM18W7.5D | 721 | 1183 | 1904 | 143.5 |
| 6WM20W7.5D | 721 | 1271 | 1992 | 143.5 |
| 6WM21W7.5D | 721 | 1315 | 2036 | 143.5 |
| 6WM22W7.5D | 721 | 1359 | 2080 | 143.5 |
| 6WM24W10D | 766 | 1447 | 2213 | 143.5 |
| 6WM25W10D | 766 | 1491 | 2257 | 143.5 |
| 6WM26W12.5D | 766 | 1535 | 2301 | 143.5 |
| 6WM28W12.5D | 766 | 1623 | 2389 | 143.5 |
| 6WM30W12.5D | 766 | 1711 | 2477 | 143.5 |
| 6WM4S3D | 509 | 578 | 1087 | 143.5 |
| 6WM5S3D | 509 | 625 | 1134 | 143.5 |
| 6WM6S4D | 509 | 672 | 1181 | 143.5 |
| 6WM7S5D | 535 | 719 | 1254 | 143.5 |
| 6WM8S5D | 535 | 766 | 1301 | 143.5 |
| 6WM9S6D | 671 | 813 | 1484 | 143.5 |
| 6WM10S6D | 671 | 860 | 1531 | 143.5 |
| 6WM12S7.5D | 721 | 954 | 1675 | 143.5 |
| 6WM13S10D | 766 | 1001 | 1767 | 143.5 |
| 6WM15S10D | 766 | 1095 | 1861 | 143.5 |
| 6WM16S12.5D | 766 | 1142 | 1908 | 143.5 |
| 6WM18S12.5D | 766 | 1236 | 2002 | 143.5 |
| 6WM2Q5D | 535 | 535 | 1070 | 143.5 |
| 6WM3Q6D | 671 | 633 | 1304 | 143.5 |
| 6WM3Q7.5D | 721 | 633 | 1354 | 143.5 |
| 6WM4Q7.5D | 721 | 730 | 1451 | 143.5 |
| 6WM4Q10D | 766 | 730 | 1496 | 143.5 |
| 6WM5Q10D | 766 | 828 | 1594 | 143.5 |
| 6WM5Q12.5D | 766 | 828 | 1594 | 143.5 |
| 6WM6Q12.5D | 766 | 925 | 1691 | 143.5 |

6W/150W Series Borewell Submersible Pumps



High Grade Electrical Stampings

Reduced Electrical losses lowers the operating current of the pump



Wide Voltage application

Designed to withstand wide voltage fluctuations from 350V-440V & Provides Consistent Performance



Lower Operating Current

Robust Electrical Design Ensures Lower Electrical Current and Lower Power Bill



High Thrust Capacity

Specially designed thrust bearing ensures highest reliability



Easy For Maintenance

Easily replaceable wear & tear Parts, Low maintenance cost

Technical Specifications:

- Range: 15HP to 30HP (11kW to 22kW)
- Rated voltage: 415V for 3PH
- Voltage range: 350V - 440V for 3PH
- Rated Frequency: 50Hz
- Delivery pipe size: 50mm to 100mm
- Max. Head: Upto 362 meter
- Max. Discharge: Upto 1200LPM
- Liquid: Clear water
- Motor type: Water filled motor

Application:

- Sprinkler irrigation
- Drip irrigation
- Agricultural farms
- Multistoried Buildings
- Construction sites
- Water supply for Industrial / Commercial Establishment
- Lawn Sprinklers



Performance Curve:

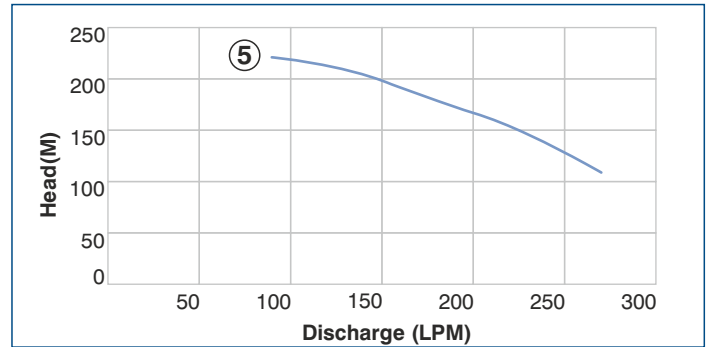
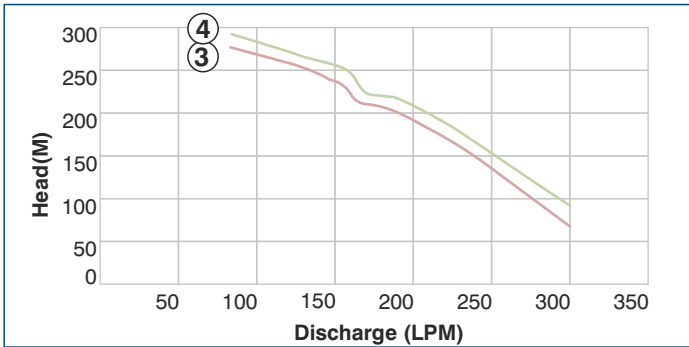
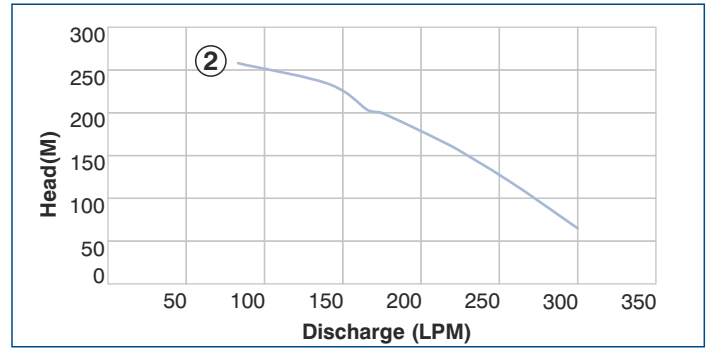
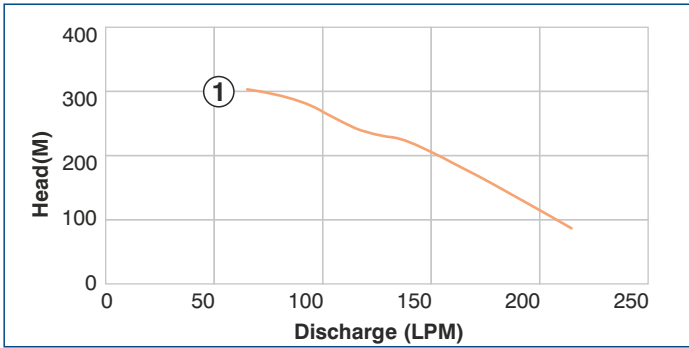

Performance Table:

| Sr. No. | Rating ISI | Rating ISI | No. Of Stages | Outlet Size mm | Motor | | Discharge in LPM | | | | | | |
|------------------------------------|------------|------------|---------------|----------------|-------|----|------------------|-----|-----|-----|-----|-----|-----|
| | 6W-V | 150W-V | | | kW | HP | 65 | 90 | 117 | 140 | 165 | 190 | 215 |
| 150mm Radial Flow Submersible Pump | | | | | | | Head in Meter | | | | | | |
| 1 | 6W30V15 | 150W30V15 | 30 | 50 | 11 | 15 | 303 | 270 | 240 | 221 | 180 | 134 | 87 |

| Sr. No. | Rating ISI | Rating ISI | No. Of Stages | Outlet Size mm | Motor | | Discharge in LPM | | | | | | |
|------------------------------------|------------|------------|---------------|----------------|-------|----|------------------|-----|-----|-----|-----|-----|-----|
| | 6W-W | 150W-W | | | kW | HP | 80 | 130 | 155 | 165 | 190 | 235 | 300 |
| 150mm Radial Flow Submersible Pump | | | | | | | Head in Meter | | | | | | |
| 2 | 6W26W15 | 150W26W15 | 26 | 50 | 11 | 15 | 258 | 232 | 212 | 192 | 184 | 144 | 65 |

| Sr. No. | Rating ISI | Rating ISI | No. Of Stages | Outlet Size mm | Motor | | Discharge in LPM | | | | | | |
|------------------------------------|------------|-------------|---------------|----------------|-------|------|------------------|-----|-----|-----|-----|-----|-----|
| | 6W-W | 150W-W | | | kW | HP | 80 | 130 | 155 | 165 | 190 | 235 | 300 |
| 150mm Radial Flow Submersible Pump | | | | | | | Head in Meter | | | | | | |
| 3 | 6W28W15 | 150W28W15 | 28 | 50 | 11 | 15 | 280 | 255 | 231 | 210 | 200 | 157 | 66 |
| 4 | 6W30W17.5 | 150W30W17.5 | 30 | 50 | 13 | 17.5 | 297 | 267 | 245 | 222 | 213 | 166 | 81 |

| Sr. No. | Rating ISI | Rating ISI | No. Of Stages | Outlet Size mm | Motor | | Discharge in LPM | | | | | | |
|------------------------------------|------------|------------|---------------|----------------|-------|----|------------------|-----|-----|-----|-----|-----|-----|
| | 6W-X | 150W-X | | | kW | HP | 90 | 120 | 150 | 180 | 210 | 240 | 270 |
| 150mm Radial Flow Submersible Pump | | | | | | | Head in Meter | | | | | | |
| 5 | 6W22X15 | 150W22X15 | 22 | 50 | 11 | 15 | 221 | 213 | 198 | 178 | 160 | 136 | 108 |

Performance Curve:

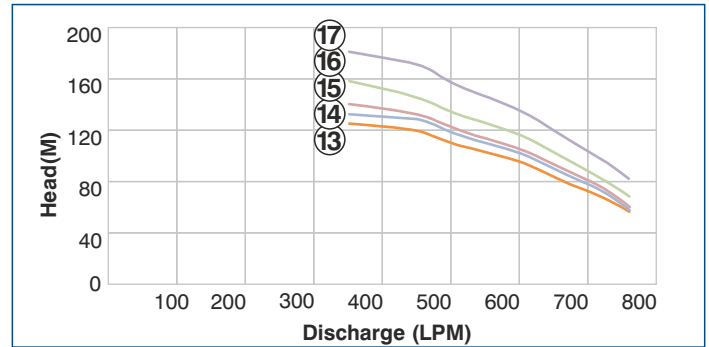
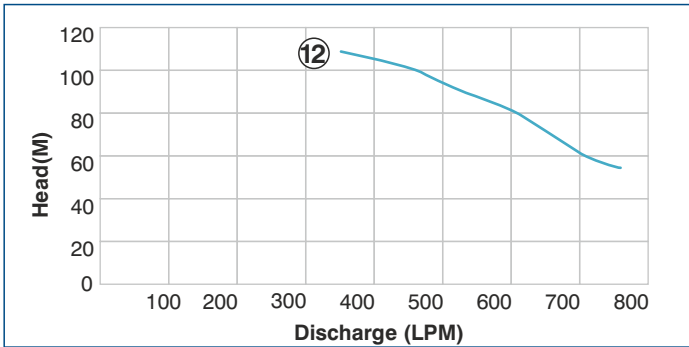
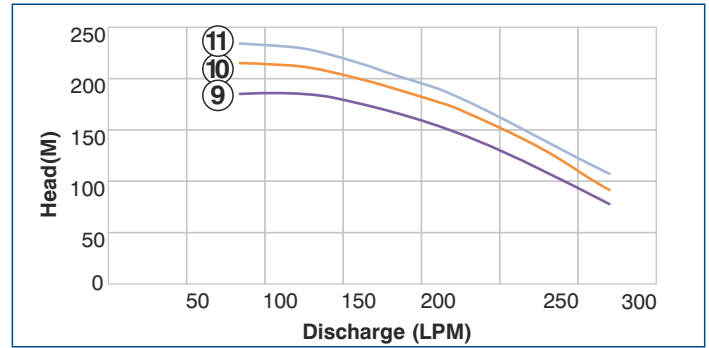
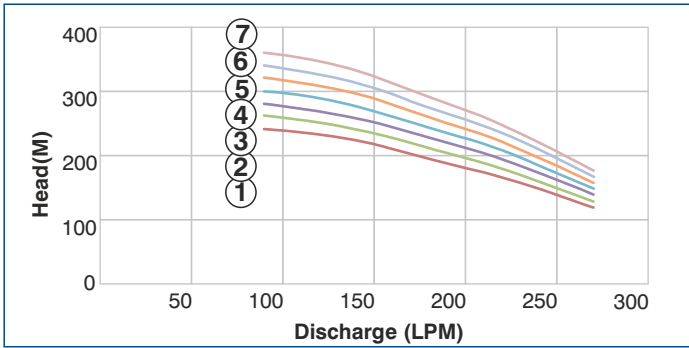

Performance Table:

| Sr. No. | Rating ISI | Rating ISI | No. Of Stages | Outlet Size mm | Motor | | Discharge in LPM | | | | | | |
|---|------------|-------------|---------------|----------------|-------|------|----------------------|-----|-----|-----|-----|-----|-----|
| | 6W-X | 150W-X | | | kW | HP | 90 | 120 | 150 | 180 | 210 | 240 | 270 |
| 150mm Radial Flow Submersible Pump | | | | | | | Head in Meter | | | | | | |
| 1 | 6W24X15 | 150W24X15 | 24 | 50 | 11 | 15 | 241 | 232 | 212 | 194 | 174 | 148 | 118 |
| 2 | 6W26X17.5 | 150W26X17.5 | 26 | 50 | 13 | 17.5 | 262 | 251 | 234 | 211 | 189 | 160 | 128 |
| 3 | 6W28X17.5 | 150W28X17.5 | 28 | 50 | 13 | 17.5 | 282 | 270 | 252 | 227 | 203 | 173 | 138 |
| 4 | 6W30X20 | 150W30X20 | 30 | 50 | 15 | 20 | 302 | 290 | 270 | 243 | 218 | 185 | 148 |
| 5 | 6W32X20 | 150W32X20 | 32 | 50 | 15 | 20 | 322 | 309 | 288 | 259 | 232 | 197 | 157 |
| 6 | 6W34X22.5 | 150W34X22.5 | 34 | 50 | 16.8 | 22.5 | 342 | 328 | 306 | 275 | 247 | 210 | 167 |
| 7 | 6W36X22.5 | 150W36X22.5 | 36 | 50 | 16.8 | 22.5 | 362 | 348 | 324 | 292 | 261 | 222 | 177 |

| Sr. No. | Rating ISI | Rating ISI | No. Of Stages | Outlet Size mm | Motor | | Discharge in LPM | | | | | | |
|---|------------|------------|---------------|----------------|-------|----|----------------------|-----|-----|-----|-----|-----|-----|
| | 6W-R | 150W-R | | | kW | HP | 120 | 180 | 240 | 310 | 210 | 240 | 270 |
| 150mm Radial Flow Submersible Pump | | | | | | | Head in Meter | | | | | | |
| 9 | 6W15R15 | 150W15R15 | 15 | 50 | 11.3 | 15 | 178 | 174 | 159 | 137 | 118 | 99 | 79 |
| 10 | 6W18R20 | 150W18R20 | 18 | 50 | 15 | 20 | 213 | 208 | 190 | 165 | 141 | 118 | 95 |
| 11 | 6W20R20 | 150W20R20 | 20 | 50 | 15 | 20 | 237 | 231 | 211 | 183 | 157 | 131 | 106 |

| Sr. No. | Rating ISI | Rating ISI | No. Of Stages | Outlet Size mm | Motor | | Discharge in LPM | | | | | | |
|--|------------|-------------|---------------|----------------|-------|------|----------------------|-----|-----|-----|-----|-----|-----|
| | 6W-D | 150W-D | | | kW | HP | 350 | 450 | 504 | 600 | 660 | 720 | 760 |
| 150mm Mixed Flow Submersible Pump | | | | | | | Head in Meter | | | | | | |
| 12 | 6W12D15 | 150W12D15 | 12 | 65 | 11 | 15 | 109 | 101 | 93 | 81 | 69 | 58 | 54 |
| 13 | 6W14D17.5 | 150W14D17.5 | 14 | 65 | 13 | 17.5 | 125 | 119 | 109 | 95 | 81 | 68 | 57 |
| 14 | 6W15D20 | 150W15D20 | 15 | 65 | 15 | 20 | 132 | 128 | 117 | 102 | 87 | 73 | 58 |
| 15 | 6W16D20 | 150W16D20 | 16 | 65 | 15 | 20 | 140 | 132 | 121 | 105 | 90 | 75 | 60 |
| 16 | 6W18D22.5 | 150W18D22.5 | 18 | 65 | 16.8 | 22.5 | 158 | 145 | 133 | 116 | 99 | 82 | 68 |
| 17 | 6W20D25 | 150W20D25 | 20 | 65 | 18.7 | 25 | 181 | 171 | 156 | 135 | 116 | 97 | 82 |

Performance Curve:

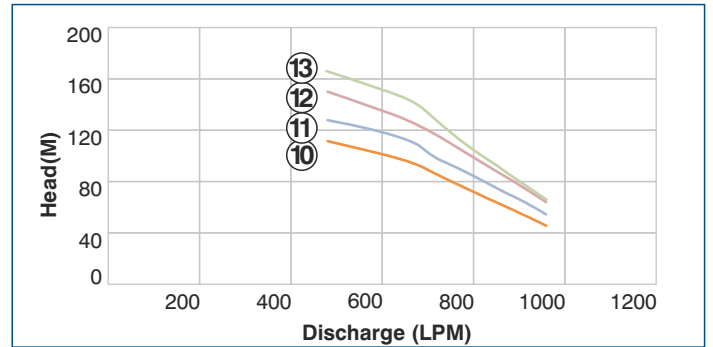
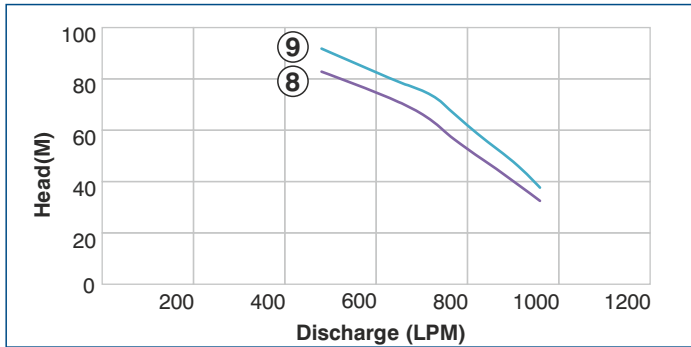
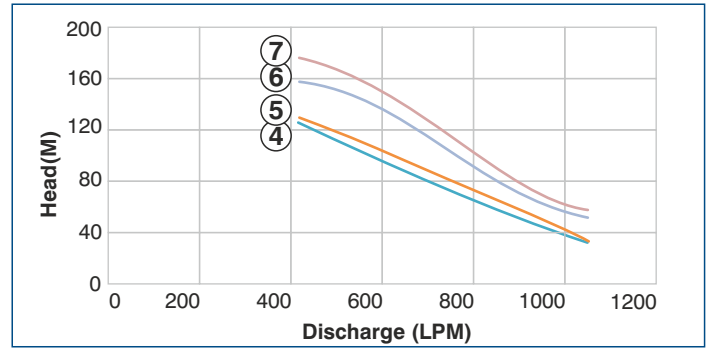
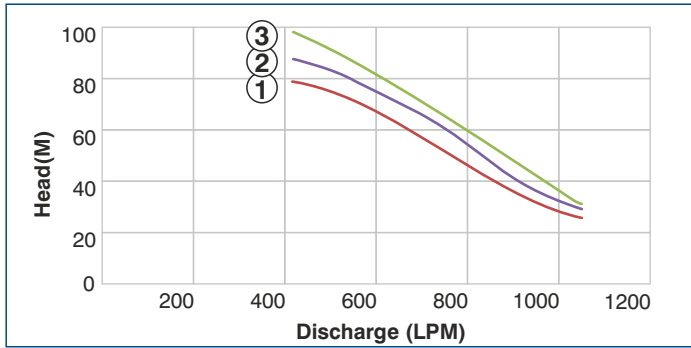

Performance Table:

| Sr. No. | Rating ISI | Rating ISI | No. Of Stages | Outlet Size mm | Motor | | Discharge in LPM | | | | | | | |
|--|------------|-------------------------------|---------------|----------------|-------|------|----------------------|-----|-----|-----|-----|-----|-----|------|
| | 6W-E | 150W-E | | | kW | HP | 420 | 495 | 690 | 750 | 810 | 870 | 930 | 1050 |
| 150mm Mixed Flow Submersible Pump | | | | | | | Head in Meter | | | | | | | |
| 1 | 6W9E15 | 150W9E15/150W9E15-L | 9 | 75 | 11 | 15 | 79 | 76 | 60 | 53 | 44 | 35 | 34 | 26 |
| 2 | 6W10E15 | 150W10E15 150W10E15-LX | 10 | 75 | 11 | 15 | 88 | 84 | 67 | 59 | 49 | 39 | 38 | 29 |
| 3 | 6W12E17.5 | 150W12E17.5 150W12E17.5-LX | 12 | 75 | 13 | 17.5 | 98 | 92 | 71 | 61 | 50 | 40 | 44 | 30 |

| Sr. No. | Rating ISI | Rating ISI | No. Of Stages | Outlet Size mm | Motor | | Discharge in LPM | | | | | | | |
|--|------------|-------------|---------------|----------------|-------|------|----------------------|-----|-----|-----|-----|-----|-----|------|
| | 6W-E | 150W-E | | | kW | HP | 420 | 495 | 690 | 750 | 810 | 870 | 930 | 1050 |
| 150mm Mixed Flow Submersible Pump | | | | | | | Head in Meter | | | | | | | |
| 4 | 6W14E20 | 150W14E20 | 14 | 75 | 15 | 20 | 125 | 108 | 82 | 73 | 60 | 48 | 54 | 32 |
| 5 | 6W16E22.5 | 150W16E22.5 | 16 | 75 | 16.8 | 22.5 | 130 | 120 | 90 | 77 | 61 | 49 | 57 | 33 |
| 6 | 6W18E27.5 | 150W18E27.5 | 18 | 75 | 20.5 | 27.5 | 158 | 152 | 120 | 106 | 88 | 70 | 58 | 52 |
| 7 | 6W20E30 | 150W20E30 | 20 | 75 | 22.4 | 30 | 176 | 168 | 134 | 118 | 98 | 78 | 60 | 58 |

| Sr. No. | Rating ISI | Rating ISI | No. Of Stages | Outlet Size mm | Motor | | Discharge in LPM | | | | | | | |
|--|------------|-------------|---------------|----------------|-------|------|----------------------|-----|-----|-----|-----|-----|-----|--|
| | 6W-F | 150W-F | | | kW | HP | 480 | 650 | 720 | 780 | 840 | 900 | 960 | |
| 150mm MIXED FLOW SUBMERSIBLE PUMP | | | | | | | Head in Meter | | | | | | | |
| 8 | 6W9F15 | 150W9F15 | 9 | 75 | 11 | 15 | 83 | 71 | 64 | 55 | 48 | 40 | 33 | |
| 9 | 6W10F17.5 | 150W10F17.5 | 10 | 75 | 13 | 17.5 | 92 | 79 | 74 | 66 | 56 | 48 | 38 | |
| 10 | 6W12F20 | 150W12F20 | 12 | 75 | 15 | 20 | 112 | 97 | 86 | 76 | 66 | 56 | 46 | |
| 11 | 6W14F25 | 150W14F25 | 14 | 75 | 18.7 | 25 | 128 | 113 | 98 | 88 | 76 | 66 | 54 | |
| 12 | 6W16F27.5 | 150W16F27.5 | 16 | 75 | 20.6 | 27.5 | 150 | 129 | 116 | 104 | 90 | 78 | 64 | |
| 13 | 6W18F30 | 150W18F30 | 18 | 75 | 22.5 | 30 | 166 | 145 | 128 | 110 | 96 | 80 | 66 | |

Performance Curve:

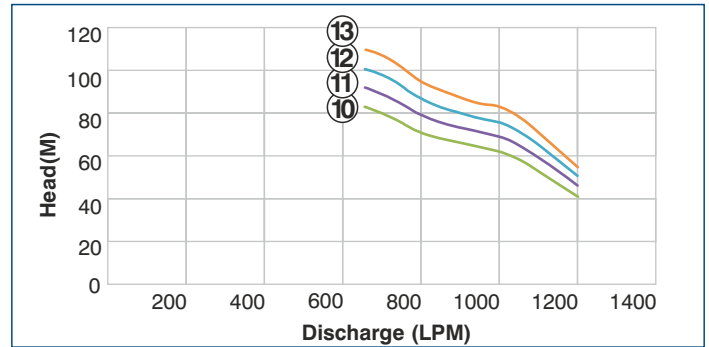
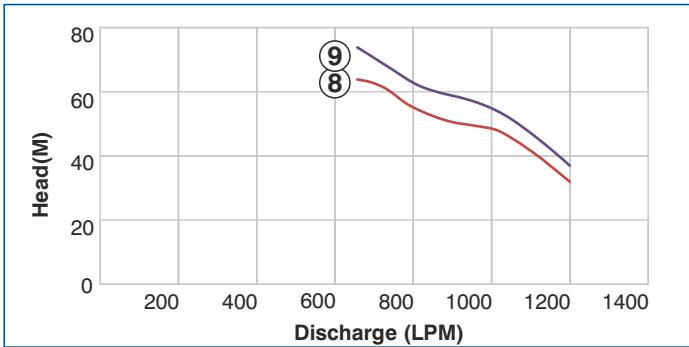
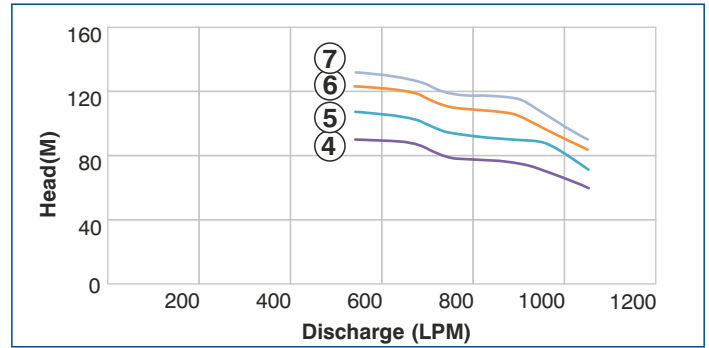
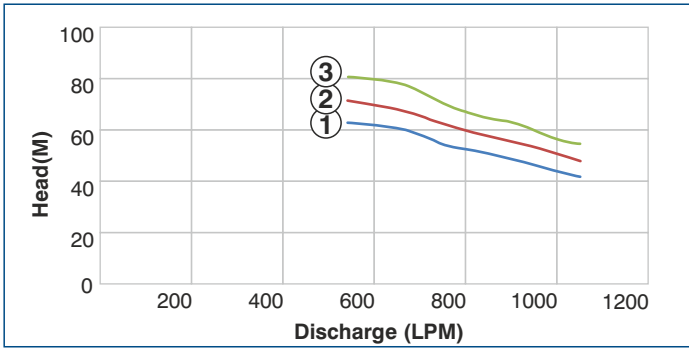

Performance Table:

| Sr. No. | Rating ISI | Rating ISI | No. Of Stages | Outlet Size mm | Motor | | Discharge in LPM | | | | | | |
|--|------------|-------------|---------------|----------------|-------|------|----------------------|-----|-----|-----|-----|-----|------|
| | 6W-G | 150W-G | | | kW | HP | 540 | 660 | 744 | 840 | 900 | 960 | 1050 |
| 150mm Mixed Flow Submersible Pump | | | | | | | Head in Meter | | | | | | |
| 1 | 6W7G15 | 150W7G15 | 7 | 75 | 11 | 15 | 63 | 60 | 55 | 51 | 49 | 46 | 42 |
| 2 | 6W8G15 | 150W8G15 | 8 | 75 | 11 | 15 | 72 | 68 | 63 | 58 | 56 | 53 | 48 |
| 3 | 6W9G17.5 | 150W9G17.5 | 9 | 75 | 13 | 17.5 | 81 | 78 | 71 | 65 | 63 | 59 | 54 |
| 4 | 6W10G20 | 150W10G20 | 10 | 75 | 15 | 20 | 90 | 88 | 79 | 77 | 75 | 70 | 60 |
| 5 | 6W12G25 | 150W12G25 | 12 | 75 | 18.7 | 25 | 108 | 104 | 95 | 92 | 90 | 88 | 72 |
| 6 | 6W14G27.5 | 150W14G27.5 | 14 | 75 | 20.5 | 27.5 | 124 | 120 | 111 | 108 | 105 | 96 | 84 |
| 7 | 6W15G30 | 150W15G30 | 15 | 75 | 22.4 | 30 | 132 | 128 | 119 | 117 | 115 | 105 | 90 |

| Sr. No. | Rating ISI | Rating ISI | No. Of Stages | Outlet Size mm | Motor | | Discharge in LPM | | | | | | |
|--|------------|-------------|---------------|----------------|-------|------|----------------------|-----|-----|-----|------|------|------|
| | 6W-H | 150W-H | | | kW | HP | 660 | 720 | 804 | 930 | 1020 | 1110 | 1200 |
| 150mm Mixed Flow Submersible Pump | | | | | | | Head in Meter | | | | | | |
| 8 | 6W7H17.5 | 150W7H17.5 | 7 | 75 | 13 | 17.6 | 64 | 62 | 55 | 50 | 48 | 41 | 32 |
| 9 | 6W8H20 | 150W8H20 | 8 | 75 | 15 | 20 | 74 | 70 | 63 | 58 | 54 | 46 | 37 |
| 10 | 6W9H22.5 | 150W9H22.5 | 9 | 75 | 16.8 | 22.5 | 83 | 79 | 71 | 65 | 61 | 52 | 41 |
| 11 | 6W10H25 | 150W10H25 | 10 | 75 | 18.7 | 25 | 92 | 88 | 79 | 72 | 68 | 58 | 46 |
| 12 | 6W11H27.5 | 150W11H27.5 | 11 | 75 | 20.5 | 27.5 | 101 | 97 | 87 | 79 | 75 | 64 | 51 |
| 13 | 6W12H30 | 150W12H30 | 12 | 75 | 22 | 30 | 110 | 106 | 95 | 86 | 82 | 70 | 55 |

Performance Curve:

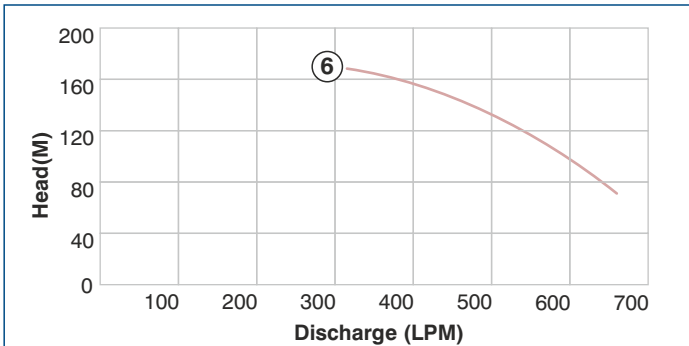
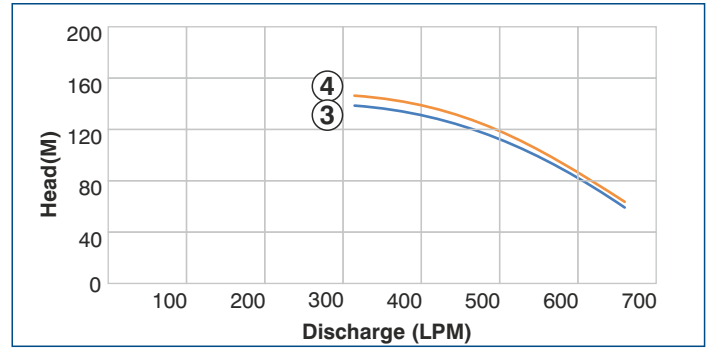
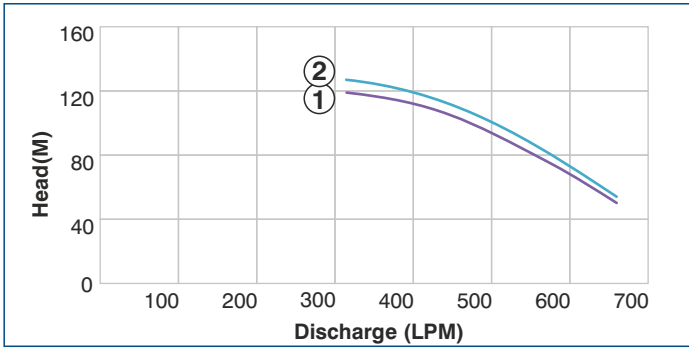

Performance Table:

| Sr. No. | Rating ISI | Rating ISI | No. Of Stages | Outlet Size mm | Motor | | Discharge in LPM | | | | | | |
|---------|-----------------------------------|-------------|---------------|----------------|-------|---------------|------------------|-----|-----|-----|-----|-----|-----|
| | 6W-O | 150W-O | | | kW | HP | 315 | 440 | 444 | 520 | 570 | 620 | 660 |
| | 150mm Mixed Flow Submersible Pump | | | | | Head in Meter | | | | | | | |
| 1 | 6W14O15 | 150W14O15 | 14 | 75 | 11 | 15 | 120 | 112 | 103 | 89 | 77 | 64 | 51 |
| 2 | 6W15O15 | 150W15O15 | 15 | 75 | 11 | 15 | 127 | 120 | 110 | 95 | 82 | 68 | 55 |
| 3 | 6W16O17.5 | 150W16O17.5 | 16 | 75 | 13 | 17.5 | 139 | 132 | 121 | 105 | 90 | 75 | 60 |
| 4 | 6W17O17.5 | 150W17O17.5 | 17 | 75 | 13 | 17.5 | 147 | 140 | 128 | 111 | 95 | 79 | 64 |
| 5 | 6W18O20 | 150W18O20 | 18 | 75 | 15 | 20 | 157 | 149 | 136 | 118 | 101 | 85 | 68 |
| 6 | 6W20O20 | 150W20O20 | 20 | 75 | 15 | 20 | 169 | 157 | 144 | 125 | 107 | 90 | 72 |

Note :

1. The motor ratings in HP are only indicative and for reference purpose
2. Performance figures given above are approximate and may differ on site conditions

3. Performance mentioned on nameplate may vary as we are always improving our products

Pump Dimensional Details:

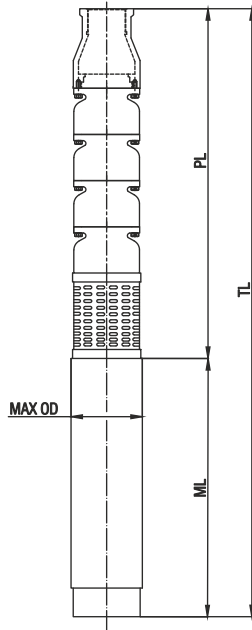

Material of Construction:

| No. | Part | Material |
|-----|---------------------------|------------------------|
| 1 | Diffuser | Cast Iron-Grade FG 200 |
| 2 | Impeller | Stainless Steel |
| 3 | Pump Shaft | Stainless Steel-SS410 |
| 4 | NRV Body | Cast Iron-Grade FG 200 |
| 5 | Motor Body | Stainless Steel-SS202 |
| 6 | Pump Jacket | Cast Iron-Grade FG 200 |
| 7 | Upper Housing, Motor Base | Cast Iron-Grade FG 200 |
| 8 | Bush | Bronze LTB-4 |
| 9 | Motor Shaft | Stainless Steel-SS420 |
| 10 | Stamping | CRNGO-M47 |
| 11 | Thrust Bearing | SS Vs Carbon |
| 12 | Strainer | Stainless Steel-SS202 |
| 13 | Fastener | Stainless Steel-SS410 |
| 14 | Sealing | Oil seal |

| All Dimensions are in mm | | | | |
|--|-----------|------|-------|------------|
| Rating | ML | PL | TL | D |
| | Length mm | | | Max. OD mm |
| | Motor | Pump | Total | |
| 6W30V15/150W30V15 | 1730 | 827 | 2557 | 140.5 |
| 6W26W15/150W26W15 | 1652 | 827 | 2479 | 140.5 |
| 6W28W15/150W28W15 | 1732 | 827 | 2559 | 140.5 |
| 6W30W17.5/150W30W17.5 | 1812 | 887 | 2699 | 140.5 |
| 6W22X15/150W22X15 | 1453 | 827 | 2280 | 140.5 |
| 6W24X15/150W24X15 | 1533 | 827 | 2360 | 140.5 |
| 6W26X17.5/150W26X17.5 | 1613 | 887 | 2500 | 140.5 |
| 6W28X17.5/150W28X17.5 | 1693 | 887 | 2580 | 140.5 |
| 6W30X20/150W30X20 | 1773 | 916 | 2689 | 140.5 |
| 6W32X20/150W32X20 | 1853 | 916 | 2769 | 140.5 |
| 6W34X22.5/150W34X22.5 | 1933 | 985 | 2918 | 140.5 |
| 6W36X22.5/150W36X22.5 | 2013 | 985 | 2998 | 140.5 |
| 6W15R15/150W15R15 | 1177 | 827 | 2004 | 140.5 |
| 6W18R20/150W18R20 | 1327 | 916 | 2243 | 140.5 |
| 6W20R20/150W20R20 | 1427 | 916 | 2343 | 140.5 |
| 6W12D15/150W12D15 | 1448 | 827 | 2275 | 140.5 |
| 6W14D17.5/150W14D17.5 | 1628 | 887 | 2515 | 140.5 |
| 6W15D20/150W15D20 | 1718 | 916 | 2634 | 140.5 |
| 6W16D20/150W16D20 | 1898 | 916 | 2814 | 140.5 |
| 6W18D22.5/150W18D22.5 | 2078 | 916 | 2994 | 140.5 |
| 6W20D25/150W20D25 | 2258 | 985 | 3243 | 140.5 |
| 6W9E15/150W9E15/ 150W9E15-LX | 1195 | 827 | 2022 | 140.5 |
| 6W10E15/150W10E15/ 150W10E15-LX | 1295 | 827 | 2122 | 140.5 |
| 6W12E17.5/150W12E17.5/ 150W12E17.5-LX | 1495 | 887 | 2382 | 140.5 |
| 6W14E20/150W14E20 | 1695 | 916 | 2611 | 140.5 |
| 6W16E22.5/150W16E22.5 | 1895 | 916 | 2811 | 140.5 |

| All Dimensions are in mm | | | | |
|--------------------------|-----------|------|-------|------------|
| Rating | ML | PL | TL | D |
| | Length mm | | | Max. OD mm |
| | Motor | Pump | Total | |
| 6W18E27.5/150W18E27.5 | 2095 | 1060 | 3155 | 140.5 |
| 6W20E30/150W20E30 | 2295 | 1060 | 3355 | 140.5 |
| 6W9F15/150W9F15 | 1295 | 827 | 2122 | 140.5 |
| 6W10F17.5/150W10F17.5 | 1395 | 887 | 2282 | 140.5 |
| 6W12F20/150W12F20 | 1595 | 916 | 2511 | 140.5 |
| 6W14F25/150W14F25 | 1795 | 985 | 2780 | 140.5 |
| 6W16F27.5/150W16F27.5 | 1995 | 985 | 2980 | 140.5 |
| 6W18F30/150W18F30 | 2195 | 1060 | 3255 | 143.5 |
| 6W7G15/150W7G15 | 1009 | 827 | 1836 | 140.5 |
| 6W8G15/150W8G15 | 1112 | 827 | 1939 | 140.5 |
| 6W9G17.5/150W9G17.5 | 1215 | 887 | 2102 | 140.5 |
| 6W10G20/150W10G20 | 1318 | 916 | 2234 | 140.5 |
| 6W12G25/150W12G25 | 1524 | 985 | 2509 | 140.5 |
| 6W14G27.5/150W14G27.5 | 1730 | 1060 | 2790 | 140.5 |
| 6W15G30/150W15G30 | 1833 | 1060 | 2893 | 140.5 |
| 6W6H15/150W6H15 | 906 | 827 | 1733 | 140.5 |
| 6W7H17.5/150W7H17.5 | 1009 | 887 | 1896 | 140.5 |
| 6W8H20/150W8H20 | 1112 | 916 | 2028 | 140.5 |
| 6W9H22.5/150W9H22.5 | 1215 | 985 | 2200 | 140.5 |
| 6W10H25/150W10H25 | 1318 | 985 | 2303 | 140.5 |
| 6W11H27.5/150W11H27.5 | 1421 | 1060 | 2481 | 140.5 |
| 6W12H30/150W12H30 | 1524 | 1060 | 2584 | 140.5 |
| 6W14O15/150W14O15 | 1630 | 827 | 2457 | 140.5 |
| 6W15O15/150W15O15 | 1720 | 827 | 2547 | 140.5 |
| 6W16O17.5/150W16O17.5 | 1810 | 887 | 2697 | 140.5 |
| 6W17O17.5/150W17O17.5 | 1900 | 887 | 2787 | 140.5 |
| 6W18O20/150W18O20 | 1990 | 916 | 2906 | 140.5 |
| 6W20O20/150W20O20 | 2170 | 916 | 3086 | 140.5 |

650CS Series Stainless Steel Borewell Submersible Pumps



High Grade Stainless Steel

Pure SS304 stainless steel construction resists corrosion and withstand tough operating conditions



High Thrust Capacity

Specially designed thrust bearing ensures highest reliability



High Grade Electrical Stampings

Reduced Electrical losses lowers the operating current of the pump



Dynamically Balanced rotating parts:

Minimum vibrations protect components from damage during operation



Easy For Maintenance

Easily replaceable wear & tear Parts, Low maintenance cost

Technical Specifications:

- Range: 3.0HP to 35HP (2.2kW to 26kW)
- Rated voltage: 415V for 3PH
- Voltage range: 250V – 440V
- Rated Frequency: 50Hz
- Delivery pipe size: 65mm
- Max. Head: Upto 590meter
- Max. Discharge: Upto 860LPM
- Liquid: Clear water
- Motor type: Water filled motor

Application:

- Bungalows
- Buildings, Flats
- Hotels
- Garages
- Laundries
- Car Washing & Booster application
- Small Farms & Lawn Sprinklers



Performance Curve:

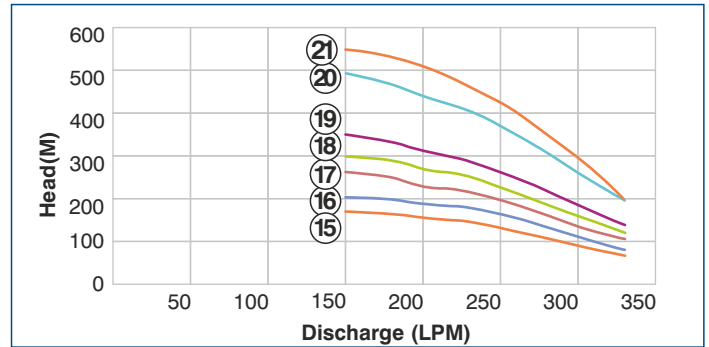
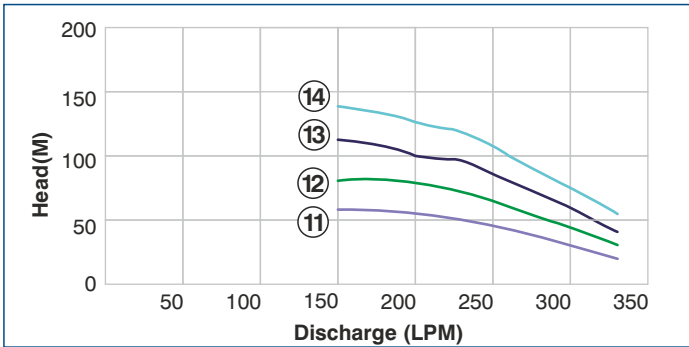
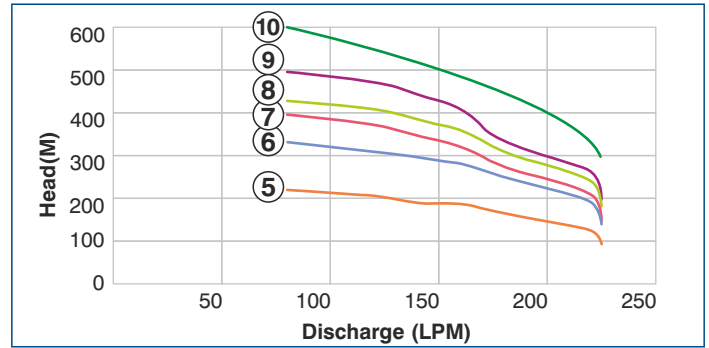
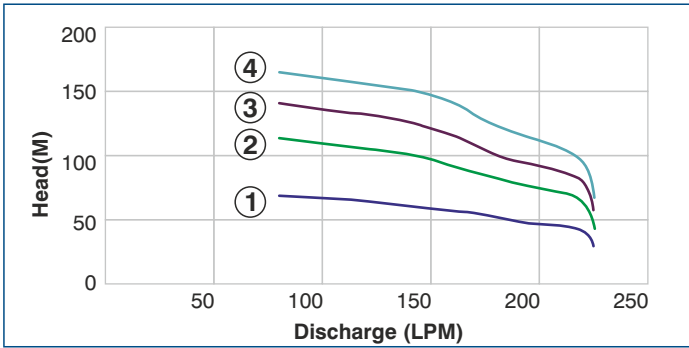

Performance Table:

| Sr. No. | Rating | No. Of Stages | Motor | | Outlet Size mm | Discharge in LPM | | | | | | |
|---------|---------------|---------------|-------|------|----------------|------------------|-----|-----|-----|-----|-----|-----|
| | | | kW | HP | | 80 | 120 | 140 | 160 | 180 | 220 | 225 |
| | | | | | | Head in Meter | | | | | | |
| 1 | 650CS60-0305 | 5 | 2.2 | 3 | 65 | 70 | 65 | 62 | 58 | 52 | 40 | 30 |
| 2 | 650CS60-0508 | 8 | 3.7 | 5 | 65 | 112 | 105 | 100 | 92 | 82 | 65 | 45 |
| 3 | 650CS60-0610 | 10 | 4.5 | 6 | 65 | 140 | 130 | 125 | 115 | 100 | 80 | 60 |
| 4 | 650CS60-7512 | 12 | 5.5 | 7.5 | 65 | 166 | 155 | 152 | 140 | 125 | 95 | 70 |
| 5 | 650CS60-1016 | 16 | 7.5 | 10 | 65 | 220 | 205 | 190 | 186 | 165 | 125 | 95 |
| 6 | 650CS60-1524 | 24 | 11 | 15 | 65 | 332 | 308 | 295 | 280 | 250 | 190 | 140 |
| 7 | 650CS60-17527 | 27 | 13 | 17.5 | 65 | 395 | 370 | 345 | 320 | 275 | 210 | 150 |
| 8 | 650CS60-2030 | 30 | 15 | 20 | 65 | 430 | 410 | 385 | 360 | 310 | 240 | 180 |
| 9 | 650CS60-2534 | 34 | 18.5 | 25 | 65 | 496 | 470 | 442 | 408 | 333 | 262 | 198 |
| 10 | 650CS60-3040 | 40 | 22.5 | 30 | 65 | 600 | 560 | 525 | 490 | 450 | 320 | 300 |

| Sr. No. | Rating | No. Of Stages | Motor | | Outlet Size mm | Discharge in LPM | | | | | | |
|---------|---------------|---------------|-------|------|----------------|------------------|-----|-----|-----|-----|-----|-----|
| | | | kW | HP | | 150 | 180 | 200 | 230 | 270 | 300 | 330 |
| | | | | | | Head in Meter | | | | | | |
| 11 | 650CS80-0304 | 4 | 2.2 | 3 | 65 | 55 | 56 | 52 | 48 | 40 | 32 | 20 |
| 12 | 650CS80-0506 | 6 | 3.7 | 5 | 65 | 82 | 84 | 78 | 72 | 58 | 45 | 32 |
| 13 | 650CS80-0608 | 8 | 4.5 | 6 | 65 | 115 | 110 | 102 | 96 | 78 | 60 | 42 |
| 14 | 650CS80-7510 | 10 | 5.5 | 7.5 | 65 | 140 | 136 | 128 | 120 | 95 | 75 | 55 |
| 15 | 650CS80-1012 | 12 | 7.5 | 10 | 65 | 170 | 165 | 155 | 144 | 115 | 90 | 65 |
| 16 | 650CS80-12515 | 15 | 9.3 | 12.5 | 65 | 205 | 200 | 190 | 180 | 145 | 110 | 80 |
| 17 | 650CS80-1518 | 18 | 11 | 15 | 65 | 265 | 250 | 230 | 216 | 175 | 135 | 105 |
| 18 | 650CS80-17521 | 21 | 13 | 17.5 | 65 | 300 | 290 | 270 | 252 | 200 | 160 | 120 |
| 19 | 650CS80-2024 | 24 | 15 | 20 | 65 | 350 | 332 | 312 | 288 | 235 | 185 | 140 |
| 20 | 650CS80-3034 | 34 | 22.5 | 30 | 65 | 496 | 470 | 442 | 408 | 333 | 262 | 198 |
| 21 | 650CS80-3540 | 40 | 26.0 | 35 | 65 | 550 | 525 | 505 | 460 | 380 | 300 | 200 |

Performance Curve:

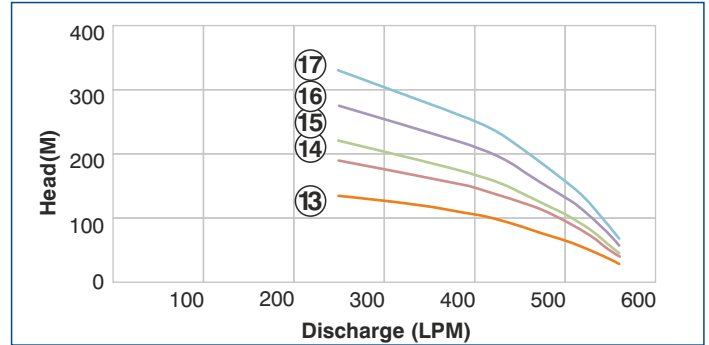
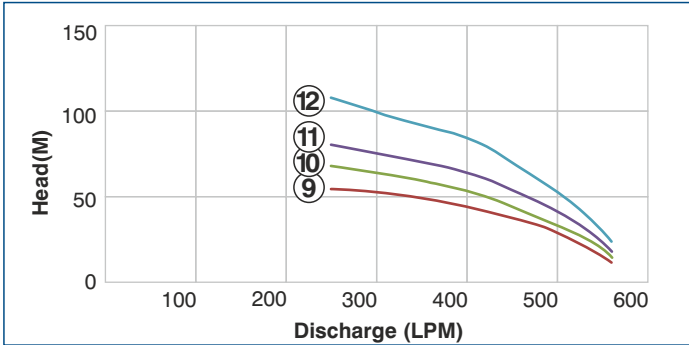
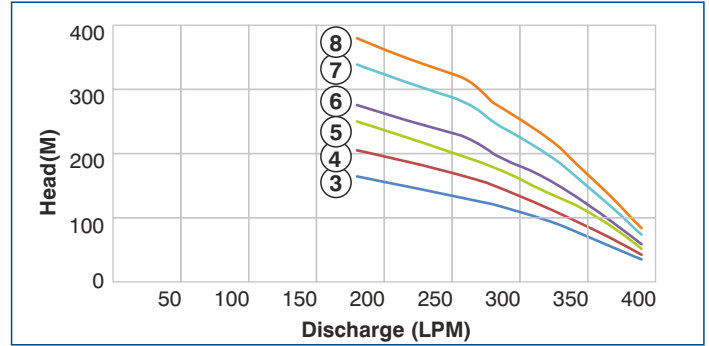
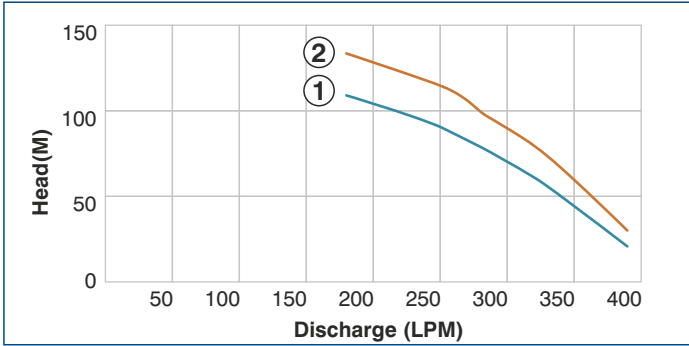

Performance Table:

| Sr. No. | Rating | No. Of Stages | Motor | | Outlet Size mm | Discharge in LPM | | | | | | |
|---------|----------------|---------------|-------|------|----------------|------------------|-----|-----|-----|-----|-----|-----|
| | | | kW | HP | | 180 | 210 | 260 | 280 | 320 | 350 | 390 |
| | | | | | | Head in Meter | | | | | | |
| 1 | 650CS100-7508 | 8 | 5.5 | 7.5 | 65 | 110 | 102 | 88 | 80 | 62 | 45 | 22 |
| 2 | 650CS100-1010 | 10 | 7.5 | 10 | 65 | 135 | 126 | 112 | 100 | 80 | 60 | 30 |
| 3 | 650CS100-12512 | 12 | 9.3 | 12.5 | 65 | 165 | 150 | 130 | 120 | 96 | 70 | 35 |
| 4 | 650CS100-1515 | 15 | 11 | 15 | 65 | 205 | 190 | 162 | 150 | 115 | 86 | 42 |
| 5 | 650CS100-17518 | 18 | 13 | 17.5 | 65 | 250 | 230 | 195 | 180 | 140 | 110 | 52 |
| 6 | 650CS100-2020 | 20 | 15 | 20 | 65 | 275 | 255 | 225 | 200 | 160 | 120 | 60 |
| 7 | 650CS100-2525 | 25 | 18.5 | 25 | 65 | 338 | 315 | 280 | 250 | 200 | 150 | 75 |
| 8 | 650CS100-3028 | 28 | 22 | 30 | 65 | 378 | 353 | 315 | 280 | 225 | 168 | 84 |

| Sr. No. | Rating | No. Of Stages | Motor | | Outlet Size mm | Discharge in LPM | | | | | | |
|---------|----------------|---------------|-------|------|----------------|------------------|-----|-----|-----|-----|-----|-----|
| | | | kW | HP | | 250 | 340 | 380 | 420 | 480 | 520 | 560 |
| | | | | | | Head in Meter | | | | | | |
| 9 | 650CS125-0504 | 4 | 3.7 | 5 | 65 | 54 | 48 | 44 | 40 | 32 | 22 | 10 |
| 10 | 650CS125-0605 | 5 | 4.5 | 6 | 65 | 68 | 60 | 55 | 50 | 36 | 28 | 14 |
| 11 | 650CS125-7506 | 6 | 5.5 | 7.5 | 65 | 80 | 70 | 66 | 60 | 45 | 34 | 16 |
| 12 | 650CS125-1008 | 8 | 7.5 | 10 | 65 | 108 | 94 | 88 | 80 | 60 | 45 | 24 |
| 13 | 650CS125-12510 | 10 | 9.3 | 12.5 | 65 | 135 | 120 | 110 | 100 | 75 | 55 | 28 |
| 14 | 650CS125-17514 | 14 | 13 | 17.5 | 65 | 190 | 165 | 155 | 140 | 110 | 80 | 40 |
| 15 | 650CS125-2016 | 16 | 15 | 20 | 65 | 220 | 190 | 175 | 160 | 120 | 90 | 45 |
| 16 | 650CS125-2520 | 20 | 18.5 | 25 | 65 | 275 | 238 | 219 | 200 | 150 | 113 | 56 |
| 17 | 650CS125-3024 | 24 | 22 | 30 | 65 | 330 | 285 | 263 | 240 | 180 | 135 | 68 |

Performance Curve:

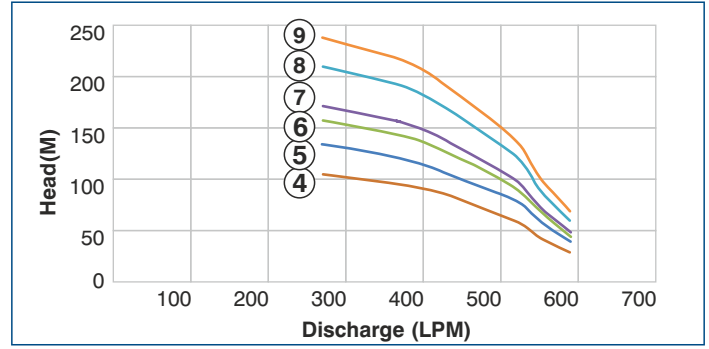
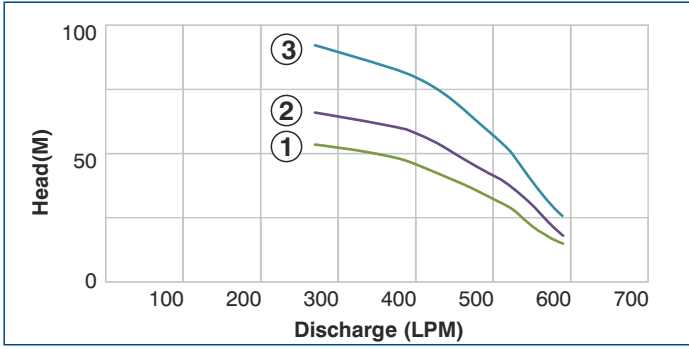

Performance Table:

| Sr. No. | Rating | No. Of Stages | Motor | | Outlet Size mm | Discharge in LPM | | | | | | |
|---------|----------------|---------------|-------|------|----------------|------------------|-----|-----|-----|-----|-----|-----|
| | | | kW | HP | | 270 | 380 | 420 | 450 | 520 | 550 | 590 |
| | | | | | | Head in Meter | | | | | | |
| 1 | 650CS150-0604 | 4 | 4.5 | 6 | 65 | 54 | 48 | 44 | 40 | 30 | 22 | 15 |
| 2 | 650CS150-7505 | 5 | 5.5 | 7.5 | 65 | 66 | 60 | 55 | 50 | 38 | 30 | 18 |
| 3 | 650CS150-1007 | 7 | 7.5 | 10 | 65 | 92 | 82 | 77 | 70 | 52 | 40 | 26 |
| 4 | 650CS150-12508 | 8 | 9.3 | 12.5 | 65 | 105 | 94 | 88 | 80 | 60 | 45 | 30 |
| 5 | 650CS150-1510 | 10 | 11 | 15 | 65 | 135 | 120 | 110 | 100 | 80 | 60 | 40 |
| 6 | 650CS150-17512 | 12 | 13 | 17.5 | 65 | 158 | 142 | 130 | 120 | 92 | 70 | 45 |
| 7 | 650CS150-2013 | 13 | 15 | 20 | 65 | 172 | 155 | 142 | 130 | 100 | 75 | 50 |
| 8 | 650CS150-2516 | 16 | 18.5 | 25 | 65 | 211 | 190 | 174 | 160 | 123 | 92 | 60 |
| 9 | 650CS150-3018 | 18 | 22 | 30 | 65 | 238 | 214 | 196 | 180 | 138 | 103 | 69 |

Note :

1. The motor ratings in HP are only indicative and for reference purpose
2. Performance figures given above are approximate and may differ on site conditions

3. Performance mentioned on nameplate may vary as we are always improving our products

Material of Construction:

| Sr. No. | Part | Material |
|---------|---------------------------|------------------------|
| 1 | Diffuser | Stainless Steel-SS304 |
| 2 | Impeller | Stainless Steel-SS410 |
| 3 | Pump Shaft | Stainless Steel-SS410 |
| 4 | NRV Body | Cast Iron-Grade FG 200 |
| 5 | Motor Body | Stainless Steel-SS202 |
| 6 | Upper Housing, Motor Base | Cast Iron-Grade FG 200 |
| 7 | Bush | Bronze LTB-4 |
| 8 | Motor Shaft | Stainless Steel-SS420 |
| 9 | Stamping | CRNGO-M47 |
| 10 | Thrust Bearing | SS Vs Carbon |
| 11 | Strainer | Stainless Steel-SS202 |
| 12 | Fastener | Stainless Steel-SS410 |
| 13 | Sealing | Oil seal |

Pump Dimensional Details:

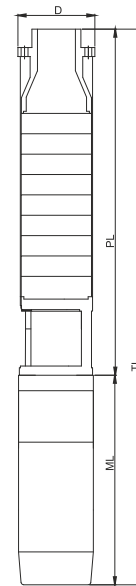

| All Dimensions are in mm | | | | |
|--------------------------|-----------|------|-------|---------------|
| Rating | ML | PL | TL | D |
| | Length mm | | | Max. OD mm |
| | Motor | Pump | Total | |
| 650CS60-0305 | 675 | 446 | 1048 | 146 |
| 650CS60-0508 | 725 | 543 | 1195 | 146 |
| 650CS60-0610 | 745 | 608 | 1280 | 146 |
| 650CS60-7512 | 775 | 673 | 1375 | 146 |
| 650CS60-1016 | 825 | 853 | 2127 | 146 |
| 650CS60-1524 | 939 | 1261 | 2426 | 146 |
| 650CS60-17527 | 959 | 1359 | 2656 | 146 |
| 650CS60-2030 | 1043 | 1456 | 2894 | 146 |
| 650CS60-2534 | 1093 | 1636 | 1031 | 146 |
| 650CS60-3040 | 1140 | 1827 | 1088 | 146 |
| 650CS80-0304 | 675 | 429 | 1154 | 146 |
| 650CS80-0506 | 725 | 502 | 1350 | 146 |
| 650CS80-0608 | 745 | 575 | 1473 | 146 |
| 650CS80-7510 | 775 | 648 | 1785 | 146 |
| 650CS80-1012 | 825 | 721 | 1488 | 146 |
| 650CS80-12515 | 879 | 979 | 1919 | 146 |
| 650CS80-1518 | 939 | 1053 | 2134 | 146 |
| 650CS80-17521 | 959 | 1248 | 2163 | 146 |
| 650CS80-2024 | 1043 | 1357 | 2327 | 146 |
| 650CS80-3034 | 1153 | 1772 | 2852 | 146 |
| 650CS100-7508 | 775 | 599 | 1301 | 146 |
| 650CS100-1010 | 825 | 678 | 1430 | 146 |
| 650CS100-12512 | 879 | 855 | 1661 | 146 |

| All Dimensions are in mm | | | | |
|--------------------------|-----------|------|-------|---------------|
| Rating | ML | PL | TL | D |
| | Length mm | | | Max. OD mm |
| | Motor | Pump | Total | |
| 650CS100-1515 | 939 | 1024 | 1890 | 146 |
| 650CS100-17518 | 959 | 1142 | 2028 | 146 |
| 650CS100-2020 | 1043 | 1221 | 2191 | 146 |
| 650CS100-2525 | 1093 | 1469 | 2489 | 146 |
| 650CS100-3028 | 1153 | 1587 | 2667 | 146 |
| 650CS125-0504 | 725 | 457 | 1109 | 146 |
| 650CS125-0605 | 745 | 501 | 1173 | 146 |
| 650CS125-7506 | 775 | 544 | 1246 | 146 |
| 650CS125-1008 | 825 | 631 | 1622 | 146 |
| 650CS125-12510 | 879 | 816 | 1769 | 146 |
| 650CS125-17514 | 959 | 1040 | 2097 | 146 |
| 650CS125-2016 | 1043 | 1127 | 2321 | 146 |
| 650CS125-2520 | 1093 | 1301 | 2605 | 146 |
| 650CS125-3024 | 1153 | 1525 | 1000 | 146 |
| 650CS150-0604 | 745 | 473 | 1223 | 146 |
| 650CS150-7505 | 775 | 521 | 1368 | 146 |
| 650CS150-1007 | 825 | 616 | 1567 | 146 |
| 650CS150-12508 | 879 | 761 | 1722 | 146 |
| 650CS150-1510 | 939 | 856 | 1837 | 146 |
| 650CS150-17512 | 959 | 951 | 1969 | 146 |
| 650CS150-2013 | 1043 | 999 | 2211 | 146 |
| 650CS150-2516 | 1093 | 1191 | 2216 | 146 |
| 650CS150-3018 | 1153 | 1136 | 964 | 146 |

V6-V7/ V6-V8 Janta Series Borewell Submersible Pumps



High Grade Electrical Stampings

Reduced Electrical losses lowers the operating current of the pump



Wide Voltage application

Designed to withstand wide voltage fluctuations from 250V-440V & Provides Consistent Performance



Lower Operating Current

Robust Electrical Design Ensures Lower Electrical Current and Lower Power Bill



High Thrust Capacity

Specially designed thrust bearing ensures highest reliability



Easy For Maintenance

Easily replaceable wear & tear Parts, Low maintenance cost

Technical Specifications:

- Range: 4.0HP to 25HP (3.0kW to 18.5kW)
- Rated voltage: 415V for 3PH
- Voltage range: 250V – 440V
- Rated Frequency: 50Hz
- Delivery pipe size: 100mm & 125mm
- Max. Head: Upto 120meter
- Max. Discharge: Upto 2100LPM
- Liquid: Clear water
- Motor type: Water filled motor

Application:

- Sprinkler irrigation
- Drip irrigation
- Agricultural farms
- Construction sites
- Ornamental Fountains
- Lawn Sprinklers
- Gardening



Performance Curve:

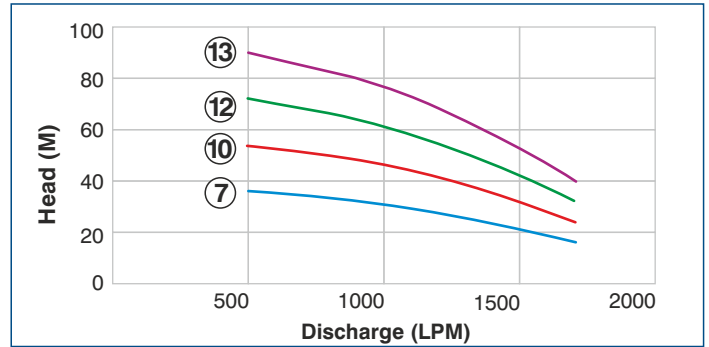
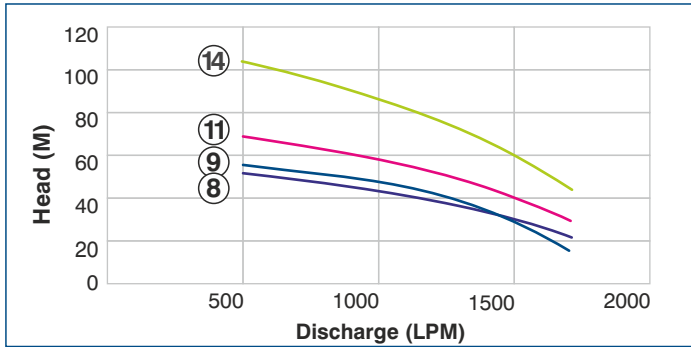
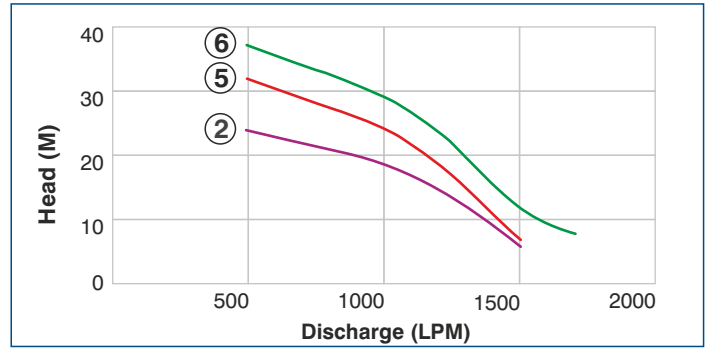
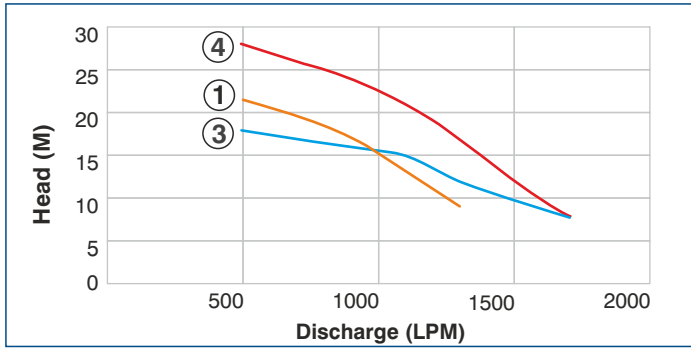

Performance Table:

Performance chart for Borewell Submersible Pump (175 MM)

| Sr. No. | Rating | No. Of Stages | Outlet Size mm | Motor | | Discharge in LPM | | | | | | |
|---------|------------|---------------|----------------|-------|-----|------------------|-----|-----|------|------|------|------|
| | | | | | | 500 | 700 | 900 | 1100 | 1300 | 1500 | 1700 |
| | | | | kW | HP | Head in Meter | | | | | | |
| 1 | J2B4/JS2B4 | 2 | 100 | 3.0 | 4.0 | 21 | 19 | 17 | 13 | 9 | - | - |
| 2 | J2B5/JS2B5 | 2 | 100 | 3.7 | 5.0 | 24 | 22 | 20 | 17 | 12 | 6 | - |
| 3 | J1B6/JS1B6 | 1 | 100 | 4.5 | 6.0 | 18 | 17 | 16 | 15 | 12 | 10 | 8 |
| 4 | J2B6/JS2B6 | 2 | 100 | 4.5 | 6.0 | 28 | 26 | 24 | 21 | 17 | 12 | 8 |

| Sr. No. | Rating | No. Of Stages | Outlet Size mm | Motor | | Discharge in LPM | | | | | | |
|---------|----------------|---------------|----------------|-------|------|------------------|-----|-----|------|------|------|------|
| | | | | | | 500 | 700 | 900 | 1100 | 1300 | 1500 | 1700 |
| | | | | kW | HP | Head in Meter | | | | | | |
| 5 | J3B6/JS3B6 | 3 | 100 | 4.5 | 6.0 | 32 | 29 | 26 | 22 | 15 | 7 | - |
| 6 | J3B7.5/JS3B7.5 | 3 | 100 | 5.5 | 7.5 | 37 | 34 | 31 | 27 | 20 | 12 | 8 |
| 7 | J2B10/JS2B10 | 2 | 100 | 7.5 | 10.0 | 36 | 34 | 32 | 29 | 25 | 21 | 16 |

| Sr. No. | Rating | No. Of Stages | Outlet Size mm | Motor | | Discharge in LPM | | | | | | |
|---------|--------------------|---------------|----------------|-------|------|------------------|-----|-----|------|------|------|------|
| | | | | | | 500 | 700 | 900 | 1100 | 1300 | 1500 | 1700 |
| | | | | kW | HP | Head in Meter | | | | | | |
| 8 | J3B12.5/JS3B12.5 | 3 | 100 | 9.3 | 12.5 | 52 | 49 | 45 | 41 | 36 | 30 | 22 |
| 9 | J4B12.5/JS4B12.5 | 4 | 100 | 9.3 | 12.5 | 55 | 53 | 48 | 42 | 34 | 24 | 16 |
| 10 | J3B15/J3B15-WX | 3 | 100 | 11.0 | 15.0 | 54 | 51 | 48 | 44 | 38 | 32 | 24 |
| 11 | J4B17.5/J4B17.5-WX | 4 | 100 | 13.0 | 17.5 | 69 | 65 | 60 | 55 | 48 | 40 | 29 |
| 12 | J4B20/J4B20-WX | 4 | 100 | 15.0 | 20.0 | 72 | 68 | 64 | 58 | 50 | 42 | 32 |
| 13 | J5B25/J5B25-WX | 5 | 100 | 18.5 | 25.0 | 90 | 85 | 80 | 73 | 63 | 53 | 40 |
| 14 | J6B25/J6B25-WX | 6 | 100 | 18.5 | 25.0 | 104 | 98 | 90 | 82 | 72 | 60 | 44 |

Performance Curve:

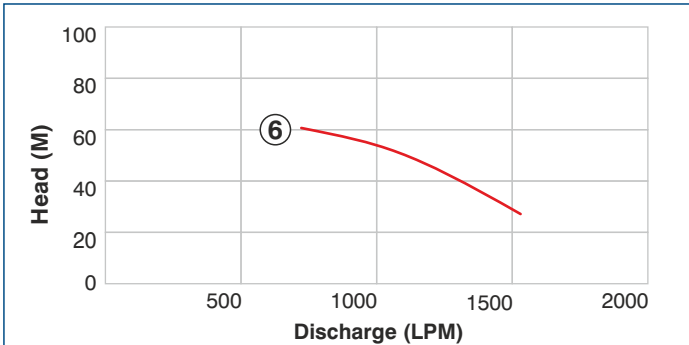
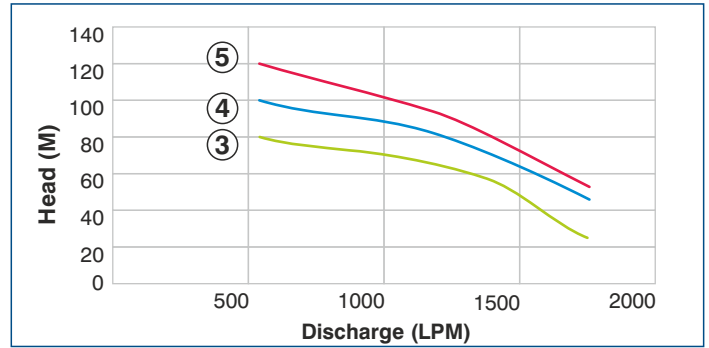
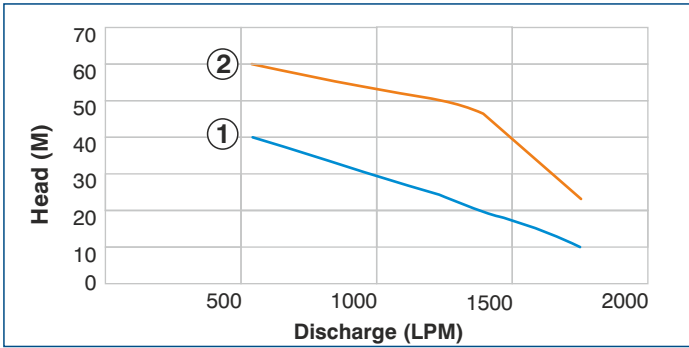

Performance Table:

| Sr. No. | Rating | No. Of Stages | Outlet Size mm | Motor | | Discharge in LPM | | | | | | |
|---------|----------------|---------------|----------------|-------|------|------------------|-----|-----|------|------|------|------|
| | | | | | | 550 | 750 | 950 | 1150 | 1350 | 1550 | 1750 |
| | | | | kW | HP | Head in Meter | | | | | | |
| 1 | J2B7.5/JS2B7.5 | 2 | 100 | 5.5 | 7.5 | 40 | 38 | 33 | 30 | 26 | 22 | 18 |
| 2 | J3B10/JS3B10 | 3 | 100 | 7.5 | 10.0 | 60 | 57 | 50 | 45 | 39 | 33 | 24 |
| 3 | J4B15/J4B15-WX | 4 | 100 | 11.0 | 15.0 | 80 | 76 | 66 | 60 | 52 | 44 | 36 |

| Sr. No. | Rating | No. Of Stages | Outlet Size mm | Motor | | Discharge in LPM | | | | | | |
|---------|--------------------|---------------|----------------|-------|------|------------------|-----|-----|------|------|------|------|
| | | | | | | 550 | 750 | 950 | 1150 | 1350 | 1550 | 1750 |
| | | | | kW | HP | Head in Meter | | | | | | |
| 4 | J5B17.5/J5B17.5-WX | 5 | 100 | 13.0 | 17.5 | 100 | 95 | 82 | 75 | 65 | 55 | 45 |
| 5 | J5B20/J5B20-WX | 5 | 100 | 15.0 | 20.0 | 120 | 114 | 99 | 90 | 78 | 66 | 54 |

Performance chart for Borewell Submersible Pump (200 MM)

| Sr. No. | Rating | No. Of Stages | Outlet Size mm | Motor | | Discharge in LPM | | | | | | |
|---------|----------------|---------------|----------------|-------|------|------------------|-----|------|------|------|------|------|
| | | | | | | 725 | 825 | 1175 | 1200 | 1325 | 1425 | 1525 |
| | | | | kW | HP | Head in Meter | | | | | | |
| 6 | J3K15/J3K15-WX | 3 | 100 | 11.0 | 15.0 | 60 | 57 | 50 | 45 | 39 | 33 | 27 |

Performance Curve:

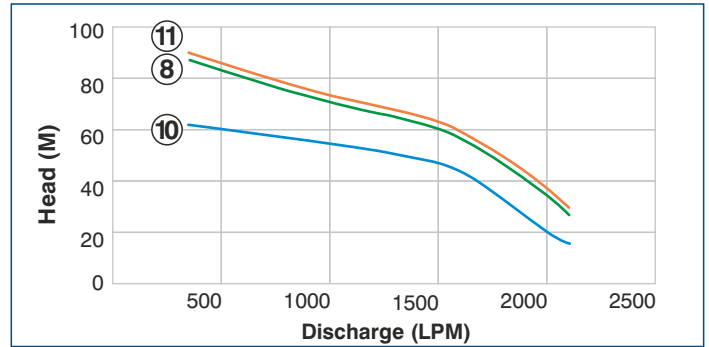
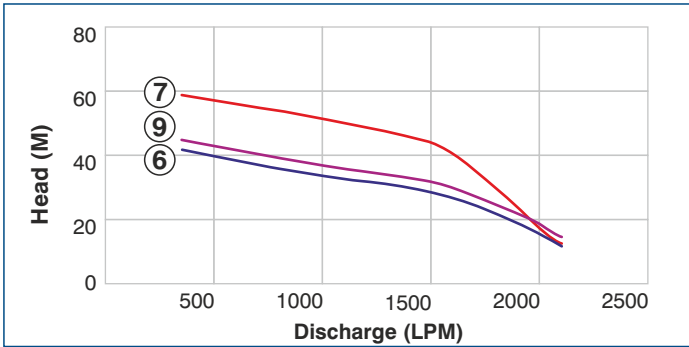
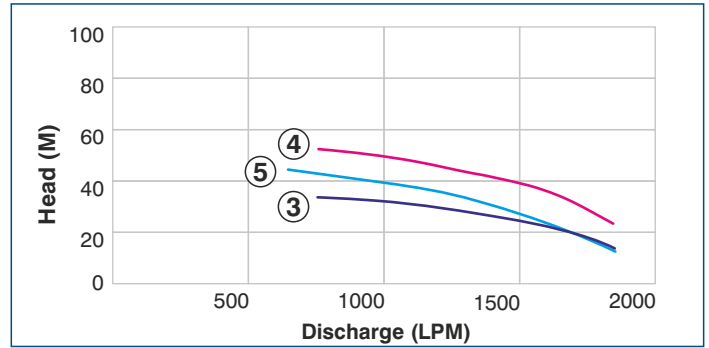
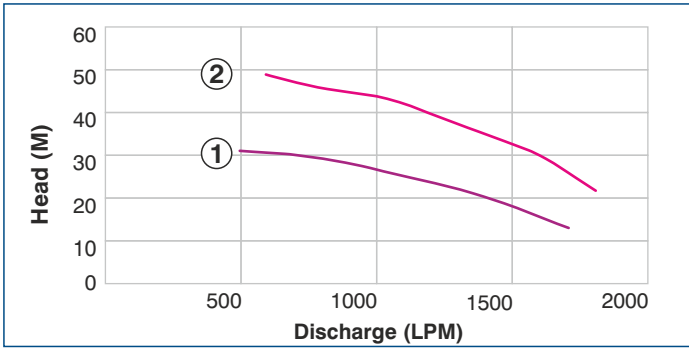

Performance Table:

| Sr. No. | Rating | No. Of Stages | Outlet Size mm | Motor | | Discharge in LPM | | | | | | |
|---------|----------------|---------------|----------------|-------|-----|------------------|-----|-----|------|------|------|------|
| | | | | kW | HP | 500 | 700 | 900 | 1100 | 1300 | 1500 | 1700 |
| | | | | | | Head in Meter | | | | | | |
| 1 | J2A7.5/JS2A7.5 | 2 | 100 | 5.5 | 7.5 | 31 | 30 | 28 | 25 | 22 | 18 | 13 |

| Sr. No. | Rating | No. Of Stages | Outlet Size mm | Motor | | Discharge in LPM | | | | | | |
|---------|---------|---------------|----------------|-------|------|------------------|-----|------|------|------|------|------|
| | | | | kW | HP | 600 | 800 | 1000 | 1200 | 1400 | 1600 | 1800 |
| | | | | | | Head in Meter | | | | | | |
| 2 | J3A12.5 | 3 | 100 | 9.3 | 12.5 | 49 | 46 | 44 | 40 | 35 | 30 | 22 |

| Sr. No. | Rating | No. Of Stages | Outlet Size mm | Motor | | Discharge in LPM | | | | | | |
|---------|--------------|---------------|----------------|-------|------|------------------|-----|------|------|------|------|------|
| | | | | kW | HP | 760 | 940 | 1120 | 1300 | 1480 | 1660 | 1840 |
| | | | | | | Head in Meter | | | | | | |
| 3 | J2A10/JS2A10 | 2 | 100 | 7.5 | 10.0 | 34 | 33 | 31 | 28 | 25 | 21 | 14 |
| 4 | LJ3K15 | 3 | 100 | 11.0 | 15.0 | 53 | 51 | 48 | 44 | 40 | 34 | 24 |

| Sr. No. | Rating | No. Of Stages | Outlet Size mm | Motor | | Discharge in LPM | | | | | | |
|---------|--------------|---------------|----------------|-------|----|------------------|-----|------|------|------|------|------|
| | | | | kW | HP | 650 | 850 | 1050 | 1250 | 1450 | 1650 | 1850 |
| | | | | | | Head in Meter | | | | | | |
| 5 | J3A10/JS3A10 | 3 | 100 | 7.5 | 10 | 45 | 42 | 39 | 35 | 29 | 22 | 13 |

| Sr. No. | Rating | No. Of Stages | Outlet Size mm | Motor | | Discharge in LPM | | | | | | |
|---------|-----------------------------|---------------|----------------|-------|------|------------------|-----|------|------|------|------|------|
| | | | | kW | HP | 350 | 900 | 1400 | 1600 | 1900 | 2025 | 2100 |
| | | | | | | Head in Meter | | | | | | |
| 6 | J2L10/JS2L10 | 2 | 100 | 7.5 | 10 | 42 | 35 | 30 | 27 | 19 | 15 | 12 |
| 7 | J3L15/J3L15-WX | 3 | 100 | 11 | 15 | 59 | 53 | 46 | 41 | 24 | 16 | 13 |
| 8 | J4L20 | 4 | 100 | 15 | 20 | 87 | 73 | 63 | 57 | 41 | 33 | 27 |
| 9 | J2L12.5/JS2L12.5/J2L12.5-WX | 2 | 100 | 9.3 | 12.5 | 45 | 38 | 33 | 30 | 22 | 18 | 15 |
| 10 | J3L17.5/J3L17.5-WX | 3 | 100 | 13 | 17.5 | 62 | 56 | 49 | 44 | 27 | 19 | 16 |
| 11 | J4L25 | 4 | 100 | 18.5 | 25 | 90 | 76 | 66 | 60 | 44 | 36 | 30 |

Performance Curve:

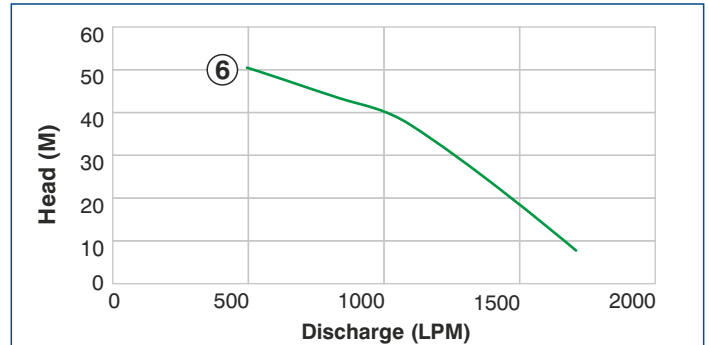
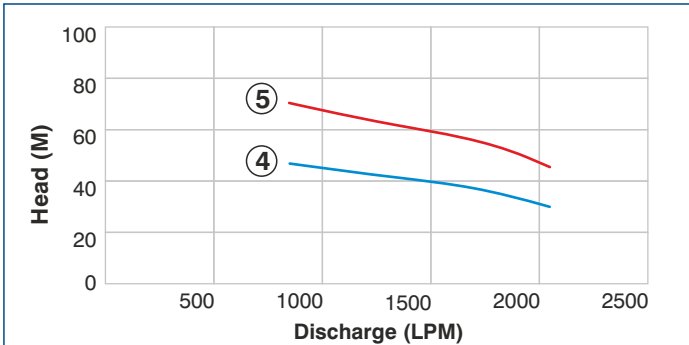
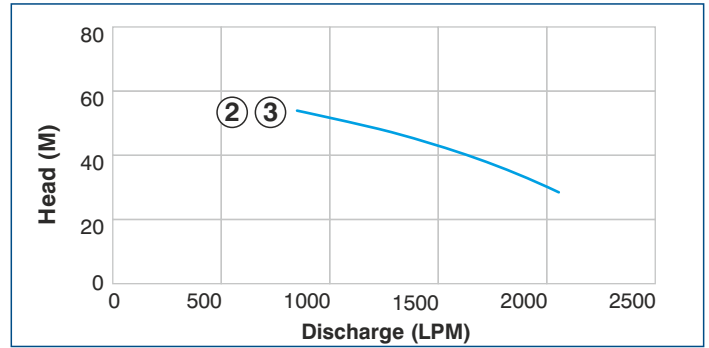
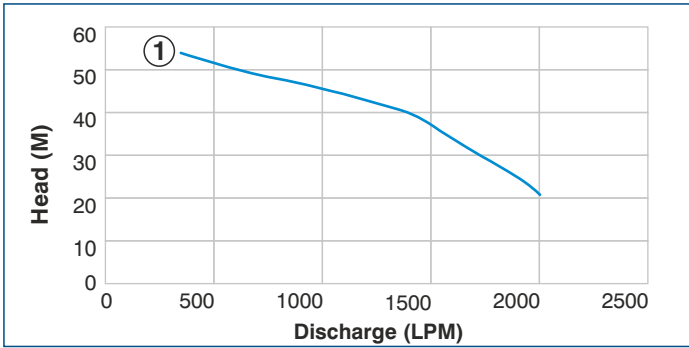

Performance Table:

| Sr. No. | Rating | No. Of Stages | Outlet Size mm | Motor | | Discharge in LPM | | | | | | |
|---------|------------------|---------------|----------------|-------|------|------------------|-----|-----|------|------|------|------|
| | | | | kW | HP | 350 | 700 | 900 | 1400 | 1600 | 1900 | 2000 |
| | | | | | | Head in Meter | | | | | | |
| 1 | J3L12.5/JS3L12.5 | 3 | 100 | 9.3 | 12.5 | 54 | 49 | 47 | 40 | 34 | 25 | 21 |

| Sr. No. | Rating | No. Of Stages | Outlet Size mm | Motor | | Discharge in LPM | | | | | | |
|---------|------------|---------------|----------------|-------|------|------------------|------|------|------|------|------|------|
| | | | | kW | HP | 850 | 1050 | 1250 | 1450 | 1650 | 1850 | 2050 |
| | | | | | | Head in Meter | | | | | | |
| 2 | J3M17.5-WX | 3 | 125 | 13 | 17.5 | 54 | 51 | 48 | 44 | 40 | 35 | 29 |
| 3 | J3M20-WX | 3 | 125 | 15 | 20 | 54 | 51 | 48 | 44 | 40 | 35 | 29 |

| Sr. No. | Rating | No. Of Stages | Outlet Size mm | Motor | | Discharge in LPM | | | | | | |
|---------|----------|---------------|----------------|-------|----|------------------|------|------|------|------|------|------|
| | | | | kW | HP | 850 | 1050 | 1250 | 1450 | 1650 | 1850 | 2050 |
| | | | | | | Head in Meter | | | | | | |
| 4 | J2N15-WX | 2 | 125 | 11 | 15 | 42 | 40 | 38 | 36 | 34 | 31 | 27 |
| 5 | J3N25-WX | 3 | 125 | 18.5 | 25 | 63 | 60 | 57 | 54 | 51 | 47 | 41 |

| Sr. No. | Rating | No. Of Stages | Outlet Size mm | Motor | | Discharge in LPM | | | | | | |
|---------|--------------|---------------|----------------|-------|----|------------------|-----|-----|------|------|------|------|
| | | | | kW | HP | 500 | 700 | 900 | 1100 | 1300 | 1500 | 1700 |
| | | | | | | Head in Meter | | | | | | |
| 6 | J4B10/JS4B10 | 4 | 100 | 7.5 | 10 | 50 | 46 | 42 | 37 | 28 | 18 | 8 |

Note :

1. The motor ratings in HP are only indicative and for reference purpose
2. Performance figures given above are approximate and may differ on site conditions

3. Performance mentioned on nameplate may vary as we are always improving our products

Pump Dimensional Details:

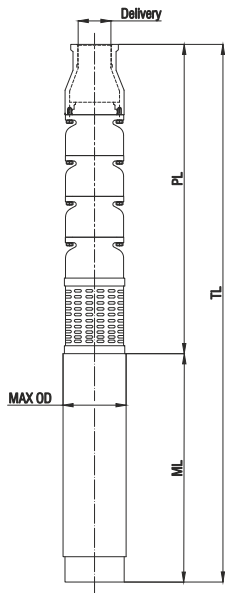

Material of Construction:

| No. | Part | Material |
|-----|---------------------------|------------------------|
| 1 | Diffuser | Cast Iron-Grade FG 200 |
| 2 | Impeller | Stainless Steel-SS410 |
| 3 | Pump Shaft | Stainless Steel-SS410 |
| 4 | NRV Body | Cast Iron-Grade FG 200 |
| 5 | Motor Body | Stainless Steel-SS202 |
| 6 | Upper Housing, Motor Base | Cast Iron-Grade FG 200 |
| 7 | Bush | Bronze LTB-4 |
| 8 | Motor Shaft | Stainless Steel-SS420 |
| 9 | Stamping | CRNGO-M47 |
| 10 | Thrust Bearing | SS Vs Carbon |
| 11 | Strainer | Stainless Steel-SS202 |
| 12 | Fastener | Stainless Steel-SS410 |
| 13 | Sealing | Oil seal |

| All Dimensions are in mm | | | | |
|--------------------------|-----------|------|-------|---------------|
| Rating | ML | PL | TL | D |
| | Length mm | | | Max. OD mm |
| | Motor | Pump | Total | |
| J1B6/JS1B6 | 270 | 569 | 839 | 168 |
| J2B6/JS2B6 | 537 | 569 | 1106 | 168 |
| J2B4/JS2B4 | 537 | 509 | 1046 | 168 |
| J2B5/JS2B5 | 537 | 529 | 1066 | 168 |
| J3B6/JS3B6 | 657 | 656 | 1313 | 168 |
| J3B7.5/JS3B7.5 | 657 | 724 | 1381 | 168 |
| J3B12.5/JS3B12.5 | 657 | 766 | 1423 | 168 |
| J4B17.5/J4B17.5-WX | 777 | 887 | 1664 | 168 |
| J6B25/J6B25-WX | 1017 | 985 | 2002 | 168 |
| J2B10/JS2B10 | 537 | 747 | 1284 | 168 |
| J3B15/J3B15-WX | 657 | 827 | 1484 | 168 |
| J4B20/J4B20-WX | 777 | 916 | 1693 | 168 |
| J5B25/J5B25-WX | 897 | 985 | 1882 | 168 |
| J2B7.5/JS2B7.5 | 537 | 724 | 1261 | 168 |
| J3B10/JS3B10 | 657 | 747 | 1404 | 168 |
| J4B15/J4B15-WX | 777 | 827 | 1604 | 168 |
| J5B17.5/J5B17.5-WX | 897 | 887 | 1784 | 168 |
| J5B20/J5B20-WX | 897 | 916 | 1813 | 168 |
| J3K15/J3K15-WX | 710 | 827 | 1537 | 180 |

| All Dimensions are in mm | | | | |
|--------------------------|-----------|------|-------|---------------|
| Rating | ML | PL | TL | D |
| | Length mm | | | Max. OD mm |
| | Motor | Pump | Total | |
| J2A7.5/JS2A7.5 | 535 | 724 | 1259 | 175 |
| J3A12.5 | 658 | 766 | 1424 | 175 |
| J2A10/JJS2A10 | 535 | 747 | 1282 | 175 |
| LJ3K15 | 658 | 887 | 1545 | 180 |
| J3A10/JS3A10 | 658 | 747 | 1405 | 175 |
| J2L10/JS2L10 | 682 | 747 | 1429 | 180 |
| J4L20 | 682 | 916 | 1598 | 180 |
| J2L12.5/JS2L12.5 | 682 | 766 | 1448 | 180 |
| J3L17.5/J3L17.5-WX | 547 | 887 | 1434 | 180 |
| J4L25 | 682 | 985 | 1667 | 180 |
| J3L12.5/JS3L12.5 | 657 | 766 | 1423 | 180 |
| J3M17.5-WX | 817 | 887 | 1704 | 180 |
| J3M20-WX | 817 | 916 | 1733 | 180 |
| J2N15-WX | 610 | 887 | 1497 | 180 |
| J3N25-WX | 745 | 985 | 1730 | 180 |
| J4B12.5/JS4B12.5 | 897 | 766 | 1663 | 168 |
| J4B10 | 760 | 772 | 1532 | 175 |
| JS4B10 | 720 | 772 | 1492 | 175 |

8W Series Borewell Submersible Pumps



High Grade Electrical Stampings

Reduced Electrical losses lowers the operating current of the pump



Wide Voltage application

Designed to withstand wide voltage fluctuations from 300-440V & Provides Consistent Performance



Lower Operating Current

Robust Electrical Design Ensures Lower Electrical Current and Lower Power Bill



High Thrust Capacity

Specially designed thrust bearing ensures highest reliability



Easy For Maintenance

Easily replaceable wear & tear Parts, Low maintenance cost

Technical Specifications:

- Range: 10HP to 60 HP
- Rated Voltage: 415V
- Voltage Range: 300-440V
- Rated Frequency: 50Hz
- Pipe Size: 100mm
- Max. head: Up to 156 Meters.
- Max. Discharge: Up to 2500 LPM.
- Liquid: Clear Water
- Rotation: Anticlockwise

Application:

- Sprinkler irrigation
- Drip irrigation
- Agricultural farms
- Multistoried Buildings
- Construction sites
- Water supply for Industrial / Commercial Establishment
- Lawn Sprinklers



Performance Curve:

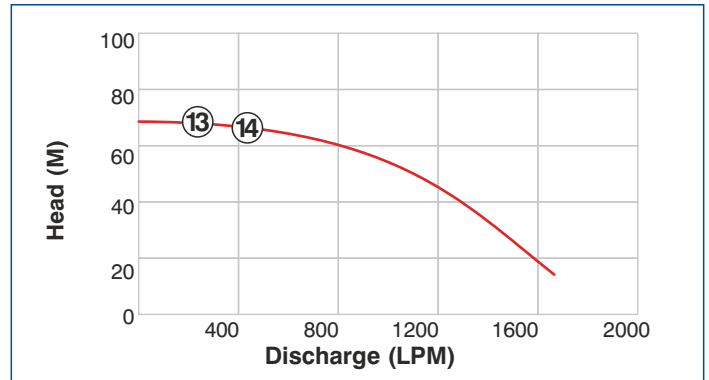
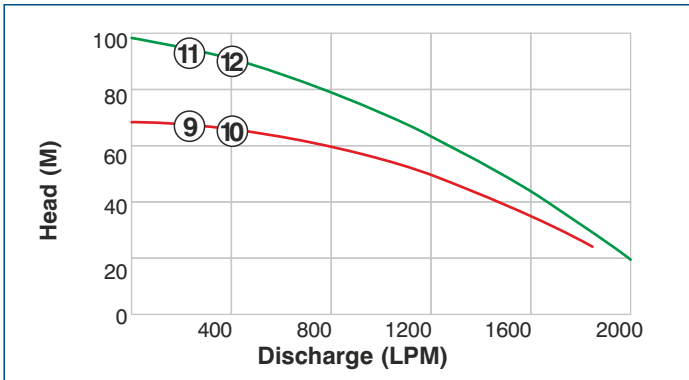
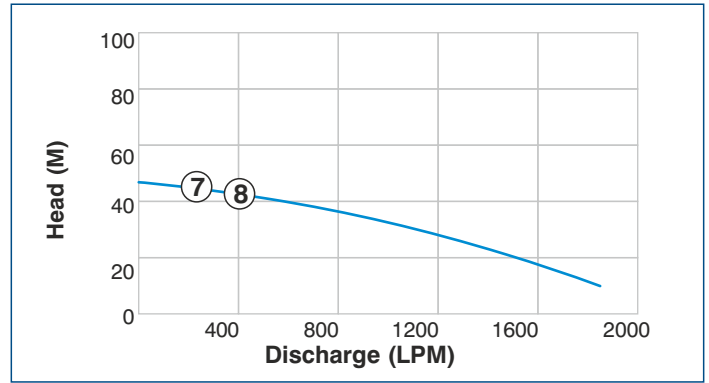
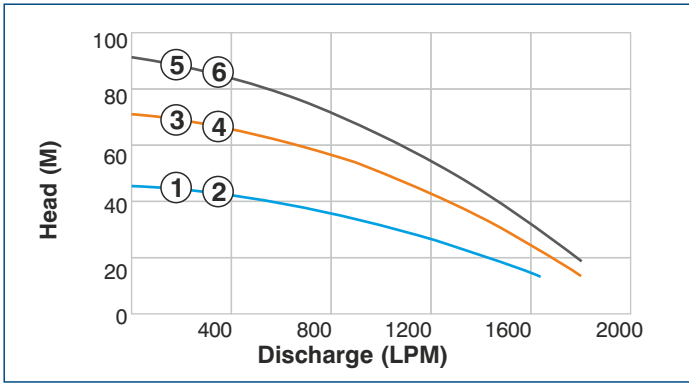

Performance Table:

| Sr. No. | Rating | No. Of Stages | Motor | | Pipe Size | Discharge in LPM | | | | | | | | | |
|---------|-----------|---------------|-------|----|-----------|------------------|-----|-----|-----|------|------|------|------|------|--|
| | | | kW | HP | | 0 | 500 | 700 | 900 | 1050 | 1200 | 1400 | 1640 | 1800 | |
| | | | | | | Head in Meter | | | | | | | | | |
| 1 | 8W2K10D-V | 2 | 7.5 | 10 | 100 | 46 | 40 | 38 | 34 | 31 | 27 | 21 | 13 | - | |
| 2 | 8W2K10D-W | | | | | | | | | | | | | | |
| 3 | 8W3K15D-V | 3 | 11 | 15 | 100 | 72 | 62 | 58 | 54 | 49 | 44 | 34 | 23 | 12 | |
| 4 | 8W3K15D-W | | | | | | | | | | | | | | |
| 5 | 8W4K20D-V | 4 | 15 | 20 | 100 | 92 | 80 | 74 | 68 | 62 | 56 | 44 | 31 | 17 | |
| 6 | 8W4K20D-W | | | | | | | | | | | | | | |

| Sr. No. | Rating | No. Of Stages | Motor | | Pipe Size | Discharge in LPM | | | | | | | | |
|---------|-------------|---------------|-------|-----|-----------|------------------|-----|-----|------|------|------|------|------|------|
| | | | kW | HP | | 0 | 600 | 800 | 1000 | 1210 | 1400 | 1600 | 1850 | 2000 |
| | | | | | | Head in Meter | | | | | | | | |
| 7 | 8W2L12.5D-V | 2 | 9.3 | 125 | 100 | 47 | 40 | 36 | 33 | 29 | 24 | 17 | 10 | - |
| 8 | 8W2L12.5D-W | | | | | | | | | | | | | |
| 9 | 8W3L20D-V | 3 | 15 | 20 | 100 | 70 | 60 | 58 | 55 | 51 | 45 | 38 | 20 | - |
| 10 | 8W3L20D-W | | | | | | | | | | | | | |
| 11 | 8W4L25D-V | 4 | 18.5 | 25 | 100 | 100 | 84 | 78 | 72 | 64 | 55 | 44 | 32 | 16 |
| 12 | 8W4L25D-W | | | | | | | | | | | | | |

| Sr. No. | Rating | No. Of Stages | Motor | | Pipe Size | Discharge in LPM | | | | | | | |
|---------|-------------|---------------|-------|-----|-----------|------------------|-----|-----|-----|------|------|------|------|
| | | | kW | HP | | 0 | 500 | 650 | 800 | 1000 | 1200 | 1400 | 1650 |
| | | | | | | Head in Meter | | | | | | | |
| 13 | 8W3J12.5D-V | 3 | 9.3 | 125 | 100 | 68 | 58 | 54 | 50 | 43 | 35 | 27 | 16 |
| 14 | 8W3J12.5D-W | | | | | | | | | | | | |

Performance Curve:

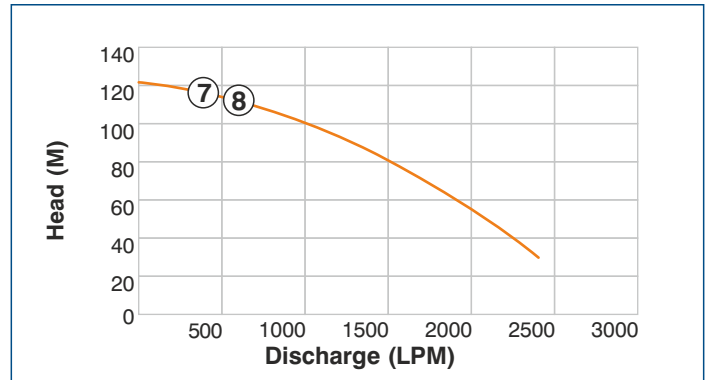
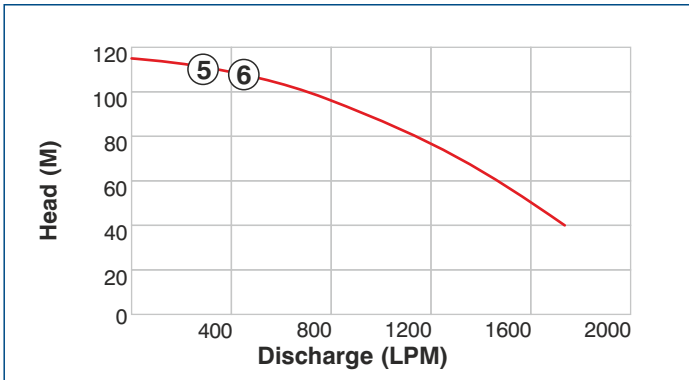
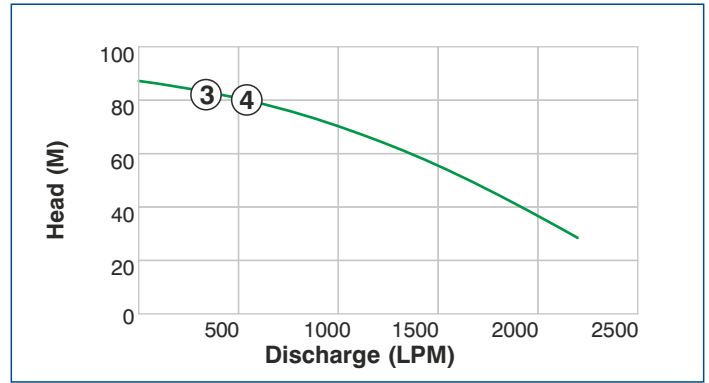
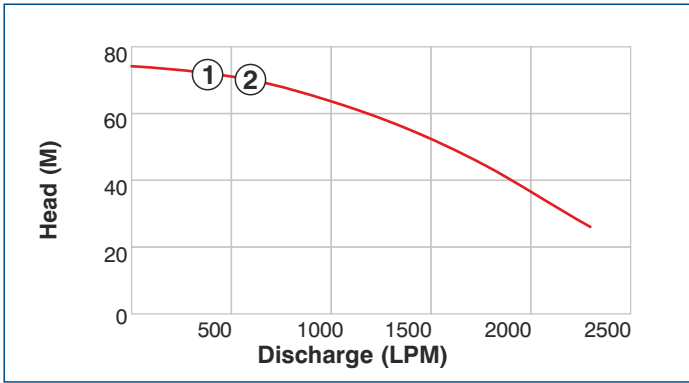

Performance Table:

| Sr. No. | Rating | No. Of Stages | Motor | | Pipe Size | Discharge in LPM | | | | | | | |
|---------|-----------|---------------|-------|----|-----------|------------------|-----|------|------|------|------|------|------|
| | | | kW | HP | | 0 | 600 | 1000 | 1300 | 1700 | 1900 | 2100 | 2300 |
| | | | | | | Head in Meter | | | | | | | |
| 1 | 8W3N25D-V | 3 | 18.5 | 25 | 100 | 75 | 69 | 62 | 58 | 48 | 41 | 34 | 25 |
| 2 | 8W3N25D-W | | | | | | | | | | | | |

| Sr. No. | Rating | No. Of Stages | Motor | | Pipe Size | Discharge in LPM | | | | | | | |
|---------|-----------|---------------|-------|----|-----------|------------------|-----|-----|------|------|------|------|------|
| | | | kW | HP | | 0 | 550 | 820 | 1050 | 1410 | 1700 | 1950 | 2200 |
| | | | | | | Head in Meter | | | | | | | |
| 3 | 8W4M30D-V | 4 | 22.5 | 30 | 100 | 89 | 77 | 72 | 68 | 60 | 51 | 40 | 26 |
| 4 | 8W4M30D-W | | | | | | | | | | | | |

| Sr. No. | Rating | No. Of Stages | Motor | | Pipe Size | Discharge in LPM | | | | | | | | |
|---------|-----------|---------------|-------|----|-----------|------------------|-----|-----|-----|------|------|------|------|------|
| | | | kW | HP | | 0 | 625 | 795 | 995 | 1140 | 1335 | 1480 | 1600 | 1750 |
| | | | | | | Head in Meter | | | | | | | | |
| 5 | 8W5L30D-V | 5 | 22.5 | 30 | 100 | 116 | 104 | 96 | 88 | 80 | 70 | 60 | 50 | 40 |
| 6 | 8W5L30D-W | | | | | | | | | | | | | |

| Sr. No. | Rating | No. Of Stages | Motor | | Pipe Size | Discharge in LPM | | | | | | | | |
|---------|-----------|---------------|-------|----|-----------|------------------|-----|------|------|------|------|------|------|------|
| | | | kW | HP | | 0 | 670 | 1020 | 1320 | 1500 | 1790 | 1980 | 2130 | 2400 |
| | | | | | | Head in Meter | | | | | | | | |
| 7 | 8W5N40D-V | 5 | 30 | 40 | 100 | 124 | 105 | 98 | 89 | 83 | 69 | 60 | 48 | 25 |
| 8 | 8W5N40D-W | | | | | | | | | | | | | |

Performance Curve:

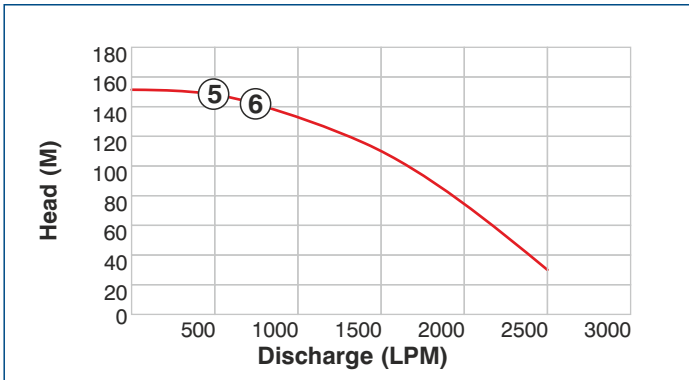
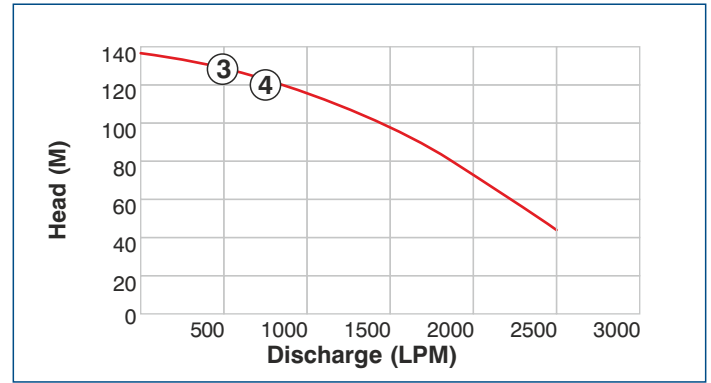
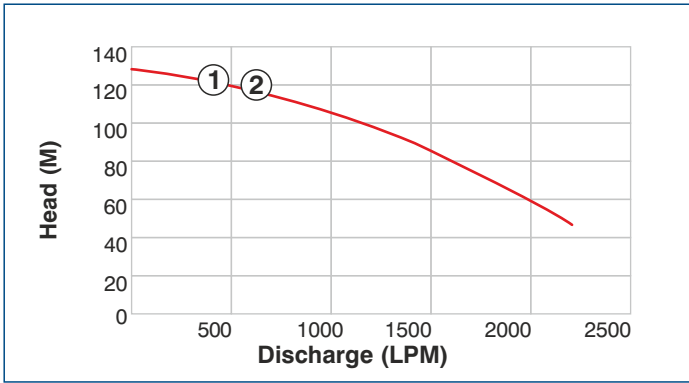

Performance Table:

| Sr. No. | Rating | No. Of Stages | Motor | | Pipe Size | Discharge in LPM | | | | | | | |
|---------|-----------|---------------|-------|----|-----------|------------------|-----|-----|------|------|------|------|------|
| | | | kW | HP | | 0 | 550 | 820 | 1050 | 1410 | 1700 | 1950 | 2200 |
| | | | | | | Head in Meter | | | | | | | |
| 1 | 8W6M45D-V | 6 | 33 | 45 | 100 | 132 | 114 | 107 | 102 | 95 | 80 | 64 | 42 |
| 2 | 8W6M45D-W | | | | | | | | | | | | |

| Sr. No. | Rating | No. Of Stages | Motor | | Pipe Size | Discharge in LPM | | | | | | | | |
|---------|-----------|---------------|-------|----|-----------|------------------|-----|------|------|------|------|------|------|------|
| | | | kW | HP | | 0 | 920 | 1260 | 1570 | 1620 | 1980 | 2140 | 2280 | 2500 |
| | | | | | | Head in Meter | | | | | | | | |
| 3 | 8W5P50D-V | 5 | 37 | 50 | 100 | 138 | 114 | 104 | 96 | 94 | 78 | 66 | 57 | 40 |
| 4 | 8W5P50D-W | | | | | | | | | | | | | |

| Sr. No. | Rating | No. Of Stages | Motor | | Pipe Size | Discharge in LPM | | | | | | | | |
|---------|-----------|---------------|-------|----|-----------|------------------|-----|------|------|------|------|------|------|------|
| | | | kW | HP | | 0 | 920 | 1260 | 1570 | 1620 | 1980 | 2140 | 2280 | 2500 |
| | | | | | | Head in Meter | | | | | | | | |
| 5 | 8W6P60D-V | 6 | 46 | 60 | 100 | 156 | 125 | 120 | 108 | 104 | 81 | 68 | 60 | 15 |
| 6 | 8W6P60D-W | | | | | | | | | | | | | |

Note :

1. The motor ratings in HP are only indicative and for reference purpose
2. Performance figures given above are approximate and may differ on site conditions

3. Performance mentioned on nameplate may vary as we are always improving our products

Material of Construction:

| Sr. No. | Part | Material |
|---------|-------------------|-------------------------|
| 1 | Impeller | Stainless Steel (SS410) |
| 2 | Diffuser | Cast Iron |
| 3 | Stamping material | CRNGO (M47) |
| 4 | Motor shaft | Stainless Steel |
| 5 | Motor base | Cast Iron |
| 6 | Bearing housing | Cast Iron |
| 7 | Pump shaft | Stainless Steel (SS410) |
| 8 | Strainer | Stainless Steel |
| 9 | NRV | Cast Iron |
| 10 | Bearing Bush | Bronze |
| 11 | Fasteners | Stainless Steel (SS410) |
| 12 | Sleeve | Stainless Steel (SS410) |
| 13 | Thrust Bearing | Carbon Vs SS420 |
| 14 | Motor body | Stainless Steel |
| 15 | Adapter | Cast Iron |

Pump Dimensional Details:

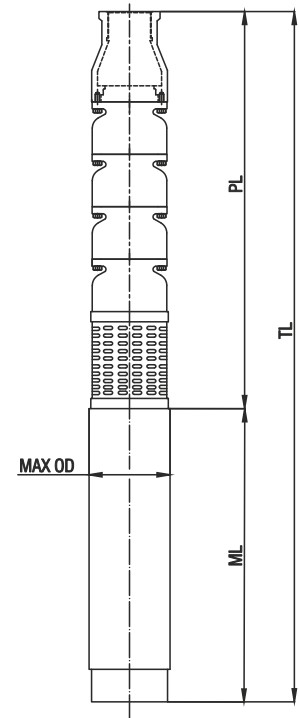

All Dimensions are in mm

| Rating | Length mm | | | Max. OD mm |
|-------------|-----------|-------|-------|------------|
| | PL | ML | TL | |
| | Pump | Motor | Total | |
| 8W2K10D-V | 687 | 880 | 1567 | 190 |
| 8W2K10D-W | 687 | 880 | 1567 | 190 |
| 8W3K15D-V | 807 | 930 | 1737 | 190 |
| 8W3K15D-W | 807 | 930 | 1737 | 190 |
| 8W4K20D-V | 927 | 960 | 1887 | 190 |
| 8W4K20D-W | 927 | 960 | 1887 | 190 |
| 8W2L12.5D-V | 687 | 900 | 1587 | 190 |
| 8W2L12.5D-W | 687 | 900 | 1587 | 190 |
| 8W3L20D-V | 807 | 960 | 1767 | 190 |
| 8W3L20D-W | 807 | 960 | 1767 | 190 |
| 8W4L25D-V | 927 | 1000 | 1927 | 190 |
| 8W4L25D-W | 927 | 1000 | 1927 | 190 |
| 8W3J12.5D-V | 807 | 900 | 1707 | 190 |
| 8W3J12.5D-W | 807 | 900 | 1707 | 190 |

All Dimensions are in mm

| Rating | Length mm | | | Max. OD mm |
|-----------|-----------|-------|-------|------------|
| | PL | ML | TL | |
| | Pump | Motor | Total | |
| 8W3N25D-V | 817 | 1000 | 1817 | 190 |
| 8W3N25D-W | 817 | 1000 | 1817 | 190 |
| 8W4M30D-V | 952 | 1030 | 1982 | 190 |
| 8W4M30D-W | 952 | 1030 | 1982 | 190 |
| 8W5L30D-V | 1047 | 1030 | 2077 | 190 |
| 8W5L30D-W | 1047 | 1030 | 2077 | 190 |
| 8W5N40D-V | 1087 | 1125 | 2212 | 190 |
| 8W5N40D-W | 1087 | 1125 | 2212 | 190 |
| 8W6M45D-V | 1222 | 1170 | 2392 | 190 |
| 8W6M45D-W | 1222 | 1170 | 2392 | 190 |
| 8W5P50D-V | 1087 | 1230 | 2317 | 190 |
| 8W5P50D-W | 1087 | 1230 | 2317 | 190 |
| 8W6P60D-V | 1222 | 1340 | 2562 | 190 |
| 8W6P60D-W | 1222 | 1340 | 2562 | 190 |

10" Borewell Submersible Pumps



High Grade Electrical Stampings

Reduced Electrical losses lowers the operating current of the pump



High Thrust Capacity

Specially designed thrust bearing ensures highest reliability



Lower Operating Current

Robust Electrical Design Ensures Lower Electrical Current and Lower Power Bill



Dynamically Balanced rotating parts:

Minimum vibrations protect components from damage during operation



Easy For Maintenance

Easily replaceable wear & tear Parts, Low maintenance cost

Technical Specifications:

- Range: 25HP to 80HP (18.5kW to 60kW)
- Rated voltage: 415V for 3PH
- Voltage range: 350V - 440V for 3PH
- Rated Frequency: 50Hz
- Delivery pipe size: 150mm
- Max. Head: Upto 150meter
- Max. Discharge: Upto 4000LPM
- Liquid: Clear water
- Motor type: Water filled motor

Application:

- Sprinkler Irrigation
- Drip Irrigation
- Agricultural Farms
- Water supply for Industrial / Commercial Establishment
- Ornamental Fountains
- Lawn Sprinklers



Performance Curve:

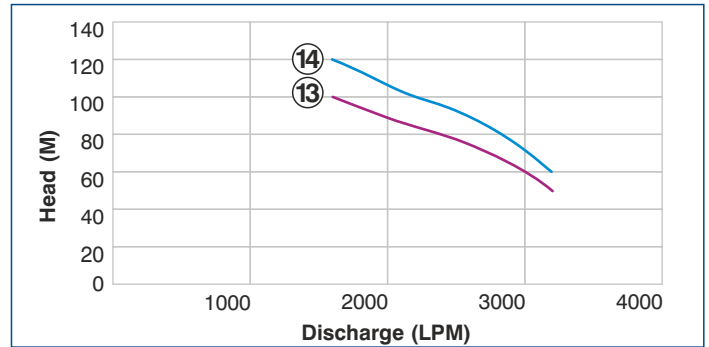
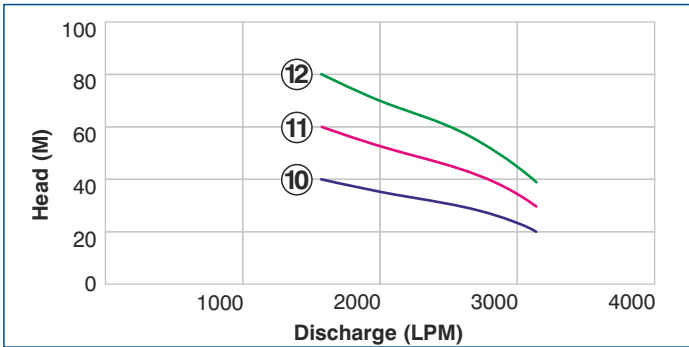
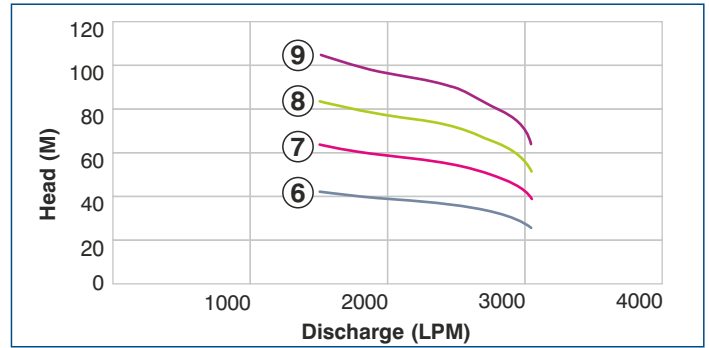
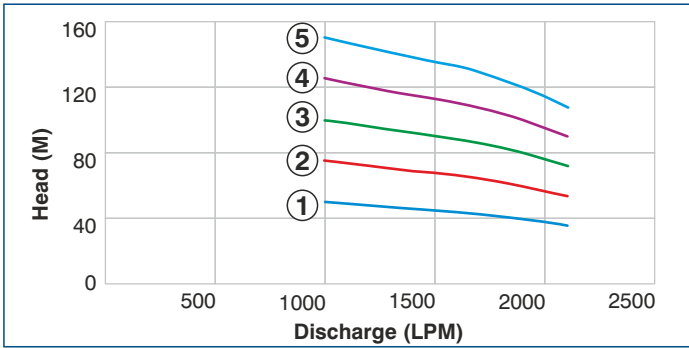

Performance Table:

| Sr. No. | Rating | No. Of Stages | Outlet Size mm | Motor | | Discharge in LPM | | | | | | |
|---------|--------|---------------|----------------|-------|----|------------------|------|------|------|------|------|------|
| | | | | | | 1000 | 1400 | 1625 | 1750 | 1900 | 2000 | 2100 |
| | | | | kW | HP | Head in Meter | | | | | | |
| 1 | D2R25 | 2 | 150 | 18.5 | 25 | 50 | 46 | 44 | 42 | 40 | 38 | 36 |
| 2 | D3R40 | 3 | 150 | 30.0 | 40 | 75 | 69 | 66 | 63 | 60 | 57 | 54 |
| 3 | D4R50 | 4 | 150 | 37.5 | 50 | 100 | 92 | 88 | 84 | 80 | 76 | 72 |
| 4 | D5R65 | 5 | 150 | 48.5 | 65 | 125 | 115 | 110 | 105 | 100 | 95 | 90 |
| 5 | D6R80 | 6 | 150 | 60.0 | 80 | 150 | 138 | 132 | 126 | 120 | 114 | 108 |

| Sr. No. | Rating | No. Of Stages | Outlet Size mm | Motor | | Discharge in LPM | | | | | | |
|---------|--------|---------------|----------------|-------|----|------------------|------|------|------|------|------|------|
| | | | | | | 1500 | 1750 | 2500 | 2650 | 2800 | 2950 | 3050 |
| | | | | kW | HP | Head in Meter | | | | | | |
| 6 | D2S30 | 2 | 150 | 22.5 | 30 | 42 | 40 | 36 | 34 | 32 | 30 | 26 |
| 7 | D3S45 | 3 | 150 | 33.5 | 45 | 63 | 60 | 54 | 51 | 48 | 45 | 39 |
| 8 | D4S60 | 4 | 150 | 45.0 | 60 | 84 | 80 | 72 | 68 | 64 | 60 | 52 |
| 9 | D5S80 | 5 | 150 | 60.0 | 80 | 105 | 100 | 90 | 85 | 80 | 75 | 65 |

| Sr. No. | Rating | No. Of Stages | Outlet Size mm | Motor | | Discharge in LPM | | | | | | |
|---------|--------|---------------|----------------|-------|----|------------------|------|------|------|------|------|------|
| | | | | | | 1600 | 1800 | 2100 | 2400 | 2750 | 3000 | 3200 |
| | | | | kW | HP | Head in Meter | | | | | | |
| 10 | D2Q25 | 2 | 150 | 18.5 | 25 | 40 | 38 | 34 | 32 | 28 | 24 | 20 |
| 11 | D3Q40 | 3 | 150 | 30.0 | 40 | 60 | 57 | 51 | 48 | 42 | 36 | 30 |
| 12 | D4Q50 | 4 | 150 | 37.5 | 50 | 80 | 76 | 68 | 64 | 56 | 48 | 40 |
| 13 | D5Q65 | 5 | 150 | 48.5 | 65 | 100 | 95 | 85 | 80 | 70 | 60 | 50 |
| 14 | D6Q80 | 6 | 150 | 60.0 | 80 | 120 | 114 | 102 | 96 | 84 | 72 | 60 |

Performance Curve:

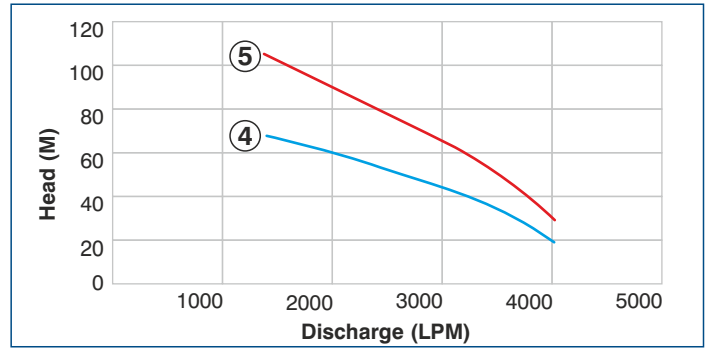
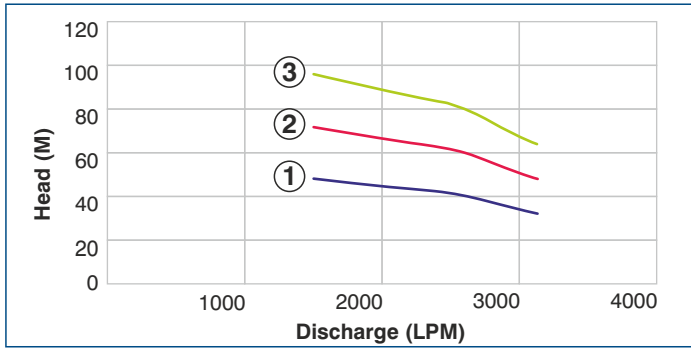

Performance Table:

| Sr. No. | Rating | No. Of Stages | Outlet Size mm | Motor | | Discharge in LPM | | | | | | |
|---------|--------|---------------|----------------|-------|----|------------------|------|------|------|------|------|------|
| | | | | | | 1500 | 2100 | 2450 | 2700 | 2950 | 3100 | 3150 |
| | | | | kW | HP | Head in Meter | | | | | | |
| 1 | D2T40 | 2 | 150 | 30.0 | 40 | 48 | 44 | 42 | 40 | 36 | 34 | 32 |
| 2 | D3T60 | 3 | 150 | 45.0 | 60 | 72 | 66 | 63 | 60 | 54 | 51 | 48 |
| 3 | D4T80 | 4 | 150 | 60.0 | 80 | 96 | 88 | 84 | 80 | 72 | 68 | 64 |

| Sr. No. | Rating | No. Of Stages | Outlet Size mm | Motor | | Discharge in LPM | | | | | | |
|---------|--------|---------------|----------------|-------|----|------------------|------|------|------|------|------|------|
| | | | | | | 1400 | 2000 | 2500 | 2700 | 3200 | 3650 | 4000 |
| | | | | kW | HP | Head in Meter | | | | | | |
| 4 | D2U50 | 2 | 150 | 37.5 | 50 | 68 | 60 | 52 | 48 | 40 | 30 | 20 |
| 5 | D3U75 | 3 | 150 | 55.0 | 75 | 105 | 90 | 78 | 72 | 60 | 45 | 30 |

Note :

- The motor ratings in HP are only indicative and for reference purpose
- Performance figures given above are approximate and may differ on site conditions
- Performance mentioned on nameplate may vary as we are always improving our products
- Motor size is 200 mm (8")

Material of Construction:

| No. | Part | Material |
|-----|---------------------------|------------------------|
| 1 | Diffuser | Cast Iron-Grade FG 200 |
| 2 | Impeller | Stainless Steel-SS410 |
| 3 | Pump Shaft | Stainless Steel-SS410 |
| 4 | NRV Body | Cast Iron-Grade FG 200 |
| 5 | Motor Body | Stainless Steel-SS202 |
| 6 | Upper Housing, Motor Base | Cast Iron-Grade FG 200 |
| 7 | Bush | Bronze LTB-4 |
| 8 | Motor Shaft | Stainless Steel-SS420 |
| 9 | Stamping | CRNGO-M47 |
| 10 | Thrust Bearing | SS Vs Carbon |
| 11 | Strainer | Stainless Steel-SS202 |
| 12 | Fastener | Stainless Steel-SS410 |
| 13 | Sealing | Oil seal |

Pump Dimensional Details:

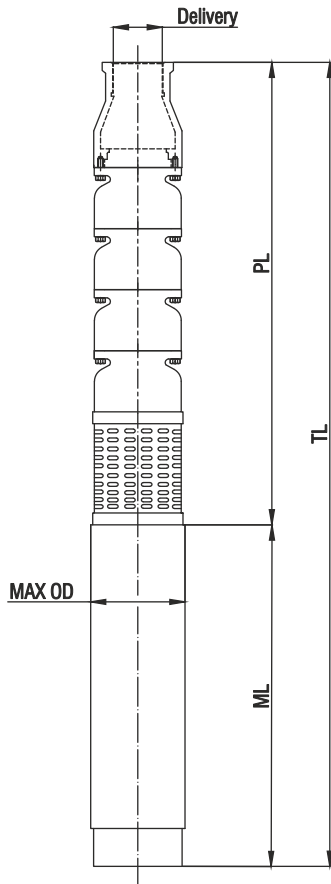

| All Dimensions are in mm | | | | |
|--------------------------|-----------|------|-------|-----|
| Rating | ML | PL | TL | D |
| | Length mm | | | |
| | Motor | Pump | Total | |
| D2R25 | 985 | 820 | 1805 | 240 |
| D3R40 | 1137 | 960 | 2097 | 240 |
| D4R50 | 1216 | 1100 | 2316 | 240 |
| D5R65 | 1284 | 1240 | 2524 | 240 |
| D6R80 | 1388 | 1380 | 2768 | 240 |
| D2S30 | 1038 | 820 | 1858 | 240 |
| D3S45 | 1179 | 960 | 2139 | 240 |
| D4S60 | 1284 | 1100 | 2384 | 240 |
| D5S80 | 1388 | 1240 | 2628 | 240 |
| D2Q25 | 985 | 820 | 1805 | 240 |
| D3Q40 | 1137 | 960 | 2097 | 240 |
| D4Q50 | 1216 | 1100 | 2316 | 240 |
| D5Q65 | 1284 | 1240 | 2524 | 240 |
| D6Q80 | 1388 | 1380 | 2768 | 240 |
| D2T40 | 1137 | 820 | 1957 | 240 |
| D3T60 | 1284 | 960 | 2244 | 240 |
| D4T80 | 1388 | 1100 | 2488 | 240 |
| D2U50 | 1216 | 820 | 2036 | 240 |
| D3U75 | 1338 | 960 | 2298 | 240 |

MB & MI Series Centrifugal Monoset Pumps



High Grade Electrical Stampings

Reduced Electrical losses lower the operating current of the pump



Dynamically Balanced Rotating Parts

Minimum vibrations protect components from damage during operation



Reliable Mechanical Seal

High quality and long life mechanical seal



Easy for Maintenance

Easily replaceable wear & tear Parts, low maintenance cost

Technical Specifications:

- Range : 1HP to 30HP (0.75 kW to 22 kW)
- Rated Voltage : 415V for 3PH
- Voltage Range : 350V-440V
- Rated Frequency: 50Hz
- Pipe Size : 32X25mm to 150X150mm
- Max. head : Upto 72 Meters.
- Max. Discharge : Upto 4246 LPM.
- Liquid : Clear Water

Applications

- Cooling Tower
- Sprinkler Irrigation, Lift irrigation
- Construction sites
- Office & Shopping Mall Cooling System
- Agricultural Farms
- Drip Irrigation



Performance Curve: MB/MI Series

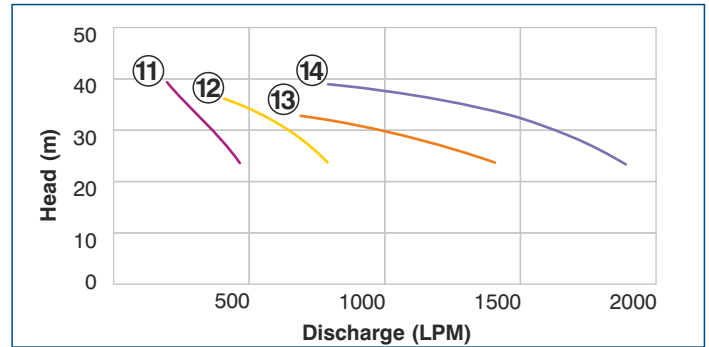
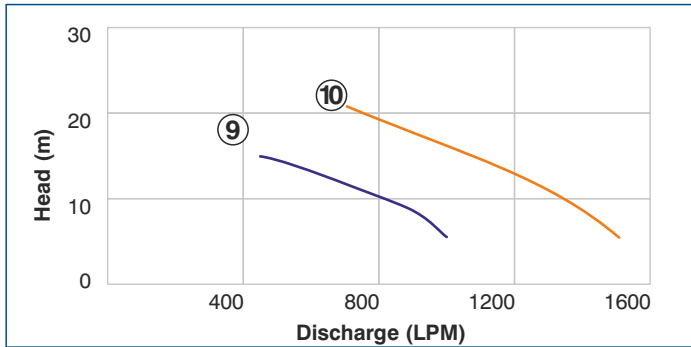
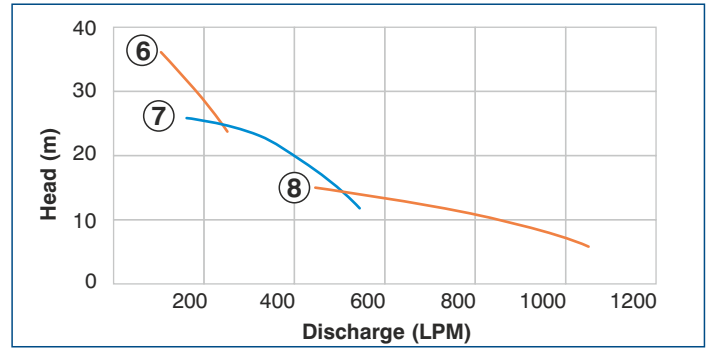
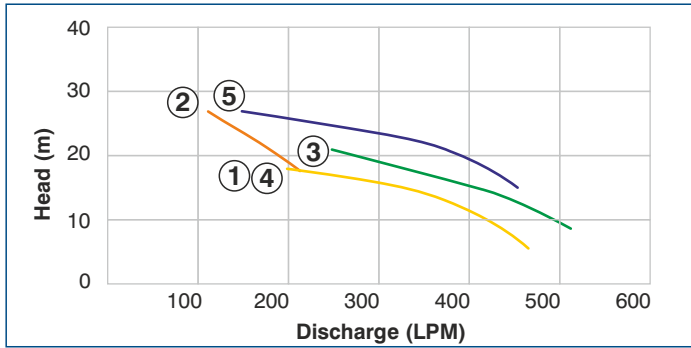

Performance Table: MB/MI Series

| Sr. No. | Rating | Motor | | Pipe Size mm | Head in Meter | | | | | | |
|---------|--------------|-------|-----|--------------|------------------|-----|-----|--------|--------|-----|-----|
| | | | | | 6 | 9 | 12 | 15 | 21 | 24 | 27 |
| | | kW | HP | | Discharge in LPM | | | | | | |
| 1 | MIK22-18 | 1.5 | 2.0 | 50X40 | 460 | 430 | 390 | 330 | 200@18 | - | - |
| 2 | MIKH22-27 | 1.5 | 2.0 | 50X40 | - | - | - | 200@18 | 180 | 145 | 110 |
| 3 | MIN22-21 | 1.5 | 2.0 | 65X50 | - | 510 | 465 | 410 | 250 | - | - |
| 4 | MIK22(HT)-18 | 1.5 | 2.0 | 50X40 | 460 | 430 | 390 | 330 | 200@18 | - | - |
| 5 | MIK32-27 | 2.2 | 3.0 | 50X40 | - | - | - | 450 | 375 | 285 | 150 |

| Sr. No. | Rating | Motor | | Pipe Size mm | Head in Meter | | | | | | | |
|---------|-----------|-------|-----|--------------|------------------|-----|-----|-----|-----|-----|---------|-----|
| | | | | | 6 | 9 | 12 | 15 | 21 | 24 | 27 | 36 |
| | | kW | HP | | Discharge in LPM | | | | | | | |
| 6 | MIKS32-36 | 2.2 | 3.0 | 50X40 | - | - | - | - | - | 250 | 220 | 110 |
| 7 | MIN32-26 | 2.2 | 3.0 | 65X50 | - | - | 540 | 500 | 380 | 300 | 165@26m | - |
| 8 | MIQ32-15 | 2.2 | 3.0 | 80X80 | 1050 | 900 | 720 | 450 | - | - | - | - |

| Sr. No. | Rating | Motor | | Pipe Size mm | Head in Meter | | | | | |
|---------|----------|-------|-----|--------------|------------------|------|------|------|-----|-----|
| | | | | | 6 | 9 | 12 | 15 | 18 | 21 |
| | | kW | HP | | Discharge in LPM | | | | | |
| 9 | MIP32-15 | 2.2 | 3.0 | 80X65 | 1000 | 875 | 720 | 450 | - | - |
| 10 | MIQ52-21 | 3.7 | 5.0 | 80X80 | 1500 | 1350 | 1275 | 1140 | 980 | 700 |

| Sr. No. | Rating | Motor | | Pipe Size mm | Head in Meter | | | | |
|---------|------------|-------|------|--------------|------------------|------|------|------|--------|
| | | | | | 24 | 27 | 30 | 33 | 39 |
| | | kW | HP | | Discharge in LPM | | | | |
| 11 | MIK52-39 | 3.7 | 5.0 | 50X40 | 455 | 415 | 370 | 320 | 200 |
| 12 | MIN7.52-36 | 5.5 | 7.5 | 65X50 | 780 | 715 | 650 | 550 | 420@36 |
| 13 | MIR10.2-33 | 7.5 | 10.0 | 100X80 | 1400 | 1200 | 980 | 700 | - |
| 14 | MIR15.2-39 | 11.0 | 15.0 | 100X80 | 1875 | 1750 | 1615 | 1460 | 800 |

Performance Curve: MB/MI Series

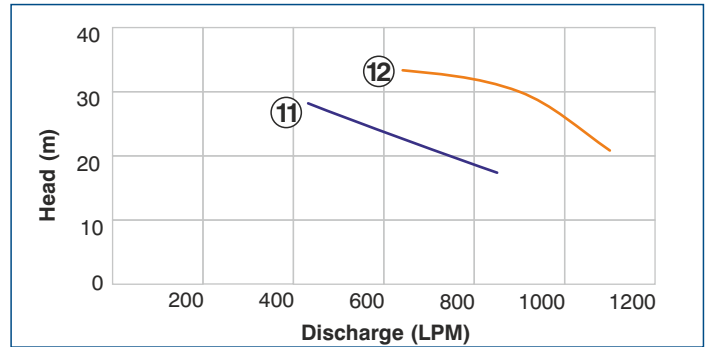
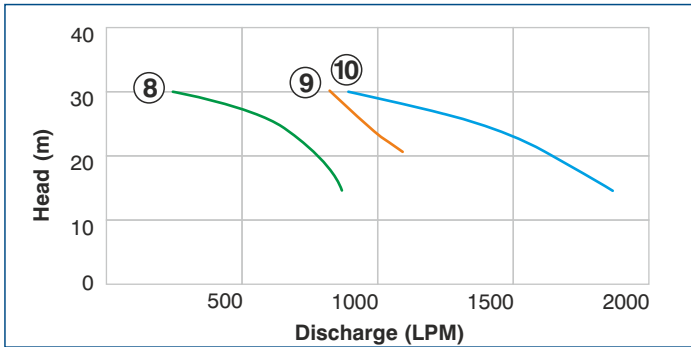
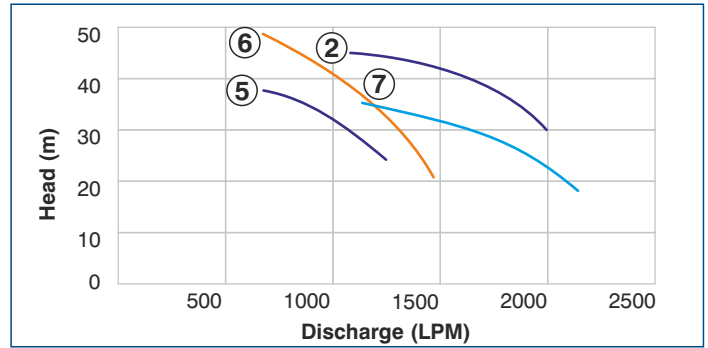
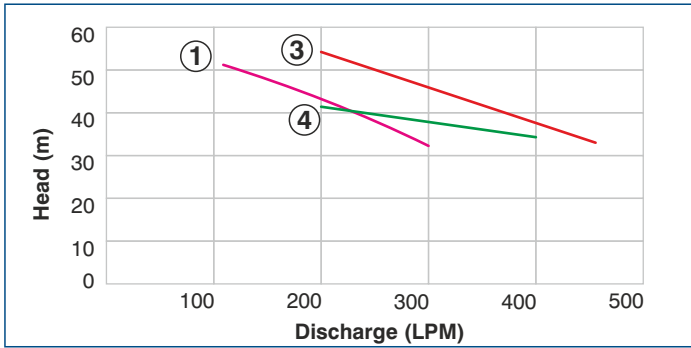

Performance Table: MB/MI Series

| Sr. No. | Rating | Motor | | Pipe Size mm | Head in Meter | | | | | |
|---------|------------|-------|------|--------------|------------------|------|------|--------|-----|--------|
| | | | | | 30 | 33 | 39 | 45 | 48 | 54 |
| | | kW | HP | | Discharge in LPM | | | | | |
| 1 | MIKS52-51 | 3.7 | 5.0 | 50X40 | - | 300 | 240 | 180 | 150 | 120@51 |
| 2 | MIR20.2-45 | 15.0 | 20.0 | 100X80 | 2000 | 1900 | 1600 | 1100 | - | - |
| 3 | MIK7.52-54 | 5.5 | 7.5 | 50X40 | - | 450 | 395 | 335 | 300 | 200 |
| 4 | MINS52-42 | 3.7 | 5.0 | 65X50 | - | 400 | 270 | 200@42 | - | - |

| Sr. No. | Rating | Motor | | Pipe Size mm | Head in Meter | | | | | | | | | |
|---------|------------|-------|------|--------------|------------------|------|------|------|------|------|---------|-----|-----|--|
| | | | | | 18 | 21 | 24 | 27 | 30 | 33 | 39 | 45 | 48 | |
| | | kW | HP | | Discharge in LPM | | | | | | | | | |
| 5 | MIP10.2-38 | 7.5 | 10.0 | 80X65 | - | - | 1250 | 1150 | 1050 | 950 | 700@38 | - | - | |
| 6 | MIP15.2-51 | 11.0 | 15.0 | 80X65 | - | 1480 | 1420 | 1350 | 1290 | 1220 | 1080 | 800 | 700 | |
| 7 | MIS15.2-36 | 11.0 | 15.0 | 100X100 | 2140 | 2000 | 1930 | 1800 | 1660 | 1445 | 1150@36 | - | - | |

| Sr. No. | Rating | Motor | | Pipe Size mm | Head in Meter | | | | | |
|---------|------------|-------|------|--------------|------------------|------|------|------|------|-----|
| | | | | | 15 | 18 | 21 | 24 | 27 | 30 |
| | | kW | HP | | Discharge in LPM | | | | | |
| 8 | MINH52-30 | 3.7 | 5.0 | 65X50 | 860 | 825 | 750 | 665 | 525 | 250 |
| 9 | MIP7.52-30 | 5.5 | 7.5 | 80X65 | - | - | 1080 | 970 | 900 | 825 |
| 10 | MIS10.2-30 | 7.5 | 10.0 | 100X100 | 1850 | 1720 | 1600 | 1450 | 1200 | 900 |

| Sr. No. | Rating | Motor | | Pipe Size mm | Head in Meter | | | |
|---------|----------|-------|-----|--------------|------------------|-----|-----|-----|
| | | | | | 18 | 21 | 24 | 27 |
| | | kW | HP | | Discharge in LPM | | | |
| 11 | MIP52-27 | 3.7 | 5.0 | 80X65 | 850 | 740 | 620 | 450 |

| Sr. No. | Rating | Motor | | Pipe Size mm | Head in Meter | | | | |
|---------|-----------|-------|-----|--------------|------------------|------|-----|-----|-----|
| | | | | | 21 | 24 | 27 | 30 | 33 |
| | | kW | HP | | Discharge in LPM | | | | |
| ★12 | MIP7.52FF | 5.5 | 7.5 | 80X65 | 1100 | 1060 | 980 | 900 | 650 |

Performance Curve: MB/MI Series

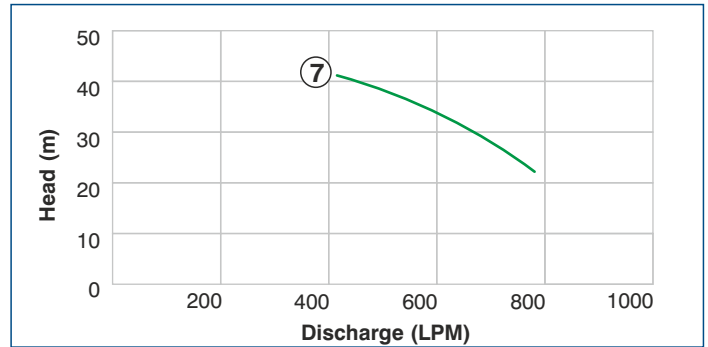
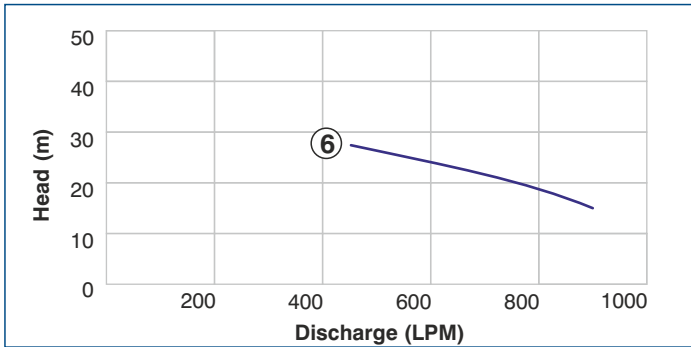
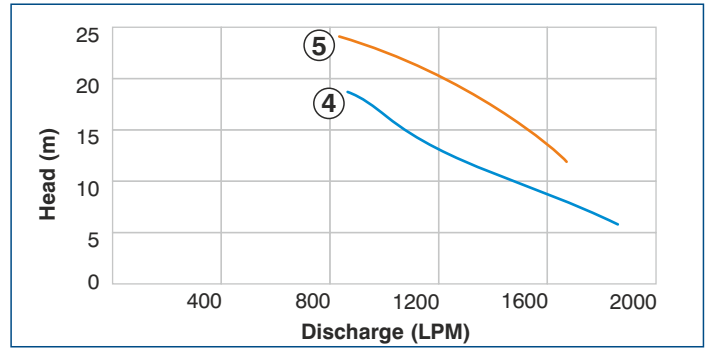
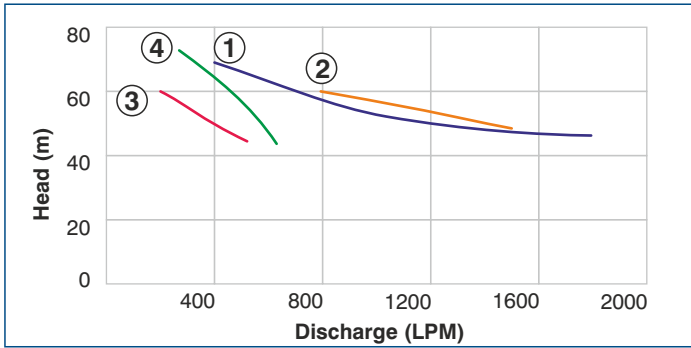

Performance Table: MB/MI Series

| Sr. No. | Rating | Motor | | Pipe Size mm | Head in Meter | | | |
|---------|-------------|-------|------|--------------|------------------|------|------|--------|
| | | kW | HP | | 45 | 48 | 54 | 60 |
| | | | | | Discharge in LPM | | | |
| 1 | MIR30.2-69 | 22.0 | 30.0 | 100X80 | - | 1800 | 1050 | 400@69 |
| 2 | MIR25.2-60 | 18.5 | 25.0 | 100X80 | - | 1500 | 1150 | 800 |
| 3 | MINH10.2-60 | 7.5 | 10.0 | 65X50 | 550 | 520 | 420 | 300 |

| Sr. No. | Rating | Motor | | Pipe Size mm | Head in Meter | | | | | |
|---------|------------|-------|-----|--------------|------------------|------|------|------|------|-----|
| | | kW | HP | | 6 | 12 | 15 | 18 | 21 | 24 |
| | | | | | Discharge in LPM | | | | | |
| 4 | MIS52-18 | 3.7 | 5.0 | 100X100 | 1850 | 1460 | 1040 | 900 | - | - |
| 5 | MIS7.52-24 | 5.5 | 7.0 | 100X100 | - | 1680 | 1540 | 1380 | 1170 | 840 |

| Sr. No. | Rating | Motor | | Pipe Size mm | Head in Meter | | | | | | | | | |
|---------|-------------|-------|-----|--------------|------------------|-----|-----|-----|-----|-----|-----|-----|-----|--|
| | | kW | HP | | 15 | 18 | 21 | 24 | 27 | 30 | 33 | 39 | 42 | |
| | | | | | Discharge in LPM | | | | | | | | | |
| 6 | MINH7.52-42 | 5.5 | 7.5 | 65X50 | - | - | 750 | 730 | 705 | 680 | 650 | 530 | 440 | |
| ★7 | MIP52FF | 3.7 | 5.0 | 80X65 | 900 | 820 | 720 | 600 | 450 | - | - | - | - | |

Performance Curve: MB/MI Series

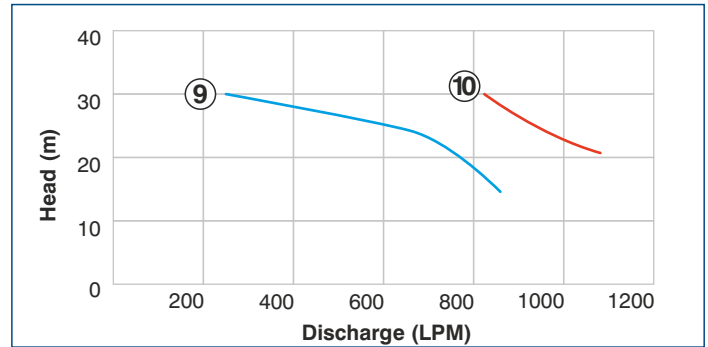
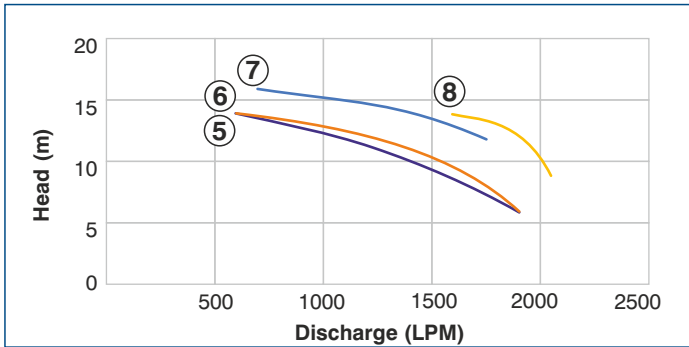
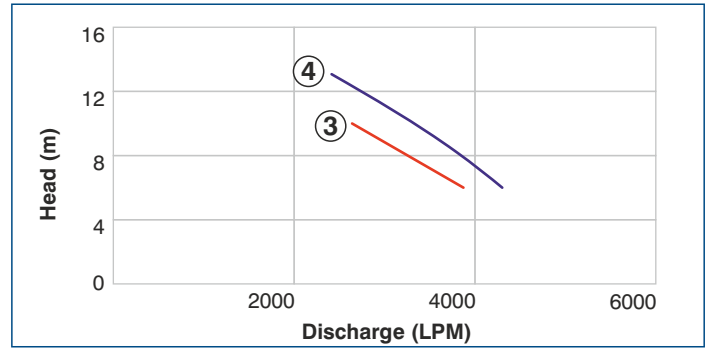
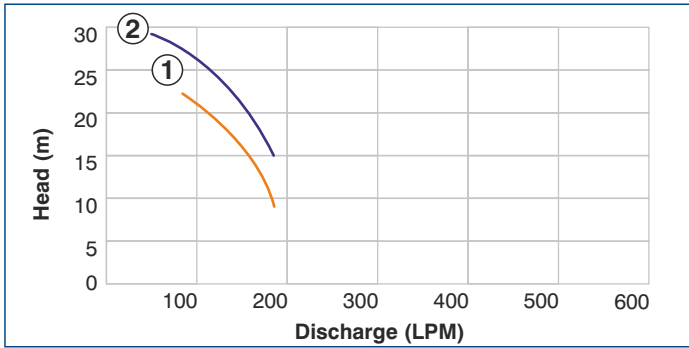

Performance Table: MB/MI Series

| Sr. No. | Rating | Motor | | Pipe Size mm | Head in Meter | | | | |
|---------|---------------|-------|-----|--------------|------------------|-----|-----|-----|----------|
| | | | | | 9 | 12 | 15 | 21 | 24 |
| | | | | | Discharge in LPM | | | | |
| 1 | MBG12(3PHASE) | 0.75 | 1.0 | 40X32 | 175 | 165 | 150 | 100 | 85@22.5m |

| Sr. No. | Rating | Motor | | Pipe Size mm | Head in Meter | | | |
|---------|---------|-------|-----|--------------|------------------|-----|-----|----------|
| | | | | | 15 | 21 | 24 | 30 |
| | | | | | Discharge in LPM | | | |
| 2 | MBG1.52 | 1.1 | 1.5 | 40X32 | 175 | 140 | 115 | 50@28.5m |

| Sr. No. | Rating | Motor | | Pipe Size mm | Head in Meter | | | |
|---------|--------|-------|------|--------------|------------------|------|----------|----------|
| | | | | | 6 | 9 | 12 | 15 |
| | | | | | Discharge in LPM | | | |
| #3 | MBW7.5 | 5.5 | 7.5 | 150X150 | 3810 | 2980 | 2630@10m | - |
| #4 | MBW10 | 7.5 | 10.0 | 150X150 | 4246 | 3550 | 2500 | 2020@13m |

| Sr. No. | Rating | Motor | | Pipe Size mm | Head in Meter | | | | | | | |
|---------|---------|-------|-----|--------------|------------------|------|------|------|------|------|------|-----|
| | | | | | 6 | 8 | 9 | 11 | 12 | 14 | 15 | 16 |
| | | | | | Discharge in LPM | | | | | | | |
| #5 | OMBR5 | 3.7 | 5.0 | 100X80 | 1900 | 1600 | 1550 | 1350 | 1000 | 600 | - | - |
| #6 | OMBS5 | 3.7 | 5.0 | 100X100 | 1900 | 1700 | 1600 | 1470 | 1150 | 600 | - | - |
| #7 | OMBR7.5 | 5.5 | 7.5 | 100X80 | - | - | - | - | 1750 | 1470 | 1085 | 700 |
| #8 | OMBS7.5 | 5.5 | 7.5 | 100X100 | - | - | 2050 | 2000 | 1980 | 1600 | - | - |

| Sr. No. | Rating | Motor | | Pipe Size mm | Head in Meter | | | |
|---------|-----------|-------|-----|--------------|------------------|------|-----|-----|
| | | | | | 15 | 21 | 24 | 30 |
| | | | | | Discharge in LPM | | | |
| 9 | MBNH52FS | 3.7 | 5.0 | 65X50 | 860 | 750 | 665 | 250 |
| 10 | MBP7.52FS | 5.5 | 7.5 | 80X65 | - | 1080 | 970 | 825 |

Note :

1. The motor ratings in HP are only indicative and for reference purpose
2. Performance figures given above are approximate and may differ on site conditions

3. Performance mentioned on nameplate may vary as we are always improving our products
4. * Models with a Gland packing construction.
5. # Models with 4 pole motor & Gland packing construction.

Material of Construction:

| No. | Part | Material |
|-----|-------------|------------------------|
| 1 | Impeller | Cast Iron-Grade FG 200 |
| 2 | Volute | Cast Iron-Grade FG 200 |
| 3 | Stamping | CRNGO-M47 |
| 4 | Motor Body | Cast Iron-Grade FG 200 |
| 5 | Flanges | Cast Iron-Grade FG 200 |
| 6 | Adapter | Cast Iron-Grade FG 200 |
| 7 | Motor Shaft | Carbon steel Gr C40 |
| 8 | Sealing | Mechanical seal |

Pump Dimensional Details:

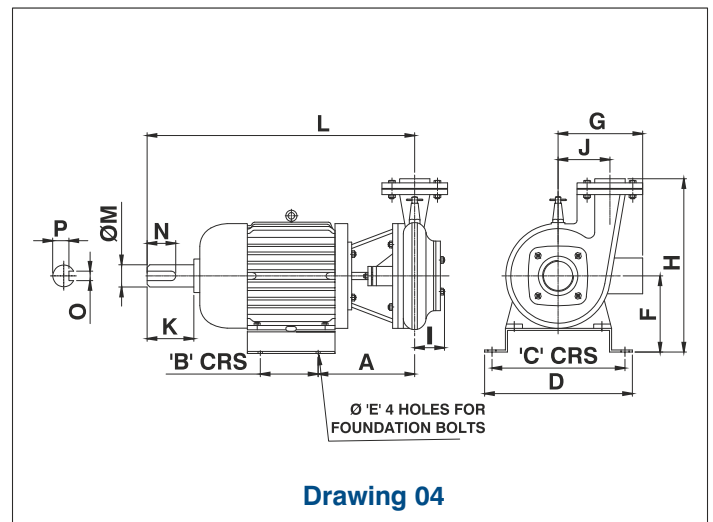
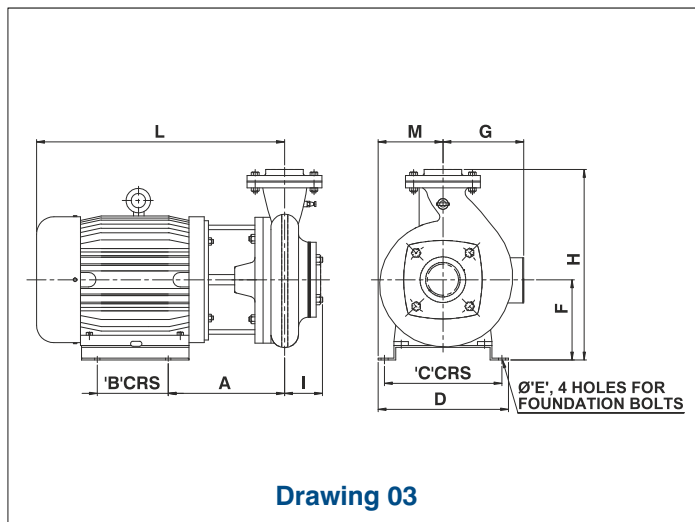
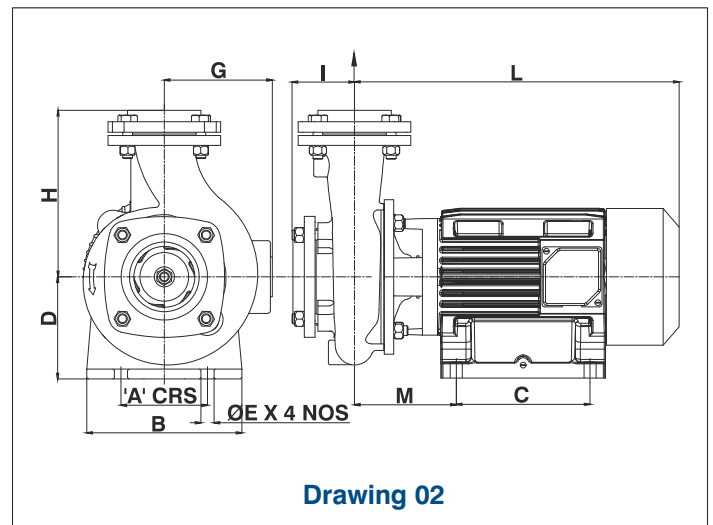
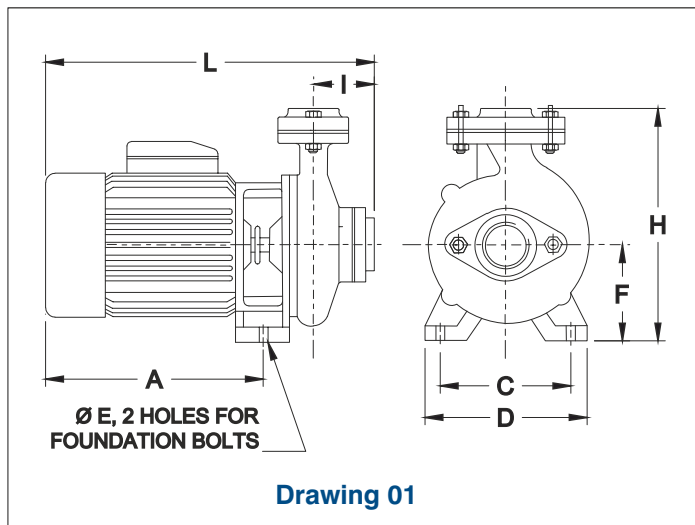

| Refer Drawing 01 | | | | | | | | | | | |
|-----------------------|--------------|--------------------------|-----|-----|----|-----|-----|-----|----|-----|-----|
| Model Name | Pipe Size mm | All Dimensions are in mm | | | | | | | | | |
| | | A | C | D | E | F | G | H | I | L | M |
| MBG12(3PHASE) | 40X32 | 230 | 110 | 150 | 9 | 100 | 75 | 265 | 72 | 370 | 265 |
| MBG1.52 | 40X32 | 265 | 110 | 150 | 9 | 100 | 75 | 265 | 68 | 400 | 265 |
| MIK22-18/MIK22(HT)-18 | 50X40 | 265 | 210 | 150 | 15 | 116 | 150 | 291 | 78 | 389 | 123 |
| MIKH22-27 | 50X40 | 265 | 210 | 150 | 15 | 116 | 150 | 293 | 78 | 389 | 123 |

| Refer Drawing 02 | | | | | | | | | | | |
|------------------|--------------|--------------------------|-----|-----|-----|----|-----|----|-----|-----|-----|
| Model Name | Pipe Size mm | All Dimensions are in mm | | | | | | | | | |
| | | A | B | C | D | E | H | I | L | M | G |
| MIN22-21 | 65X50 | 138 | 193 | 156 | 116 | 14 | 293 | 78 | 369 | 110 | 103 |
| MIK32-27 | 50X40 | 138 | 193 | 156 | 116 | 14 | 306 | 78 | 371 | 112 | 103 |
| MIN32-26 | 65X50 | 138 | 193 | 156 | 116 | 14 | 309 | 73 | 369 | 110 | 103 |
| MIKS32-36 | 50X40 | 138 | 193 | 156 | 116 | 14 | 316 | 78 | 371 | 112 | 103 |
| MIQ32-15 | 80X80 | 138 | 193 | 156 | 116 | 14 | 336 | 87 | 380 | 120 | 103 |
| MIP32-15 | 80X65 | 138 | 193 | 156 | 116 | 14 | 336 | 87 | 380 | 120 | 103 |

| Refer Drawing 03 | | | | | | | | | | | | |
|------------------|--------------|--------------------------|-----|-----|-----|----|-----|-----|-----|-----|-----|-----|
| Model Name | Pipe Size mm | All Dimensions are in mm | | | | | | | | | | |
| | | A | B | C | D | E | F | G | H | I | L | M |
| MIK52-39 | 50 x 40 | 169 | 110 | 270 | 310 | 19 | 138 | 170 | 338 | 74 | 434 | 155 |
| MIN7.52-36 | 65 x 50 | 177 | 130 | 305 | 345 | 19 | 164 | 190 | 369 | 80 | 494 | 173 |
| MIP7.52-30 | 80 x 65 | 176 | 130 | 305 | 345 | 19 | 164 | 190 | 356 | 77 | 493 | 173 |
| MIS7.52-24 | 100 x 100 | 185 | 130 | 305 | 345 | 19 | 164 | 190 | 394 | 85 | 501 | 173 |
| MINH10.2-60 | 65 x 50 | 180 | 130 | 305 | 345 | 19 | 164 | 190 | 414 | 73 | 530 | 173 |
| MIS15.2-36 | 100 x 100 | 182 | 130 | 305 | 345 | 19 | 164 | 190 | 409 | 86 | 533 | 173 |
| MIP15.2-51 | 80 x 65 | 180 | 130 | 305 | 345 | 19 | 164 | 190 | 414 | 82 | 530 | 173 |
| MIR15.2-39 | 100 x 80 | 180 | 130 | 305 | 345 | 19 | 164 | 190 | 434 | 82 | 530 | 173 |
| MIKS52-51 | 50 X 40 | 173 | 110 | 270 | 310 | 19 | 138 | 170 | 348 | 75 | 438 | 155 |
| MINS52-42 | 65 X 50 | 169 | 110 | 270 | 310 | 19 | 138 | 170 | 358 | 94 | 434 | 155 |
| MINH52-30 | 65 X 50 | 172 | 110 | 270 | 310 | 19 | 138 | 170 | 323 | 77 | 437 | 155 |
| MIP52-27 | 80 X 65 | 172 | 110 | 270 | 310 | 19 | 138 | 170 | 323 | 77 | 437 | 155 |
| MIQ52-21 | 80 X 80 | 185 | 110 | 270 | 310 | 19 | 138 | 170 | 368 | 87 | 450 | 155 |
| MIS52-18 | 100 X 100 | 185 | 110 | 270 | 310 | 19 | 138 | 170 | 368 | 87 | 450 | 155 |
| MIK7.52-54 | 50 X 40 | 174 | 130 | 305 | 345 | 19 | 164 | 190 | 379 | 70 | 490 | 173 |
| MINH7.52-42 | 65 X 50 | 177 | 130 | 305 | 345 | 19 | 164 | 190 | 379 | 80 | 494 | 173 |
| MIP10.2-38 | 80 X 65 | 180 | 130 | 305 | 345 | 19 | 164 | 190 | 414 | 82 | 530 | 173 |
| MIR10.2-33 | 100 X 80 | 182 | 130 | 305 | 345 | 19 | 164 | 190 | 434 | 82 | 535 | 173 |
| MIS10.2-30 | 100 X 100 | 182 | 130 | 305 | 345 | 19 | 164 | 190 | 409 | 86 | 533 | 173 |
| MIR20.2-45 | 100 X 80 | 235 | 210 | 254 | 300 | 19 | 180 | 198 | 450 | 82 | 649 | 175 |
| MIR25.2-60 | 100 X 80 | 253 | 210 | 254 | 300 | 19 | 180 | 198 | 470 | 90 | 667 | 225 |
| MIR30.2-69 | 100 X 80 | 253 | 210 | 254 | 300 | 19 | 180 | 198 | 470 | 90 | 667 | 225 |
| MBW7.5 | 150X150 | 264 | 130 | 305 | 345 | 19 | 202 | 190 | 552 | 110 | 545 | 173 |
| MBW10 | 150X150 | 264 | 130 | 305 | 345 | 19 | 202 | 190 | 552 | 110 | 579 | 173 |

| Refer Drawing 04 | | | | | | | | | | | | | | | | | |
|------------------|--------------|--------------------------|-----|-----|-----|----|-----|-----|-----|----|-----|----|-----|----|----|----|----|
| Model Name | Pipe Size mm | All Dimensions are in mm | | | | | | | | | | | | | | | |
| | | A | B | C | D | E | F | G | H | I | J | K | L | M | N | O | P |
| OMBR5 | 100X80 | 244 | 110 | 270 | 310 | 19 | 202 | 170 | 410 | 83 | 150 | 60 | 504 | 28 | 44 | 8 | 24 |
| OMBS5 | 100X100 | 244 | 110 | 270 | 310 | 19 | 202 | 170 | 410 | 83 | 150 | 60 | 504 | 28 | 44 | 8 | 24 |
| OMBR7.5 | 100X80 | 257 | 130 | 305 | 345 | 19 | 164 | 19 | 375 | 83 | 166 | 80 | 553 | 38 | 60 | 10 | 34 |
| OMBS7.5 | 100X100 | 257 | 130 | 305 | 345 | 19 | 164 | 19 | 375 | 83 | 166 | 80 | 553 | 38 | 60 | 10 | 34 |

| Refer Drawing 04 | | | | | | | | | | | | |
|------------------|--------------|--------------------------|-----|-----|-----|----|-----|-----|-----|----|-----|-----|
| Model Name | Pipe Size mm | All Dimensions are in mm | | | | | | | | | | |
| | | A | B | C | D | E | F | G | H | I | L | M |
| MBNH52FS | 65X50 | 219 | 110 | 270 | 310 | 19 | 138 | 170 | 348 | 75 | 469 | 155 |
| MBP7.52FS | 80X65 | 255 | 130 | 305 | 345 | 19 | 164 | 190 | 356 | 77 | 536 | 173 |

MBG Series Centrifugal Monoset Pumps



High Grade Electrical Stampings

Reduced Electrical losses lower the operating current of the pump



Dynamically Balanced Rotating Parts

Minimum vibrations protect components from damage during operation



Reliable Mechanical Seal

High quality and long life mechanical seal



Easy for Maintenance

Easily replaceable wear & tear Parts

Technical Specifications:

- Range: 0.5 HP to 3.0 HP (0.37kW to 2.2kW)
- Rated voltage: 220V for 1PH
- Voltage range: 160V - 240V
- Rated Frequency: 50Hz
- Pipe size: 25X25 to 100X100
- Max. Head: Upto 33 meter
- Max. Discharge: Upto 1080 LPM
- Liquid: Clear water

Applications

- Bungalows, Buildings, Flats
- Hotels, Garages, Laundries
- Small Farms & Lawn Sprinklers
- Cooling Tower
- Sprinkler Irrigation, Drip Irrigation, Lift irrigation
- Construction sites
- Office & Shopping Mall Cooling System



Performance Curve: MBG Series

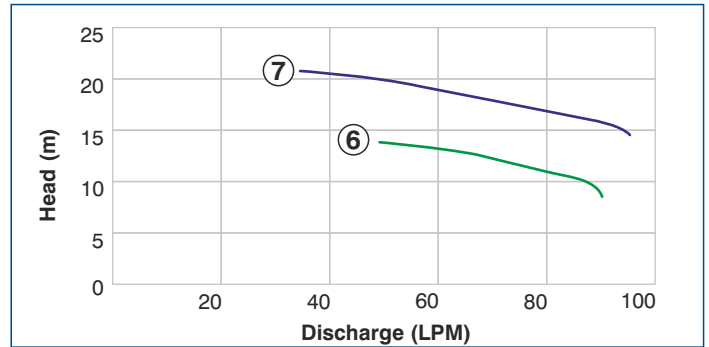
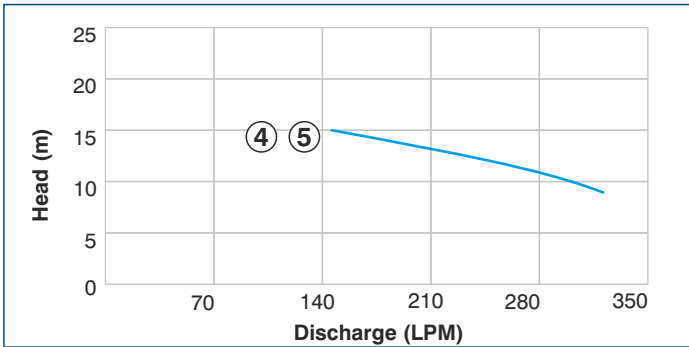
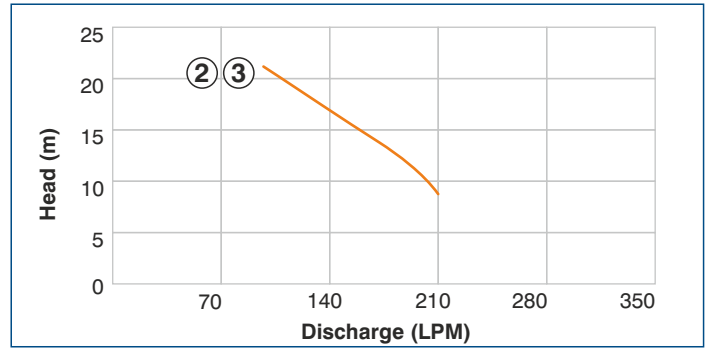
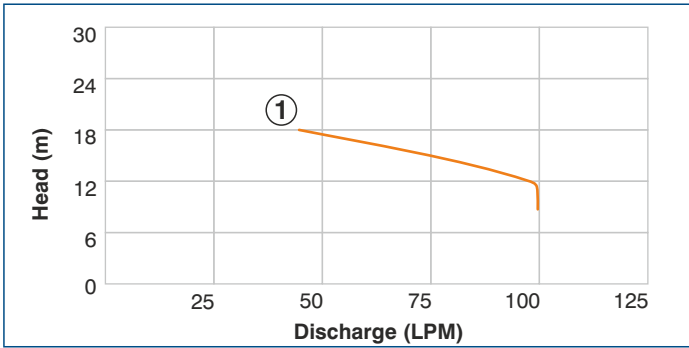

Performance Table: MBG Series

| Sr. No. | Rating | Motor | | Pipe Size mm | Head in Meter | | | | | | |
|---------|-----------------|-------|-----|--------------|---------------|-----|----|----|----|----|----|
| | | kW | HP | | 6 | 9 | 12 | 14 | 15 | 16 | 18 |
| 1 | MBD052(1PH)Y-18 | 0.37 | 0.5 | 25X25 | - | 100 | 98 | 80 | 75 | 65 | 45 |

| Sr. No. | Rating | Motor | | Pipe Size mm | Head in Meter | | | | |
|---------|---------------|-------|-----|--------------|---------------|-----|-----|-----|-----|
| | | kW | HP | | 9 | 12 | 15 | 18 | 21 |
| 2 | MBG12(1PH)-21 | 0.75 | 1.0 | 40X32 | 210 | 190 | 160 | 130 | 100 |
| 3 | MBJ12(1PH) | 0.75 | 1.0 | 40X40 | 210 | 190 | 160 | 130 | 100 |
| 4 | MBM12(1PH) | 0.75 | 1.0 | 50X50 | 320 | 250 | 150 | - | - |
| 5 | MBM12(1PH)LV | 0.75 | 1.0 | 50X50 | 320 | 250 | 150 | - | - |

| Sr. No. | Rating | Motor | | Pipe Size mm | Head in Meter | | | | | |
|---------|-----------------|-------|-----|--------------|---------------|----|----|----|----|----|
| | | kW | HP | | 9 | 10 | 11 | 12 | 13 | 14 |
| *6 | MAD052(1PH)Y-14 | 0.37 | 0.5 | 25X25 | 90 | 88 | 80 | 72 | 64 | 50 |

| Sr. No. | Rating | Motor | | Pipe Size mm | Head in Meter | | | | | |
|---------|-----------------|-------|-----|--------------|---------------|----|----|----|----|----|
| | | kW | HP | | 15 | 16 | 18 | 19 | 20 | 21 |
| *7 | MAD052(1PH)Y-21 | 0.37 | 0.5 | 25X25 | 95 | 90 | 70 | 60 | 50 | 35 |

Performance Curve: MBG Series

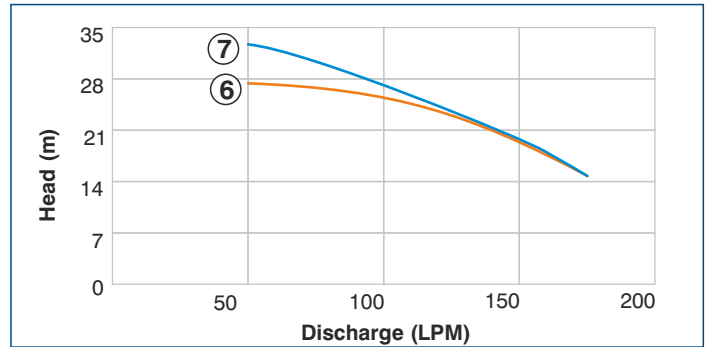
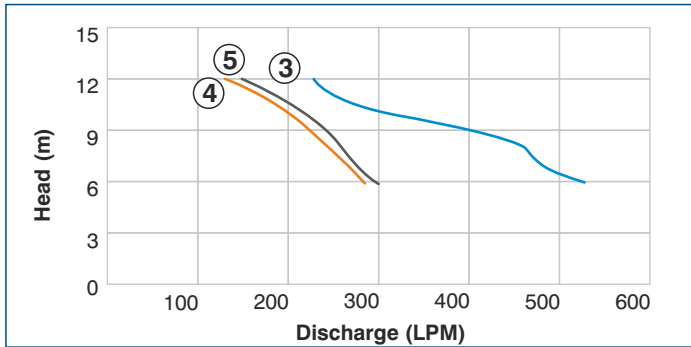
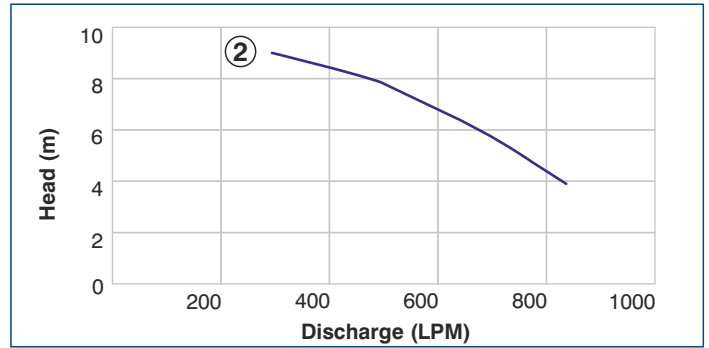
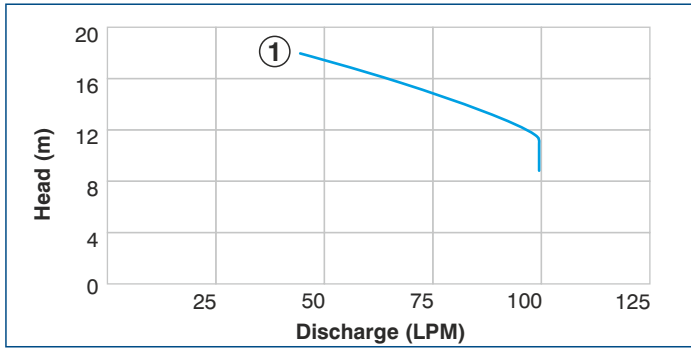

Performance Table: MBG Series

| Sr. No. | Rating | Motor | | Pipe Size mm | Head in Meter | | | | | |
|---------|-----------------|-------|-----|--------------|------------------|----|----|----|----|----|
| | | kW | HP | | 9 | 12 | 14 | 15 | 16 | 18 |
| | | | | | Discharge in LPM | | | | | |
| *1 | MAD052(1PH)Y-18 | 0.37 | 0.5 | 25X25 | 100 | 98 | 80 | 75 | 65 | 45 |

| Sr. No. | Rating | Motor | | Pipe Size mm | Head in Meter | | | | | |
|---------|---------------|-------|-----|--------------|------------------|-----|-----|-----|-----|-----|
| | | kW | HP | | 4 | 5 | 6 | 7 | 8 | 9 |
| | | | | | Discharge in LPM | | | | | |
| 2 | MAQ12(1PH)Z-9 | 0.75 | 1.0 | 80X80 | 830 | 760 | 680 | 580 | 480 | 300 |

| Sr. No. | Rating | Motor | | Pipe Size mm | Head in Meter | | | | | | |
|---------|-----------------|-------|-----|--------------|------------------|-----|-----|-----|-----|-----|-----|
| | | kW | HP | | 6 | 7 | 8 | 9 | 10 | 11 | 12 |
| | | | | | Discharge in LPM | | | | | | |
| 3 | MBM12(1PH)HT-15 | 0.75 | 1.0 | 50X50 | 525 | 480 | 460 | 400 | 310 | 250 | 230 |
| 4 | MBJ052(1PH)Y-12 | 0.37 | 0.5 | 40X40 | 285 | 265 | 245 | 225 | 200 | 175 | 135 |
| 5 | MBM052(1PH)Y-12 | 0.37 | 0.5 | 50X50 | 295 | 275 | 260 | 240 | 220 | 190 | 150 |

| Sr. No. | Rating | Motor | | Pipe Size mm | Head in Meter | | | | |
|---------|-----------------|-------|-----|--------------|------------------|-----|-----|----|----|
| | | kW | HP | | 15 | 21 | 27 | 30 | 33 |
| | | | | | Discharge in LPM | | | | |
| 6 | MBG1.52(1PH)-27 | 1.1 | 1.5 | 40X32 | 175 | 140 | 50 | - | - |
| 7 | MBKS1.52(1PH) | 1.1 | 1.5 | 50X40 | 175 | 140 | 110 | 80 | 50 |

Performance Curve: MBG Series

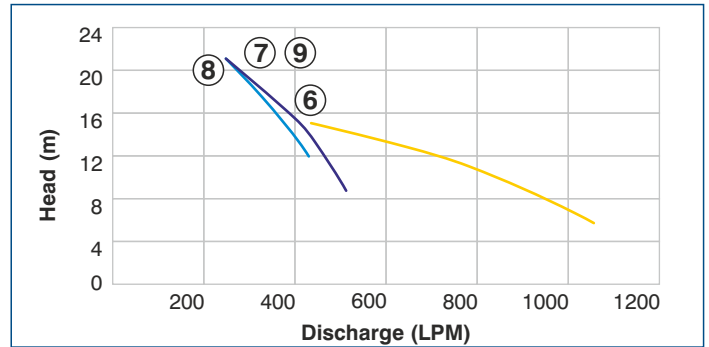
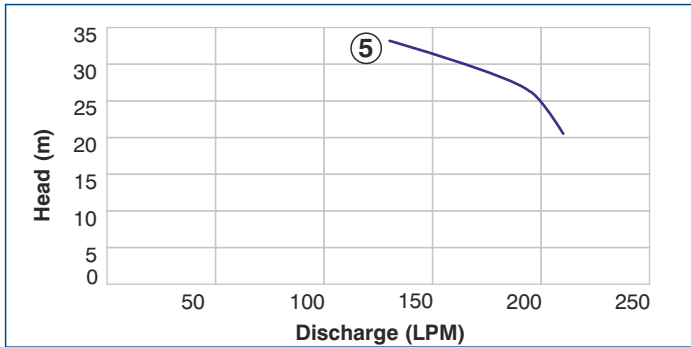
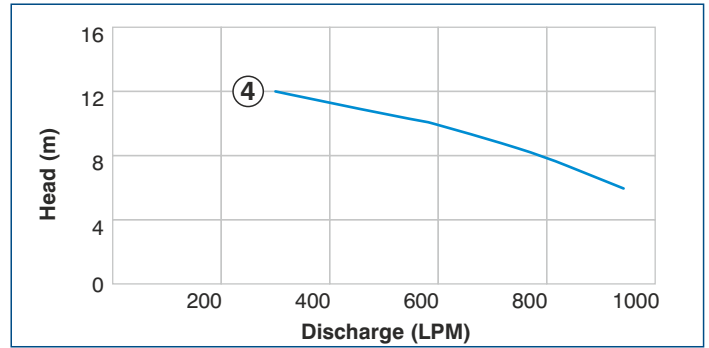
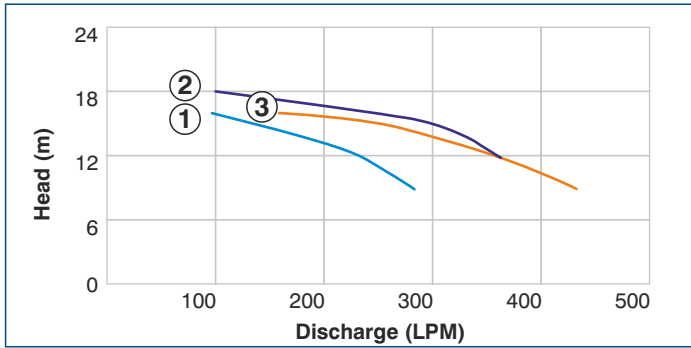

Performance Table: MBG Series

| Sr. No. | Rating | Motor | | Pipe Size mm | Head in Meter | | | |
|---------|---------------|-------|-----|--------------|------------------|-----|-----|----|
| | | kW | HP | | 9 | 12 | 14 | 16 |
| | | | | | Discharge in LPM | | | |
| 1 | MBK12(1PH)-16 | 0.75 | 1.0 | 50X40 | 280 | 230 | 170 | 95 |

| Sr. No. | Rating | Motor | | Pipe Size mm | Head in Meter | | | |
|---------|---------------|-------|-----|--------------|------------------|-----|-----|---------|
| | | kW | HP | | 9 | 12 | 15 | 21 |
| | | | | | Discharge in LPM | | | |
| 2 | MBKH1.52(1PH) | 1.1 | 1.5 | 50X40 | - | 360 | 300 | 100@18m |
| 3 | MBM1.52C | 1.1 | 1.5 | 50X50 | 430 | 355 | 250 | 160@16m |

| Sr. No. | Rating | Motor | | Pipe Size mm | Head in Meter | | | | |
|---------|-----------------|-------|-----|--------------|------------------|-----|-----|-----|-----|
| | | kW | HP | | 6 | 8 | 10 | 11 | 12 |
| | | | | | Discharge in LPM | | | | |
| 4 | MBQ1.52(1PH)-12 | 1.1 | 1.5 | 80X80 | 940 | 790 | 590 | 440 | 300 |

| Sr. No. | Rating | Motor | | Pipe Size mm | Head in Meter | | |
|---------|---------------|-------|-----|--------------|------------------|-----|-----|
| | | kW | HP | | 21 | 27 | 33 |
| | | | | | Discharge in LPM | | |
| 5 | MBJ22(1PH)-33 | 1.5 | 2.0 | 40X40 | 210 | 190 | 130 |

| Sr. No. | Rating | Motor | | Pipe Size mm | Head in Meter | | | | |
|---------|---------------|-------|-----|--------------|------------------|-----|-----|-----|-----|
| | | kW | HP | | 6 | 9 | 12 | 15 | 21 |
| | | | | | Discharge in LPM | | | | |
| 6 | MBQ32(1PH)-15 | 2.2 | 3.0 | 80X80 | 1050 | 900 | 720 | 440 | - |
| 7 | MBN22(l)-21 | 1.5 | 2.0 | 65X50 | - | 510 | 465 | 410 | 250 |
| 8 | MBM22(1PH)-21 | 1.5 | 2.0 | 50X50 | - | - | 430 | 380 | 250 |
| 9 | MBN22(1PH)-21 | 1.5 | 2.0 | 65X50 | - | 510 | 465 | 410 | 250 |

Performance Curve: MBG Series

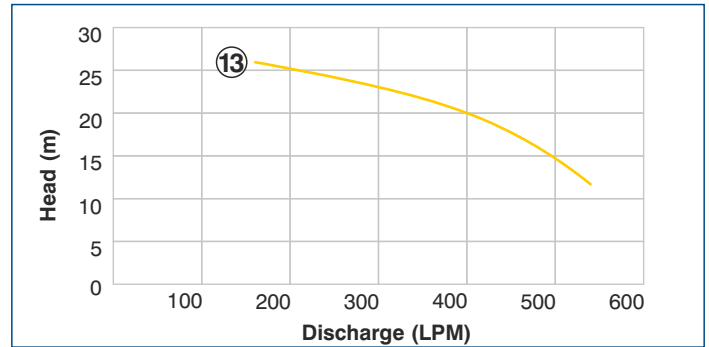
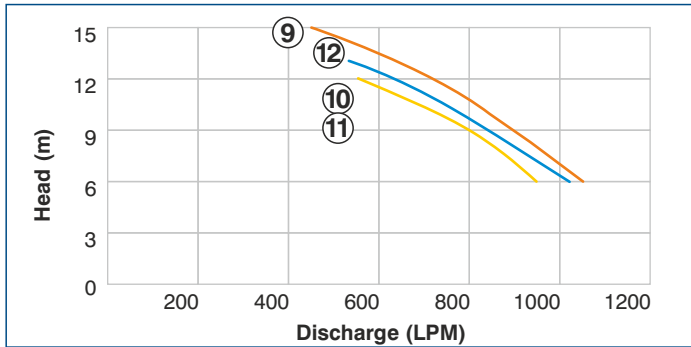
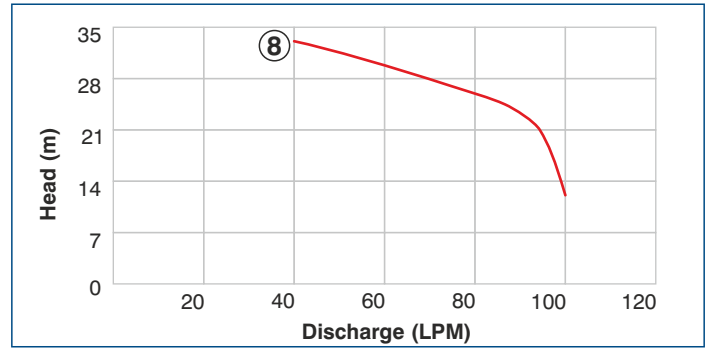
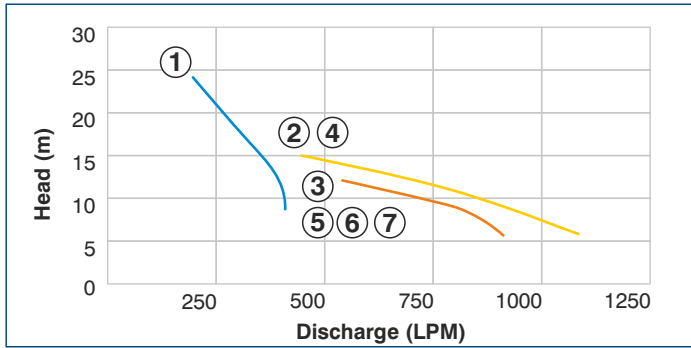

Performance Table: MBG Series

| Sr. No. | Rating | Motor | | Pipe Size mm | Head in Meter | | | | | |
|---------|-----------------|-------|-----|--------------|------------------|-----|-----|-----|-----|-----|
| | | kW | HP | | 6 | 9 | 12 | 15 | 21 | 24 |
| | | | | | Discharge in LPM | | | | | |
| 1 | MBK22(1PH)-24 | 1.5 | 2.0 | 50X40 | - | 410 | 395 | 335 | 250 | 200 |
| 2 | MBS32(I)-15 | 2.2 | 3.0 | 100X100 | 1080 | 920 | 720 | 450 | - | - |
| 3 | MBQ22(I) | 1.5 | 2.0 | 80X80 | 910 | 800 | 550 | - | - | - |
| 4 | MBS32(1PH)-15 | 2.2 | 3.0 | 100X100 | 1080 | 920 | 720 | 450 | - | - |
| 5 | MBQ22(1PH)-12 | 1.5 | 2.0 | 80X80 | 910 | 800 | 550 | - | - | - |
| 6 | MBQ22(I)-SE | 1.5 | 2.0 | 80X80 | 910 | 800 | 550 | - | - | - |
| 7 | MBQ22(1PH)LV-12 | 1.5 | 2.0 | 80X80 | 910 | 800 | 550 | - | - | - |

| Sr. No. | Rating | Motor | | Pipe Size mm | Head in Meter | | | | | | | |
|---------|---------------|-------|-----|--------------|------------------|----|----|----|----|----|----|----|
| | | kW | HP | | 12 | 15 | 18 | 21 | 24 | 27 | 30 | 33 |
| | | | | | Discharge in LPM | | | | | | | |
| * 8 | MAD12(1PH)-33 | 0.75 | 1.0 | 25X25 | 100 | 98 | 96 | 94 | 88 | 75 | 60 | 40 |

| Sr. No. | Rating | Motor | | Pipe Size mm | Head in Meter | | | | |
|---------|---------------|-------|-----|--------------|------------------|-----|-----|-----|-----|
| | | kW | HP | | 6 | 9 | 12 | 13 | 15 |
| | | | | | Discharge in LPM | | | | |
| 9 | MBQ32(I)-15 | 2.2 | 3.0 | 80X80 | 1050 | 900 | 720 | 640 | 450 |
| 10 | MBS22(I)-12 | 1.5 | 2.0 | 100X100 | 950 | 805 | 555 | - | - |
| 11 | MBS22(1PH)-12 | 1.5 | 2.0 | 100X100 | 950 | 805 | 555 | - | - |
| 12 | MBQ22(1PH)-13 | 1.5 | 2.0 | 80X80 | 1020 | 845 | 640 | 540 | - |

| Sr. No. | Rating | Motor | | Pipe Size mm | Head in Meter | | | |
|---------|---------------|-------|-----|--------------|------------------|-----|-----|-----|
| | | kW | HP | | 12 | 15 | 21 | 26 |
| | | | | | Discharge in LPM | | | |
| 13 | MBN32(1PH)-26 | 2.2 | 3.0 | 65X50 | 540 | 500 | 380 | 165 |

Performance Curve: MBG Series

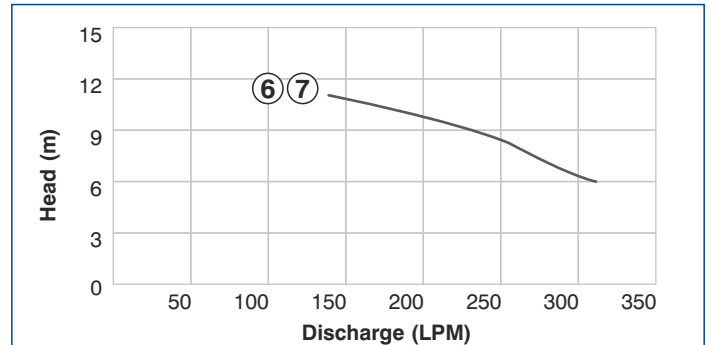
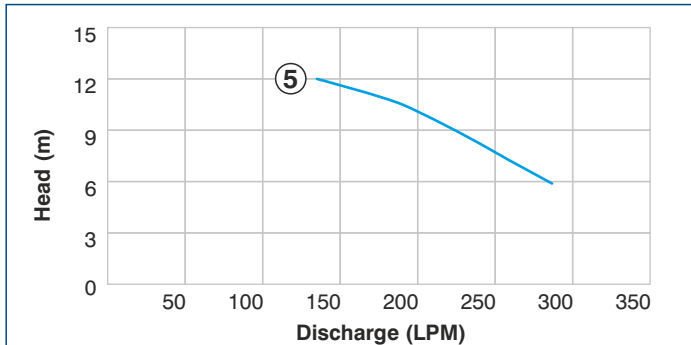
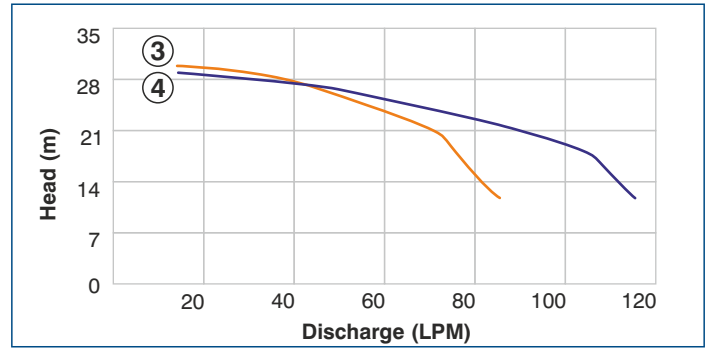
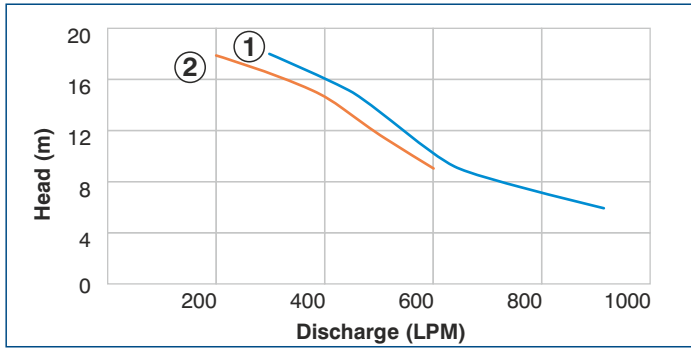

Performance Table: MBG Series

| Sr. No. | Rating | Motor | | Pipe Size mm | Head in Meter | | | | |
|---------|---------------|-------|-----|--------------|------------------|-----|-----|-----|-----|
| | | | | | 6 | 9 | 12 | 15 | 18 |
| | | kW | HP | | Discharge in LPM | | | | |
| 1 | MBP22(I)-18 | 1.5 | 2.0 | 80X65 | 910 | 650 | 550 | 450 | 300 |
| 2 | MBP22(1PH)-18 | 1.5 | 2.0 | 80X65 | - | 600 | 490 | 385 | 200 |

| Sr. No. | Rating | Motor | | Pipe Size mm | Head in Meter | | | | | | | |
|---------|----------------|-------|-----|--------------|------------------|----|----|----|----|----|----|----|
| | | | | | 12 | 14 | 15 | 17 | 19 | 21 | 28 | 30 |
| | | kW | HP | | Discharge in LPM | | | | | | | |
| *3 | MAD12(1PH)Y-30 | 0.75 | 1.0 | 25X25 | 85 | 81 | 80 | 77 | 74 | 71 | 38 | 15 |

| Sr. No. | Rating | Motor | | Pipe Size mm | Head in Meter | | | | | | |
|---------|----------------|-------|-----|--------------|------------------|-----|-----|----|----|----|----|
| | | | | | 12 | 15 | 18 | 21 | 24 | 27 | 29 |
| | | kW | HP | | Discharge in LPM | | | | | | |
| *4 | MAE12(1PH)Y-29 | 0.75 | 1.0 | 32X25 | 115 | 110 | 105 | 90 | 70 | 45 | 15 |

| Sr. No. | Rating | Motor | | Pipe Size mm | Head in Meter | | | | | | |
|---------|-------------------|-------|-----|--------------|------------------|-----|-----|-----|-----|-----|-----|
| | | | | | 6 | 7 | 8 | 9 | 10 | 11 | 12 |
| | | kW | HP | | Discharge in LPM | | | | | | |
| 5 | MAJ052(1PH)LVJ12 | 0.37 | 0.5 | 40X40 | 285 | 265 | 245 | 225 | 200 | 175 | 135 |
| 6 | MBJ052(1PH)Z-11SE | 0.37 | 0.5 | 40X40 | 310 | 280 | 260 | 230 | 190 | 140 | - |
| 7 | MBM052(1PH)Z-11SE | 0.37 | 0.5 | 50X50 | 310 | 280 | 260 | 230 | 190 | 140 | - |

Note :

1. The motor ratings in HP are only indicative and for reference purpose
2. Performance figures given above are approximate and may differ on site conditions

3. * Marked ratings are with Noryl impeller
4. Performance mentioned on nameplate may vary as we are always improving our products
5. The performance declaration of ISI pumps may vary with respect to this catalogue.

Material of Construction:

| Sr. No. | Part | Material |
|---------|-------------|------------------------------------|
| 1 | Impeller | Cast Iron-Grade FG 200/ Noryl |
| 2 | Volute | Cast Iron-Grade FG 200 |
| 3 | Stamping | CRNGO-M47 |
| 4 | Motor Body | Cast Iron-Grade FG 200 / Aluminium |
| 5 | Flanges | Cast Iron-Grade FG 200 |
| 6 | Adapter | Cast Iron-Grade FG 200 |
| 7 | Motor Shaft | Mild Steel- EN8 |
| 8 | Sealing | Mechanical seal |

Pump Dimensional Details:

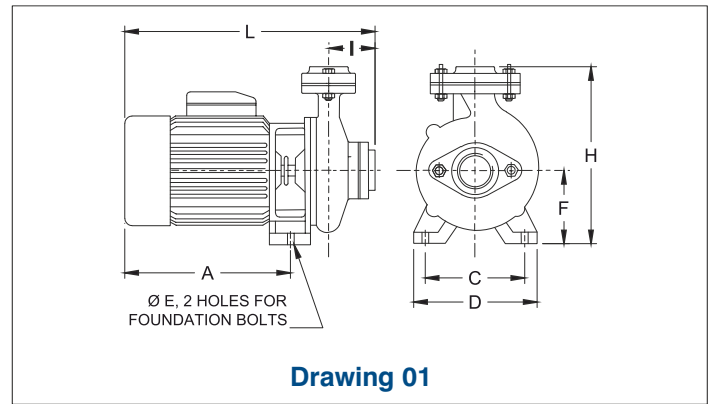

Pump Dimensional Details:

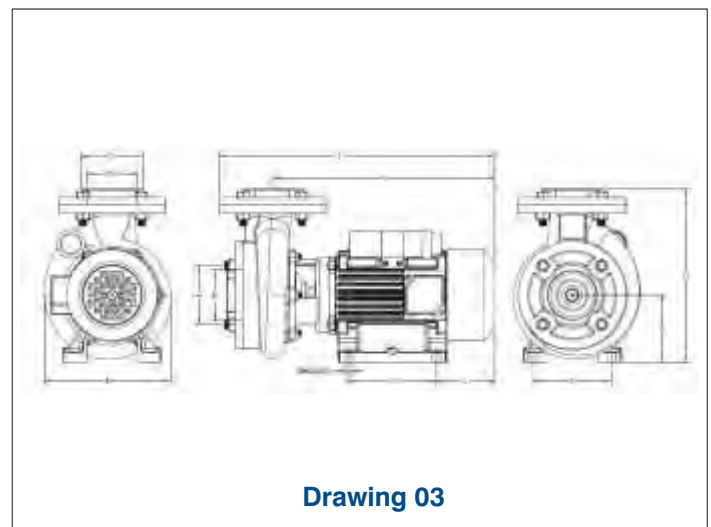
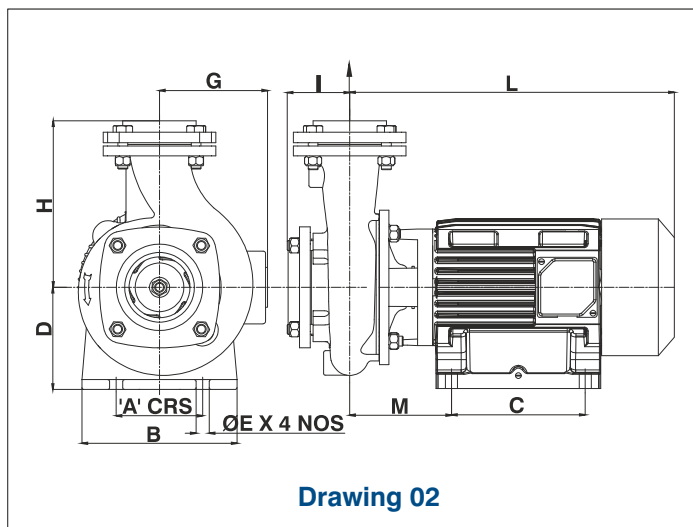

Refer Drawing 01

| Model Name | Pipe Size mm | All Dimensions are in mm | | | | | | | |
|------------------|-----------------|--------------------------|-----|-----|----|-----|-----|----|-----|
| | | A | C | D | E | F | H | I | L |
| MBG12(1PH)-21 | 40X32 | 230 | 110 | 150 | 9 | 100 | 265 | 72 | 370 |
| MBJ12(1PH) | 40X40 | 230 | 110 | 150 | 9 | 100 | 265 | 72 | 370 |
| MBM12(1PH) | 50X50 | 230 | 110 | 150 | 9 | 100 | 265 | 72 | 370 |
| MBK12(1PH)-16 | 50X40 | 230 | 110 | 150 | 9 | 100 | 265 | 72 | 370 |
| MBM12(1PH)LV | 50X50 | 230 | 110 | 150 | 9 | 100 | 265 | 72 | 370 |
| MBM12(1PH)HT-15 | 50X50 | 230 | 110 | 150 | 9 | 100 | 265 | 72 | 370 |
| MBG1.52(1PH)-27 | 40X32 | 265 | 110 | 150 | 9 | 100 | 326 | 68 | 400 |
| MBKH1.52(1PH) | 50X40 | 265 | 110 | 150 | 9 | 100 | 326 | 70 | 400 |
| MBKS1.52(1PH) | 50X40 | 265 | 110 | 150 | 9 | 100 | 328 | 68 | 400 |
| MBM1.52C | 50X50 | 265 | 110 | 150 | 9 | 100 | 328 | 72 | 400 |
| MBQ1.52(1PH)-12 | 80X80 | 265 | 110 | 150 | 9 | 126 | 336 | 87 | 400 |
| MAD12(1PH)-33 | 25X25 | 255 | 140 | 174 | 10 | 100 | 198 | 56 | 352 |
| MBK22(1PH)-24 | 50X40 | 265 | 110 | 150 | 15 | 100 | 328 | 72 | 400 |
| MAD12(1PH)Y-30 | 25X25 | 320 | 120 | 158 | 12 | 100 | 252 | 55 | 348 |
| MAE12(1PH)Y-29 | 32X25 | 320 | 120 | 158 | 12 | 100 | 252 | 55 | 348 |
| MAQ12(1PH)Z-9 | 80X80 | 281 | 140 | 180 | 12 | 110 | 295 | 77 | 406 |
| MAJ052(1PH)LVJ12 | 40X40 | 282 | 110 | 156 | 11 | 101 | 253 | 58 | 340 |

| Refer Drawing 02 | | | | | | | | | | | |
|------------------|-----------------|--------------------------|-----|-----|-----|----|-----|----|-----|-----|-----|
| Model Name | Pipe Size mm | All Dimensions are in mm | | | | | | | | | |
| | | A | B | C | D | E | H | I | L | M | G |
| MBJ22(1PH)-33 | 40X40 | 138 | 193 | 156 | 116 | 14 | 180 | 78 | 368 | 112 | 103 |
| MBM22(1PH)-21 | 50X50 | 138 | 193 | 156 | 116 | 14 | 180 | 78 | 368 | 112 | 103 |
| MBN22(1PH)-21 | 65X50 | 138 | 193 | 156 | 116 | 14 | 180 | 78 | 366 | 112 | 103 |
| MBN22(I)-21 | 65X50 | 138 | 193 | 156 | 116 | 14 | 180 | 78 | 366 | 112 | 103 |
| MBP22(1PH)-18 | 80X65 | 138 | 193 | 156 | 116 | 14 | 175 | 71 | 368 | 112 | 103 |
| MBP22(1PH)-12 | 80X65 | 138 | 193 | 156 | 116 | 14 | 175 | 71 | 368 | 112 | 103 |
| MBP22(1PH)-12 | 80X65 | 138 | 193 | 156 | 116 | 14 | 175 | 71 | 368 | 112 | 103 |
| MBP22(I)-18 | 80X65 | 138 | 193 | 156 | 116 | 14 | 175 | 71 | 368 | 112 | 103 |
| MBQ22(1PH)-12 | 80X80 | 138 | 193 | 156 | 116 | 14 | 195 | 87 | 376 | 120 | 103 |
| MBQ22(1PH)LV-12 | 80X80 | 138 | 193 | 156 | 116 | 14 | 195 | 87 | 376 | 120 | 103 |
| MBQ22(1PH)-13 | 80X80 | 138 | 193 | 156 | 116 | 14 | 195 | 87 | 376 | 120 | 103 |
| MBQ22(I) | 80X80 | 138 | 193 | 156 | 116 | 14 | 195 | 87 | 376 | 120 | 103 |
| MBQ22(I)-SE | 80X80 | 138 | 193 | 156 | 116 | 14 | 195 | 87 | 376 | 120 | 103 |
| MBS22(1PH)-12 | 100X100 | 138 | 193 | 156 | 116 | 14 | 195 | 87 | 376 | 120 | 103 |
| MBS22(1PH)LV-12 | 100X100 | 138 | 193 | 156 | 116 | 14 | 195 | 87 | 376 | 120 | 103 |
| MBS22(I)-12 | 100X100 | 138 | 193 | 156 | 116 | 14 | 195 | 87 | 376 | 120 | 103 |
| MBN32(1PH)-26 | 65X50 | 138 | 193 | 156 | 116 | 14 | 180 | 78 | 366 | 112 | 103 |
| MBQ32(1PH)-15 | 80X80 | 138 | 193 | 156 | 116 | 14 | 195 | 87 | 376 | 120 | 103 |
| MBQ32(I)-15 | 80X80 | 138 | 193 | 156 | 116 | 14 | 195 | 87 | 376 | 120 | 103 |
| MBS32(I)-15 | 100X100 | 138 | 193 | 156 | 116 | 14 | 200 | 87 | 376 | 120 | 103 |
| MBS32(1PH)-15 | 100X100 | 138 | 193 | 156 | 116 | 14 | 200 | 87 | 376 | 120 | 103 |
| MAD052(1PH)Y-14 | 25x25 | 105 | 128 | 60 | 78 | 9 | 174 | 55 | 235 | 95 | 81 |
| MAD052(1PH)Y-18 | 25x25 | 105 | 128 | 75 | 78 | 9 | 174 | 55 | 251 | 101 | 81 |
| MBD05(1PH)Y-18 | 25x25 | 104 | 129 | 80 | 78 | 9 | 148 | 55 | 251 | 91 | 82 |
| MAD052(1PH)Y-21 | 25x25 | 105 | 128 | 60 | 78 | 9 | 174 | 55 | 235 | 95 | 81 |
| MBJ052(1PH)Y-12 | 40x40 | 104 | 129 | 80 | 74 | 9 | 145 | 82 | 268 | 112 | 84 |
| MBM052(1PH)Y-12 | 50x50 | 104 | 129 | 80 | 74 | 9 | 145 | 82 | 268 | 112 | 84 |

| Refer Drawing 03 | | | | | | | | | | | | | | | |
|-------------------|-----------------|--------------------------|-----|-----|----|----|----|----|-----|----|----|-----|----|----|----|
| Model Name | Pipe Size mm | All Dimensions are in mm | | | | | | | | | | | | | |
| | | A | B | C | D | E | F | G | H | I | J | K | L | M | N |
| MBJ052(1PH)Z-11SE | 40X40 | 383 | 146 | 214 | 62 | 62 | 40 | 40 | 271 | 71 | 82 | 108 | 83 | 11 | 45 |
| MBM052(1PH)Z-11SE | 50X50 | 383 | 146 | 214 | 72 | 72 | 50 | 50 | 271 | 71 | 82 | 108 | 83 | 11 | 45 |

Openwell Submersible Pumps - Ultima Series



Less Power Consumption

High operating efficiency results in high flow rate and low electricity bill



Wide Voltage Application

Designed to withstand wide voltage fluctuations from 250V-440V & Provides Consistent Performance



Anti-Rust CED Coating

Offers rust Free & stuck free Operation



Effective Sealing

Motor is sealed effectively using high quality Mechanical seal which ensures adequate water for motor cooling



High Grade Electrical Stamping

Reduces electrical losses & improves pump efficiency



Easy for Maintenance

Simple construction, easily replaceable wear & tear parts

Technical Specifications:

- Range: 3HP to 7.5HP (2.2kW to 5.5kW)
- Voltage range: 250-440V
- Rated Frequency: 50Hz
- Delivery pipe Size: 40 mm to 100 mm
- Max. head: Upto 57 Meters
- Max. Discharge: Upto 2000 LPM
- Liquid: Clear Water
- Rotation: Clockwise as viewed from Motor end
- Connection: Star
- Motor Type : Water filled Motor

Applications:

- Agricultural farms
- Sprinkler irrigation
- Drinking water Supplies
- Water supply for industrial
- Drip irrigation
- Gardening



Performance Curve:

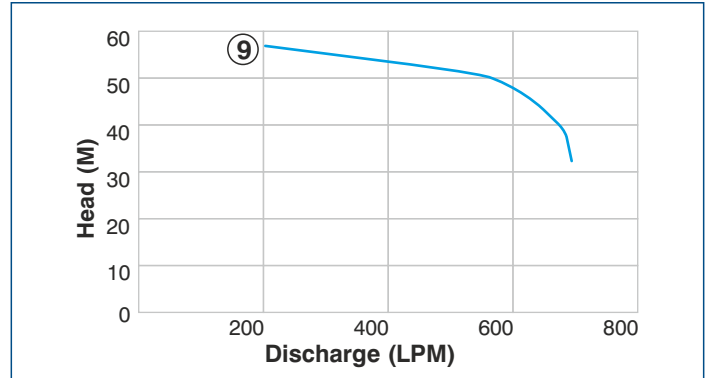
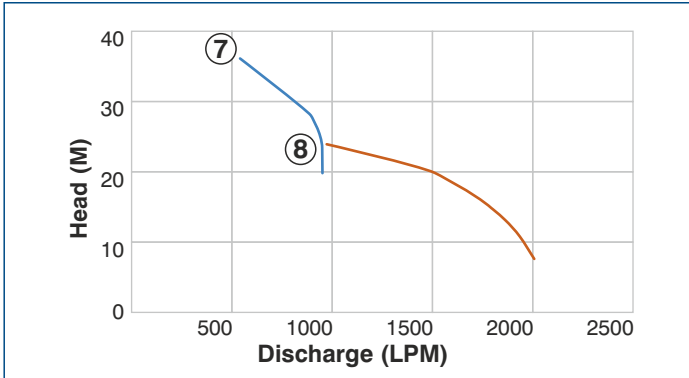
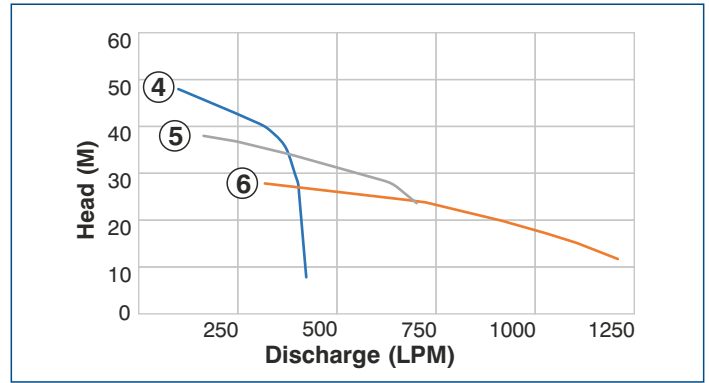
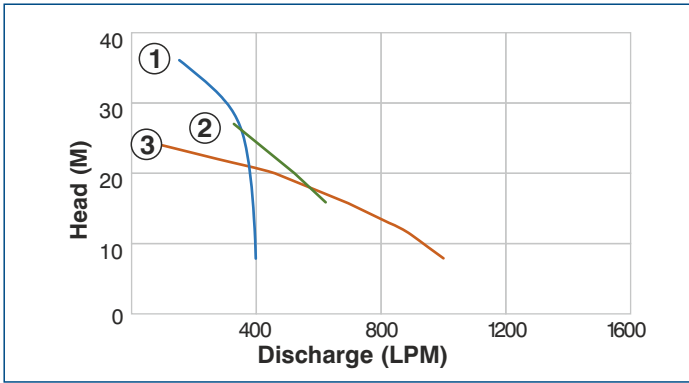

Performance Table:

| Sr. No. | Rating | Motor | | Outlet Size (mm) | Head in Meter | | | | | | | |
|---------|-------------|-------|----|------------------|------------------|-----|-----|-----|-----|---------|-----|-----|
| | | kW | HP | | 8 | 12 | 16 | 20 | 24 | 28 | 32 | 36 |
| | | | | | Discharge in LPM | | | | | | | |
| 1 | OWKS32G-36U | 2.2 | 3 | 40 | 400 | 395 | 390 | 380 | 365 | 340 | 270 | 155 |
| 2 | OWNH32G-27U | 2.2 | 3 | 50 | - | - | 620 | 520 | 410 | 330@27M | | - |
| 3 | OWO32G-23U | 2.2 | 3 | 65 | 1000 | 875 | 690 | 460 | 100 | - | - | - |

| Sr. No. | Rating | Motor | | Outlet Size (mm) | Head in Meter | | | | | | | | |
|---------|-------------|-------|----|------------------|------------------|------|------|-----|-----|-----|-----|---------|-----|
| | | kW | HP | | 8 | 12 | 16 | 20 | 24 | 28 | 36 | 40 | 48 |
| | | | | | Discharge in LPM | | | | | | | | |
| 4 | OWKS52G-48U | 3.7 | 5 | 40 | 460 | 455 | 450 | 445 | 440 | 435 | 400 | 350 | 100 |
| 5 | OWN52G-38U | 3.7 | 5 | 50 | - | - | - | - | 700 | 640 | 310 | 170@38M | |
| 6 | OWP52G-28U | 3.7 | 5 | 65 | - | 1230 | 1100 | 925 | 725 | 310 | - | - | - |

| Sr. No. | Rating | Motor | | Outlet Size (mm) | Head in Meter | | | | | | | |
|---------|--------------|-------|-----|------------------|------------------|------|------|------|-----|-----|-----|----|
| | | kW | HP | | 8 | 12 | 16 | 20 | 24 | 28 | 36 | 40 |
| | | | | | Discharge in LPM | | | | | | | |
| 7 | OWP7.52G-36U | 5.5 | 7.5 | 65 | - | - | - | 950 | 950 | 900 | 550 | - |
| 8 | OWS7.52G-25U | 5.5 | 7.5 | 100 | 2000 | 1900 | 1750 | 1500 | 980 | - | - | - |

| Sr. No. | Rating | Motor | | Outlet Size (mm) | Head in Meter | | | | | | | | |
|---------|---------------|-------|-----|------------------|------------------|-----|-----|-----|-----|-----|-----|-----|-----|
| | | kW | HP | | 33 | 36 | 39 | 42 | 45 | 48 | 51 | 54 | 57 |
| | | | | | Discharge in LPM | | | | | | | | |
| 9 | OWNS7.52G-57U | 5.5 | 7.5 | 50 | 630 | 625 | 620 | 600 | 580 | 550 | 500 | 350 | 200 |

Note :

1. The motor ratings in HP are only indicative and for reference purpose
2. Performance figures given above are approximate and may differ on site conditions

3. Performance mentioned on nameplate may vary as we are always improving our products

Material of Construction:

| No. | Part | Material |
|-----|---------------------------------|-------------------------------|
| 1 | End Shield (NDE)/ Lower Housing | Cast Iron-Grade FG 200 |
| 2 | Impeller | Cast Iron-Grade FG 200 |
| 3 | Volute | Cast Iron-Grade FG 200 |
| 4 | Motor body with grade. | Cast Iron-Grade FG 200 |
| 5 | Adaptor / Upper Housing. | Cast Iron-Grade FG 200 |
| 6 | Stamping material | CRNGO-M47 |
| 7 | Motor shaft | Stainless Steel-SS410 |
| 8 | DE/NDE bearing | Carbon Vs SS on DE & NDE side |
| 9 | Strainer | Nylon |
| 10 | Bearing Bush | Bronze LTB-4 |
| 11 | Delivery Flange | Cast Iron-Grade FG 200 |
| 12 | Fasteners | Stainless Steel-SS202 |
| 13 | Mechanical Seal | Carbon Vs Ceramic |

Pump Dimensional Details:

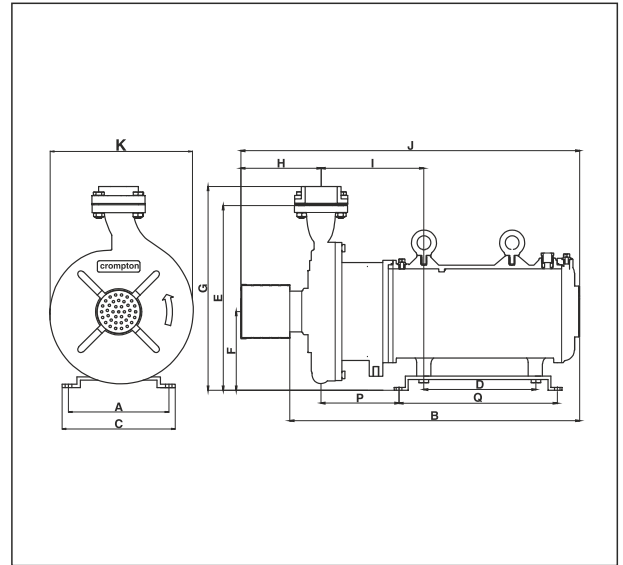

| Model Name | Pipe Size (mm) | All Dimensions are in mm | | | | | | | | | | | | | |
|---------------|----------------|--------------------------|-----|-----|-----|-----|-----|-----|-----|-----|-----|-----|-----|-----|--|
| | | A | B | C | D | E | F | G | H | I | J | K | P | Q | |
| OWKS32G-36U | 50X40 | 65 | 456 | 175 | 161 | 315 | 134 | 348 | 133 | 168 | 547 | 225 | 168 | 161 | |
| OWNH32G-27U | 65X50 | 65 | 456 | 175 | 161 | 290 | 134 | 323 | 147 | 171 | 547 | 226 | 171 | 161 | |
| OWO32G-23U | 65X65 | 65 | 472 | 175 | 161 | 290 | 134 | 323 | 147 | 178 | 563 | 232 | 178 | 161 | |
| OWKS52G-48U | 50X40 | 65 | 512 | 175 | 197 | 331 | 144 | 364 | 130 | 80 | 603 | 254 | 80 | 197 | |
| OWN52G-38U | 65X50 | 65 | 511 | 175 | 197 | 312 | 144 | 345 | 139 | 86 | 602 | 229 | 86 | 197 | |
| OWP52G-28U | 80X65 | 65 | 527 | 175 | 197 | 300 | 144 | 333 | 147 | 84 | 618 | 238 | 84 | 197 | |
| OWNS7.52G-57U | 80X50 | 65 | 560 | 175 | 197 | 334 | 144 | 367 | 143 | 85 | 651 | 281 | 85 | 197 | |
| OWR7.52G-30U | 100X80 | 65 | 574 | 175 | 197 | 327 | 144 | 360 | 205 | 90 | 665 | 262 | 90 | 197 | |
| OWS7.52G-25U | 100X100 | 65 | 576 | 175 | 197 | 327 | 144 | 360 | 207 | 91 | 667 | 270 | 91 | 197 | |

Openwell Submersible Pumps (Horizontal)



Less Power Consumption

High operating efficiency results in high flow rate and low electricity bill



*Wide Voltage Application

Designed to withstand wide voltage fluctuations from 250V-440V & Provides Consistent Performance



Anti-Rust CED Coating

Offers rust Free & stuck free Operation



Effective Sealing

Motor is sealed effectively using high quality Mechanical seal which ensures adequate water for motor cooling



High Grade Electrical Stamping

Reduces electrical losses & improves pump efficiency



Easy for Maintenance

Simple construction, easily replaceable wear & tear parts

Technical Specifications:

- Range: 1.5HP to 30HP (0.75kW to 22kW)
- Voltage range: 350-440V
250-440V(Wide voltage models)
160-240V(1Ph models)
- Rated Frequency: 50Hz
- Delivery pipe Size: 32 mm to 100 mm
- Max. head: Upto 78 Meters
- Max. Discharge: Upto 2225 LPM
- Liquid: Clear Water
- Rotation: Clockwise as viewed from Motor end
- Connection: Star (Upto 7.5 HP)
Delta (Above 7.5 HP)
- Motor Type : Water filled Motor

Applications:

- Agricultural farms
- Sprinkler irrigation
- Drinking water Supplies
- Water supply for industrial
- Drip irrigation
- Gardening



Performance Curve:

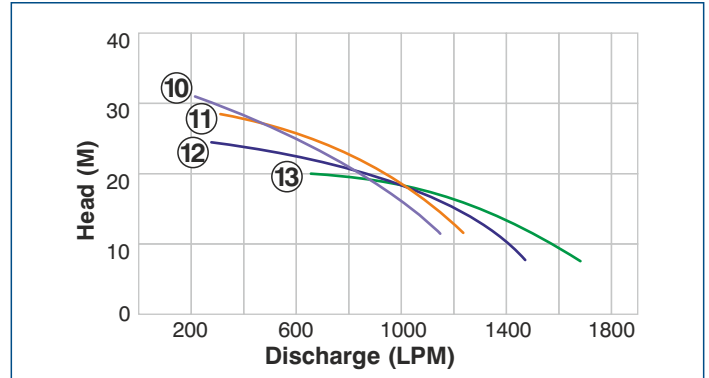
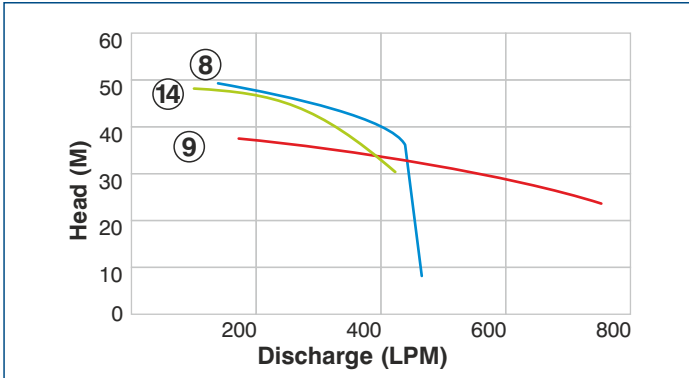
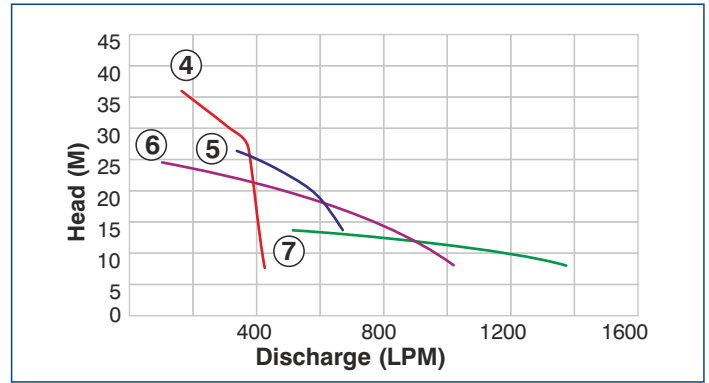
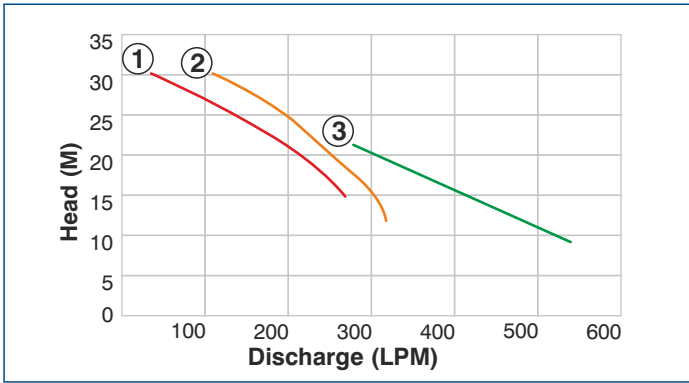

Performance Table:

| Sr. No. | Rating | Motor | | Outlet Size (mm) | Head in Meter | | | | | | | |
|---------|-------------|-------|-----|------------------|------------------|-----|-----|-----|-----|-----|-----|-----|
| | | kW | HP | | 9 | 12 | 15 | 18 | 21 | 24 | 27 | 30 |
| | | | | | Discharge in LPM | | | | | | | |
| *1 | OWG1.52G-30 | 1.1 | 1.5 | 32 | - | - | 270 | 240 | 200 | 155 | 100 | 35 |
| *2 | OWK22G-30 | 1.5 | 2 | 40 | - | 320 | 305 | 275 | 240 | 210 | 170 | 110 |
| *3 | OWM22G-21 | 1.5 | 2 | 50 | 540 | 480 | 420 | 355 | 280 | - | - | - |

| Sr. No. | Rating | Motor | | Outlet Size (mm) | Head in Meter | | | | | | | |
|---------|------------|-------|----|------------------|------------------|-----|---------|-----|-----|---------|-----|-----|
| | | kW | HP | | 8 | 12 | 16 | 20 | 24 | 28 | 32 | 36 |
| | | | | | Discharge in LPM | | | | | | | |
| *4 | OWKS32G-36 | 2.2 | 3 | 40 | 420 | 415 | 400 | 385 | 370 | 350 | 265 | 168 |
| *5 | OWNH32G-27 | 2.2 | 3 | 50 | - | - | 638 | 535 | 427 | 350@27m | | - |
| *6 | OWO32G-23 | 2.2 | 3 | 65 | 1025 | 885 | 700 | 475 | 110 | - | - | - |
| *7 | OWS32G-14 | 2.2 | 3 | 100 | 1380 | 950 | 525@14m | | - | - | - | - |

| Sr. No. | Rating | Motor | | Outlet Size (mm) | Head in Meter | | | | | | | | |
|---------|------------|-------|----|------------------|------------------|------|------|-----|-----|---------|---------|---------|-----|
| | | kW | HP | | 8 | 12 | 16 | 20 | 24 | 28 | 36 | 40 | 48 |
| | | | | | Discharge in LPM | | | | | | | | |
| *8 | OWKS52G-48 | 3.7 | 5 | 40 | 480 | 475 | 470 | 465 | 460 | 460 | 440 | 390 | 160 |
| *9 | OWN52G-38 | 3.7 | 5 | 50 | - | - | - | - | 760 | 650 | 315 | 180@38m | |
| *10 | OWO52G-30 | 3.7 | 5 | 65 | - | 1150 | 1035 | 890 | 680 | 425 | 210@30m | | - |
| *11 | OWP52G-28 | 3.7 | 5 | 65 | - | 1260 | 1100 | 925 | 725 | 325 | - | - | - |
| *12 | OWQ52G-25 | 3.7 | 5 | 80 | 1480 | 1365 | 1175 | 925 | 475 | 275@25m | | - | - |
| *13 | OWS52G-20 | 3.7 | 5 | 100 | 1690 | 1600 | 1300 | 660 | - | - | - | - | - |

| Sr. No. | Rating | Motor | | Outlet Size (mm) | Head in Meter | | | | | | |
|---------|--------------------|-------|----|------------------|------------------|-----|-----|-----|-----|-----|-----|
| | | kW | HP | | 30 | 33 | 36 | 39 | 42 | 45 | 48 |
| | | | | | Discharge in LPM | | | | | | |
| 14 | OWM52(1PH)G-48-WOP | 3.7 | 5 | 50 | 425 | 410 | 405 | 380 | 340 | 250 | 100 |

Performance Curve:

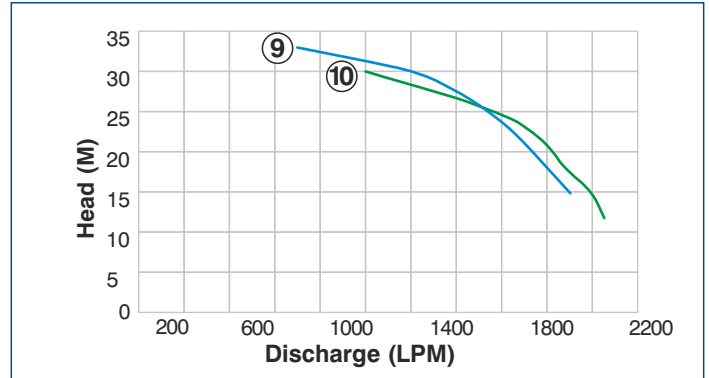
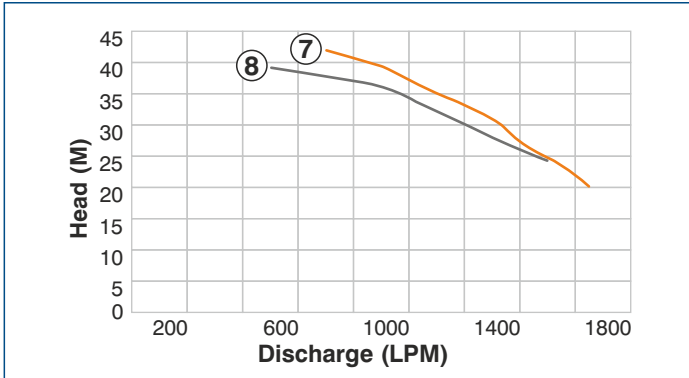
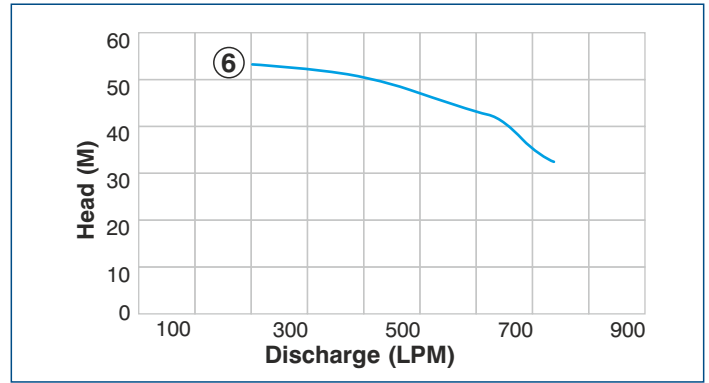
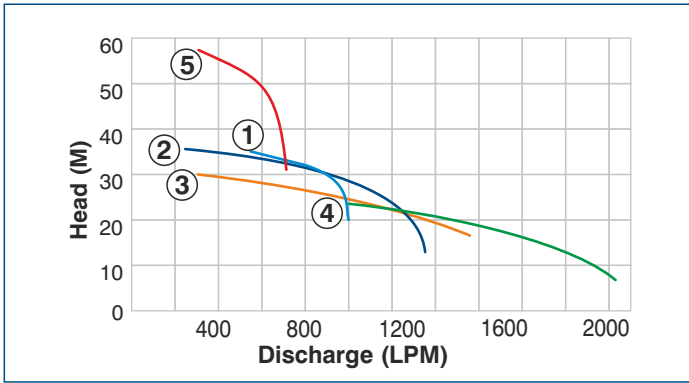

Performance Table:

| Sr. No. | Rating | Motor | | Outlet Size (mm) | Head in Meter | | | | | | | |
|---------|-------------|-------|-----|------------------|---------------|------|------|------|------|------|---------|----|
| | | kW | HP | | 8 | 12 | 16 | 20 | 24 | 28 | 36 | 40 |
| *1 | OWP7.52G-36 | 5.5 | 7.5 | 65 | - | - | - | 1000 | 1000 | 950 | 575 | - |
| *2 | OWQ7.52G-36 | 5.5 | 7.5 | 80 | - | 1340 | 1340 | 1305 | 1200 | 1025 | 225 | - |
| *3 | OWR7.52G-30 | 5.5 | 7.5 | 80 | - | - | 1550 | 1350 | 1060 | 680 | 280@30m | |
| *4 | OWS7.52G-25 | 5.5 | 7.5 | 100 | 2025 | 1925 | 1780 | 1520 | 1000 | - | - | - |

| Sr. No. | Rating | Motor | | Outlet Size (mm) | Head in Meter | | | | | | | | |
|---------|--------------|-------|-----|------------------|---------------|-----|-----|-----|-----|-----|-----|-----|-----|
| | | kW | HP | | 33 | 36 | 39 | 42 | 45 | 48 | 51 | 54 | 57 |
| *5 | OWNS7.52G-57 | 5.5 | 7.5 | 50 | 650 | 640 | 630 | 625 | 620 | 610 | 575 | 450 | 275 |

| Sr. No. | Rating | Motor | | Outlet Size (mm) | Head in Meter | | | | | | | |
|---------|--------------|-------|----|------------------|---------------|-----|-----|-----|-----|-----|-----|-----|
| | | kW | HP | | 33 | 36 | 39 | 42 | 45 | 48 | 51 | 54 |
| *6 | OWNH10.2G-54 | 7.5 | 10 | 50 | 740 | 700 | 675 | 650 | 575 | 500 | 400 | 200 |

| Sr. No. | Rating | Motor | | Outlet Size (mm) | Head in Meter | | | | | | | |
|---------|--------------|-------|----|------------------|---------------|------|------|------|------|------|-----|-----|
| | | kW | HP | | 20 | 24 | 27 | 30 | 33 | 36 | 39 | 42 |
| *7 | OWPH10.2G-42 | 7.5 | 10 | 65 | 1650 | 1525 | 1410 | 1325 | 1200 | 1040 | 900 | 700 |
| *8 | OWQH10.2G-39 | 7.5 | 10 | 80 | - | 1500 | 1350 | 1200 | 1050 | 900 | 500 | - |

| Sr. No. | Rating | Motor | | Outlet Size (mm) | Head in Meter | | | | | | | |
|---------|-------------|-------|----|------------------|---------------|------|------|------|------|------|------|-----|
| | | kW | HP | | 12 | 15 | 18 | 21 | 24 | 27 | 30 | 33 |
| *9 | OWR10.2G-33 | 7.5 | 10 | 80 | - | 1900 | 1800 | 1700 | 1590 | 1430 | 1200 | 700 |
| *10 | OWS10.2G-30 | 7.5 | 10 | 100 | 2050 | 1990 | 1880 | 1790 | 1650 | 1370 | 1000 | - |

Performance Curve:

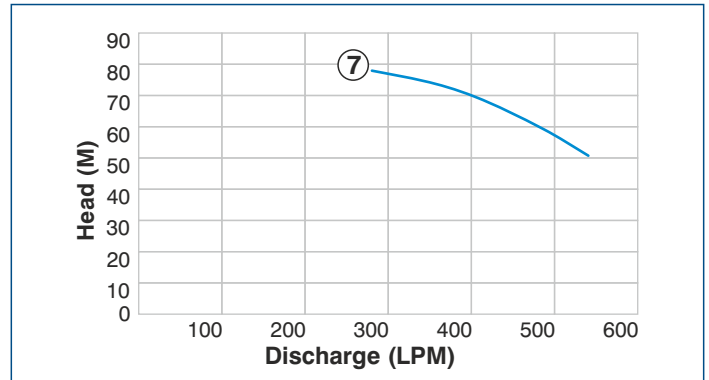
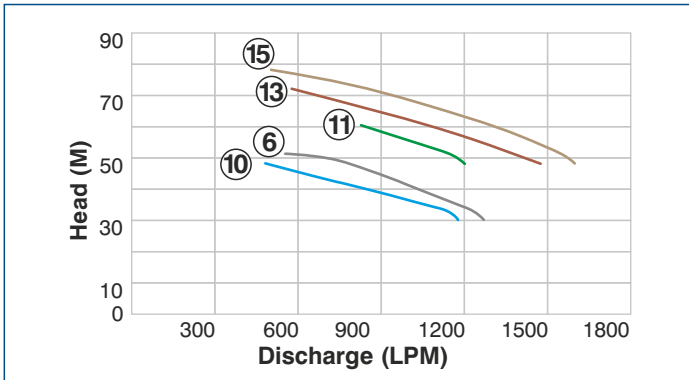
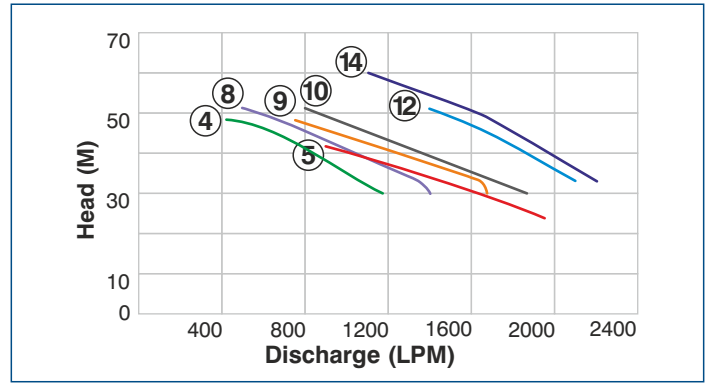
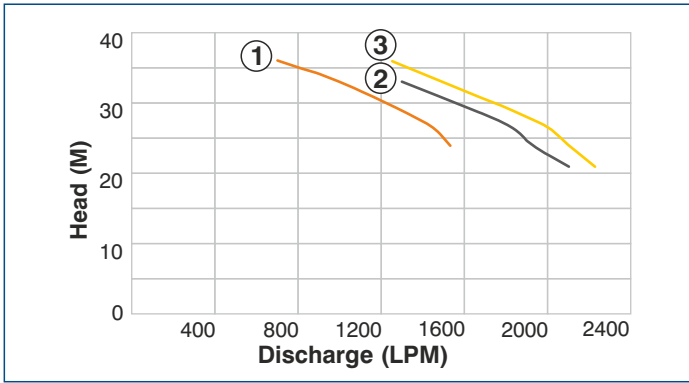

Performance Table:

| Sr. No. | Rating | Motor | | Outlet Size (mm) | Head in Meter | | | | |
|---------|-----------|-------|------|------------------|------------------|------|------|------|------|
| | | kW | HP | | 21 | 24 | 27 | 33 | 36 |
| | | | | | Discharge in LPM | | | | |
| 1 | OWQH12.52 | 9.3 | 12.5 | 80 | - | 1530 | 1420 | 1000 | 700 |
| 2 | OWS12.52 | 9.3 | 12.5 | 100 | 2100 | 1925 | 1800 | 1300 | - |
| 3 | OWS15.2 | 11 | 15 | 100 | 2225 | 2100 | 1970 | 1500 | 1250 |

| Sr. No. | Rating | Motor | | Outlet Size (mm) | Head in Meter | | | | | | | |
|---------|-----------|-------|------|------------------|------------------|------|------|---------|------|------|-----|-----|
| | | kW | HP | | 24 | 30 | 33 | 48 | 51 | 60 | 72 | 78 |
| | | | | | Discharge in LPM | | | | | | | |
| 4 | OWPH12.52 | 9.3 | 12.5 | 65 | - | 1175 | 1125 | 480 | - | - | - | - |
| 5 | OWR15.2 | 11 | 15 | 80 | 1950 | 1700 | 1600 | 900@42m | | - | - | - |
| 6 | OWPH15.2 | 11 | 15 | 65 | - | 1270 | 1220 | 780 | 550 | - | - | - |
| 7 | OWNH15.2 | 11 | 15 | 50 | - | - | - | - | 540 | 480 | 380 | 280 |
| 8 | OWPH17.52 | 13 | 17.5 | 65 | - | 1400 | 1340 | 680 | 500 | - | - | - |
| 9 | OWQH17.52 | 13 | 17.5 | 80 | - | 1675 | 1640 | 750 | - | - | - | - |
| 10 | OWR20.2 | 15 | 20 | 80 | - | 1850 | 1750 | 1000 | 800 | - | - | - |
| 11 | OWPH20.2 | 15 | 20 | 65 | - | - | - | 1200 | 1150 | 825 | - | - |
| 12 | OWR25.2 | 18.5 | 25 | 80 | - | - | 2100 | 1525 | 1400 | - | - | - |
| 13 | OWPH25.2 | 18.5 | 25 | 65 | - | - | - | 1475 | 1375 | 1075 | 575 | - |
| 14 | OWR30.2 | 22 | 30 | 80 | - | - | 2200 | 1700 | 1575 | 1100 | - | - |
| 15 | OWPH30.2 | 22 | 30 | 65 | - | - | - | 1600 | 1550 | 1300 | 850 | 500 |

Performance Curve:

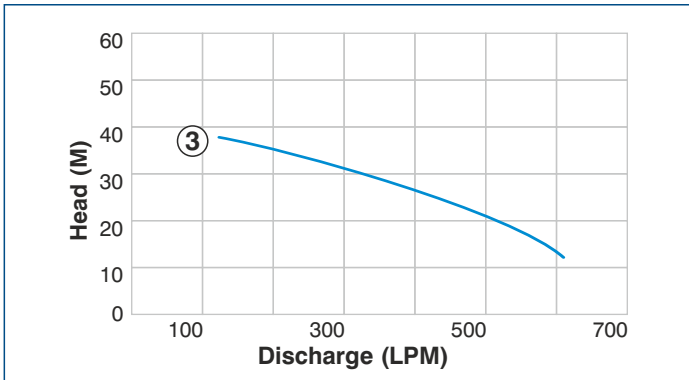
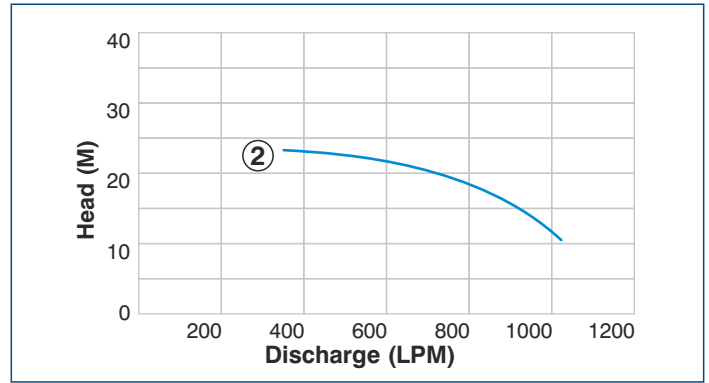
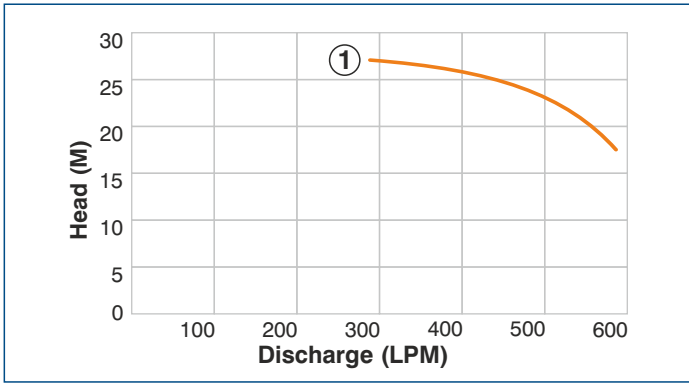

Performance Table:

| Sr. No. | Rating | Motor | | Outlet Size (mm) | Head in Meter | | | | | | | | |
|---------|-----------------|-------|----|------------------|------------------|-----|-----|-----|---------|-----|----|----|----|
| | | kW | HP | | 11 | 15 | 18 | 21 | 24 | 27 | 30 | 33 | 38 |
| | | | | | Discharge in LPM | | | | | | | | |
| 1 | OWNH32(1PH)G-27 | 2.2 | 3 | 50 | - | - | 590 | 500 | 420 | 290 | - | - | - |
| 2 | OWO32(1PH)G-23 | 2.2 | 3 | 65 | 1020 | 840 | 680 | 500 | 350@23M | | - | - | - |

| Sr. No. | Rating | Motor | | Outlet Size (mm) | Head in Meter | | | | | | | | |
|---------|--------------------|-------|----|------------------|------------------|-----|-----|-----|-----|-----|-----|-----|-----|
| | | kW | HP | | 12 | 15 | 18 | 21 | 24 | 27 | 30 | 33 | 36 |
| | | | | | Discharge in LPM | | | | | | | | |
| 3 | OWM32(1PH)G-36-WOP | 2.2 | 3 | 50 | 610 | 575 | 480 | 470 | 430 | 370 | 310 | 225 | 125 |

Note :

1. The motor ratings in HP are only indicative and for reference purpose
2. Performance figures given above are approximate and may differ on site conditions

3. Performance mentioned on nameplate may vary as we are always improving our products
4. * Models are with CED Coating, Mechanical Seal and wide voltage operation

Material of Construction:

| No. | Part | Material |
|-----|---------------------------------|-------------------------------|
| 1 | End Shield (NDE)/ Lower Housing | Cast Iron-Grade FG 200 |
| 2 | Impeller | Cast Iron-Grade FG 200 |
| 3 | Volute | Cast Iron-Grade FG 200 |
| 4 | Motor body with grade. | Cast Iron-Grade FG 200 |
| 5 | Adaptor / Upper Housing. | Cast Iron-Grade FG 200 |
| 6 | Stamping material | CRNGO-M47 |
| 7 | Motor shaft | Stainless Steel-SS410 |
| 8 | DE/NDE bearing | Carbon Vs SS on DE & NDE side |
| 9 | Strainer | Stainless Steel-SS202/Nylon |
| 10 | Bearing Bush | Bronze LTB-4 |
| 11 | Delivery Flange | Cast Iron-Grade FG 200 |
| 12 | Fasteners | Stainless Steel-SS202 |
| 13 | Mechanical Seal | Carbon Vs Ceramic |

Pump Dimensional Details:

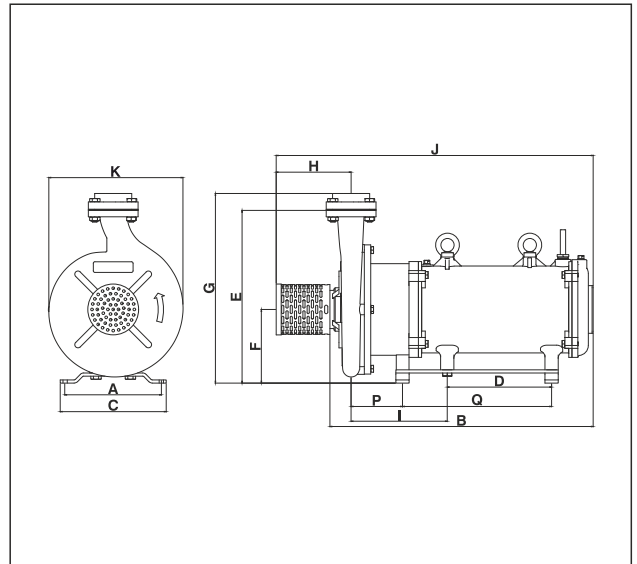

| Model Name | Pipe Size (mm) | All Dimensions are in mm | | | | | | | | | | | | |
|--------------|----------------|--------------------------|-----|-----|-----|-----|-----|-----|-----|-----|-----|-----|-----|-----|
| | | A | B | C | D | E | F | G | H | I | J | K | P | Q |
| OWKS32G-36 | 50x40 | 65 | 436 | 200 | 142 | 315 | 134 | 348 | 133 | 231 | 611 | 225 | 231 | 142 |
| OWM32G-36 | 50X50 | 65 | 436 | 200 | 142 | 315 | 134 | 348 | 133 | 231 | 611 | 225 | 231 | 142 |
| OWNH32G-27 | 65X50 | 65 | 447 | 200 | 142 | 290 | 134 | 323 | 147 | 238 | 632 | 226 | 238 | 142 |
| OWO32G-23 | 65X65 | 65 | 448 | 200 | 142 | 290 | 134 | 323 | 147 | 239 | 633 | 232 | 239 | 142 |
| OWS32G-14 | 100X100 | 65 | 457 | 200 | 142 | 317 | 134 | 350 | 207 | 243 | 697 | 270 | 243 | 142 |
| OWKS52G-48 | 50x40 | 65 | 427 | 200 | 142 | 321 | 134 | 354 | 130 | 225 | 602 | 254 | 225 | 142 |
| OWM52G-45 | 50x50 | 65 | 427 | 200 | 142 | 321 | 134 | 354 | 130 | 225 | 602 | 254 | 225 | 142 |
| OWN52G-38 | 65X50 | 65 | 432 | 200 | 142 | 302 | 134 | 335 | 139 | 231 | 617 | 229 | 231 | 142 |
| OWO52G-30 | 65X65 | 65 | 448 | 200 | 142 | 290 | 134 | 323 | 147 | 239 | 633 | 232 | 239 | 142 |
| OWP52G-28 | 80X65 | 65 | 448 | 200 | 142 | 290 | 134 | 323 | 147 | 239 | 633 | 238 | 239 | 142 |
| OWQ52G-25 | 80X80 | 65 | 448 | 200 | 142 | 306 | 134 | 339 | 147 | 239 | 633 | 242 | 239 | 142 |
| OWS52G-20 | 100X100 | 65 | 457 | 200 | 142 | 317 | 134 | 350 | 207 | 243 | 697 | 270 | 243 | 142 |
| OWNS7.52G-57 | 65X50 | 65 | 472 | 200 | 142 | 326 | 134 | 359 | 138 | 232 | 657 | 282 | 232 | 142 |
| OWP7.52G-36 | 80X65 | 65 | 483 | 200 | 142 | 328 | 134 | 361 | 149 | 232 | 668 | 269 | 232 | 142 |
| OWQ7.52G-36 | 80X80 | 65 | 486 | 200 | 142 | 317 | 134 | 350 | 145 | 239 | 671 | 250 | 239 | 142 |
| OWR7.52G-30 | 100X80 | 65 | 495 | 200 | 142 | 317 | 134 | 350 | 205 | 243 | 735 | 262 | 243 | 142 |
| OWS7.52G-25 | 100X100 | 65 | 497 | 200 | 142 | 317 | 134 | 350 | 207 | 243 | 737 | 270 | 243 | 142 |

| Model Name | Pipe Size (mm) | All Dimensions are in mm | | | | | | | | | | | | |
|--------------|----------------|--------------------------|-----|-----|-----|-------|-------|-------|-----|-----|-----|-----|-------|-----|
| | | A | B | C | D | E | F | G | H | I | J | K | P | Q |
| OWNH10.2G-54 | 65X50 | 208 | 570 | 255 | 180 | 405.5 | 176.5 | 431.5 | 154 | 200 | 661 | 264 | 142.5 | 295 |
| OWPH10.2G-42 | 80X65 | 208 | 576 | 255 | 180 | 385.5 | 176.5 | 411.5 | 157 | 203 | 667 | 262 | 145.5 | 295 |
| OWQH10.2G-39 | 80X80 | 208 | 598 | 255 | 180 | 386.5 | 176.5 | 412.5 | 161 | 221 | 689 | 281 | 163.5 | 295 |
| OWR10.2G-33 | 100X80 | 208 | 583 | 255 | 180 | 414.5 | 176.5 | 445.5 | 205 | 204 | 716 | 310 | 146.5 | 295 |
| OWS10.2G-30 | 100X100 | 208 | 586 | 255 | 180 | 389.5 | 176.5 | 415.5 | 205 | 207 | 719 | 286 | 149.5 | 295 |

| Model Name | Pipe Size (mm) | All Dimensions are in mm | | | | | | | | | | | | |
|--------------------|----------------|--------------------------|-----|-----|-----|-----|-----|-----|-----|-----|-----|-----|-----|-----|
| | | A | B | C | D | E | F | G | H | I | J | K | P | Q |
| OWM52(1PH)G-48-WOP | 50X50 | 65 | 427 | 200 | 142 | 321 | 134 | 354 | 130 | 225 | 602 | 254 | 225 | 142 |

| Model Name | Pipe Size (mm) | All Dimensions are in mm | | | | | | | | | | | | |
|-----------------|----------------|--------------------------|-----|-----|-----|-----|-----|-----|-----|-----|-----|-----|-----|-----|
| | | A | B | C | D | E | F | G | H | I | J | K | P | Q |
| OWNH32(1PH)G-27 | 65X50 | 65 | 447 | 200 | 142 | 290 | 134 | 323 | 147 | 238 | 632 | 226 | 238 | 142 |
| OWO32(1PH)G-23 | 65X65 | 65 | 448 | 200 | 142 | 290 | 134 | 323 | 147 | 239 | 633 | 232 | 239 | 142 |
| OWN52(1PH)G-38 | 65X50 | 65 | 432 | 200 | 142 | 302 | 134 | 335 | 139 | 231 | 617 | 229 | 231 | 142 |

| Model Name | Pipe Size (mm) | All Dimensions are in mm | | | | | | | | | | |
|------------|----------------|--------------------------|-----|-----|-----|-----|-----|-----|-----|-----|-----|-----|
| | | A | B | C | D | E | F | G | H | I | J | K |
| OWPH12.52 | 80X65 | 210 | 583 | 260 | 252 | 400 | 160 | 440 | 210 | 170 | 666 | 296 |
| OWQH12.52 | 80X80 | 210 | 589 | 260 | 252 | 400 | 160 | 440 | 216 | 158 | 672 | 330 |
| OWS12.52 | 100X100 | 210 | 630 | 280 | 252 | 380 | 160 | 460 | 256 | 173 | 713 | 286 |
| OWNH15.2 | 65X50 | 250 | 565 | 280 | 280 | 405 | 160 | 461 | 213 | 194 | 711 | 260 |
| OWPH15.2 | 80X65 | 250 | 565 | 280 | 280 | 405 | 160 | 461 | 213 | 194 | 711 | 284 |
| OWR15.2 | 100X80 | 250 | 606 | 280 | 280 | 405 | 160 | 464 | 261 | 194 | 759 | 310 |
| OWS15.2 | 100X100 | 250 | 603 | 280 | 280 | 395 | 160 | 445 | 258 | 197 | 756 | 286 |
| OWPH17.52 | 80X65 | 250 | 565 | 280 | 280 | 405 | 160 | 302 | 213 | 194 | 711 | 295 |
| OWQH17.52 | 80X80 | 250 | 606 | 280 | 280 | 400 | 160 | 305 | 261 | 182 | 759 | 330 |
| OWPH20.2 | 80X65 | 250 | 586 | 280 | 280 | 410 | 160 | 471 | 215 | 194 | 742 | 312 |
| OWR20.2 | 100X80 | 250 | 644 | 280 | 280 | 410 | 160 | 484 | 256 | 194 | 783 | 330 |
| OWPH25.2 | 80X65 | 250 | 663 | 300 | 304 | 460 | 190 | 491 | 215 | 190 | 811 | 334 |
| OWR25.2 | 100X80 | 250 | 703 | 300 | 304 | 460 | 190 | 483 | 255 | 190 | 851 | 330 |
| OWPH30.2 | 80X65 | 250 | 663 | 300 | 304 | 460 | 190 | 491 | 215 | 190 | 811 | 334 |
| OWR30.2 | 100X80 | 250 | 703 | 300 | 304 | 460 | 190 | 483 | 255 | 190 | 851 | 330 |

| Model Name | Pipe Size (mm) | All Dimensions are in mm | | | | | | | | | | | | | | |
|-------------|----------------|--------------------------|-----|-----|-----|-----|-----|-----|-----|----|-----|-----|----|----|-----|-----|
| | | A | B | C | D | E | F | G | H | I | J | K | K1 | K2 | L | M |
| OWG1.52G-30 | 40X32 | 135 | 408 | 162 | 234 | 121 | 256 | 284 | 122 | 44 | 478 | 192 | 93 | 98 | 195 | 163 |
| OWK22G-30 | 50X40 | 135 | 408 | 162 | 234 | 121 | 256 | 284 | 122 | 44 | 478 | 192 | 93 | 98 | 195 | 163 |

Openwell Submersible Pumps (Vertical)



Less Power Consumption

High operating efficiency results in high flow rate and low electricity bill



Wide Voltage Application

Designed to withstand wide voltage fluctuations from 250V-440V & Provides Consistent Performance



High Thrust Capacity

Specially designed thrust bearing ensures highest reliability



Easy for Maintenance

Simple construction, easily replaceable wear and tear parts

Technical Specifications:

- Range: 1HP to 20HP (0.75kW to 15kW)
- Voltage range: 250-440V(3 Ph models)
160-240V(1 Ph models)
- Rated Frequency: 50Hz
- Delivery pipe Size: 32 mm to 100 mm
- Max. head: Upto 147 Meters
- Max. Discharge: Upto 1800 LPM
- Liquid: Clear Water
- Rotation: Clockwise as viewed from Motor end
- Connection: Series Parallel (1Ph model)
Star (Upto 7.5 HP)
Delta (Above 7.5 HP)
- Motor type: Water Filled motor

Application:

- Agricultural farms
- Sprinkler irrigation
- Drinking water Supplies
- Water supply for industrial
- Drip irrigation
- Gardening



Performance Curve 1 Phase:

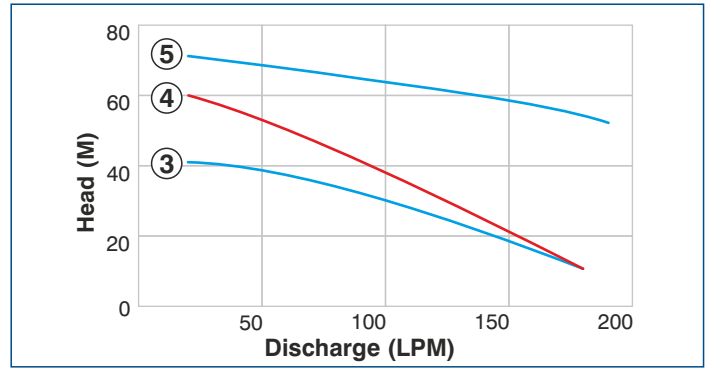
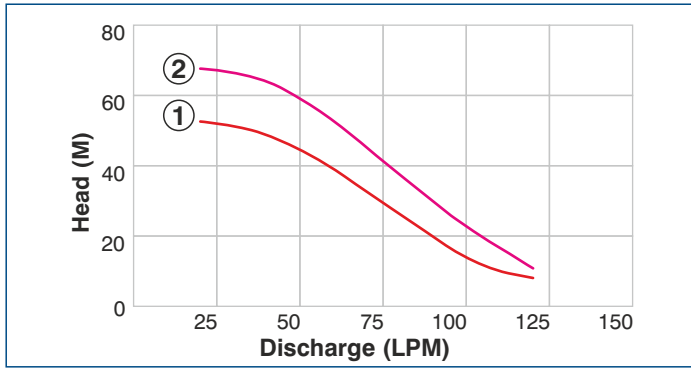

Performance Table 1 Phase:

| Sr. No. | Rating | No. of Stages | Motor | | Outlet Size (mm) | Discharge in LPM | | | | | |
|---------|--------------|---------------|-------|-----|------------------|------------------|----|----|-----|-----|-----|
| | | | kW | HP | | 20 | 40 | 60 | 100 | 120 | 180 |
| | | | | | | Head in Meter | | | | | |
| 1 | CROVOS7B-1 | 7 | 0.75 | 1.0 | 32 | 53 | 49 | 39 | 14 | 8 | - |
| 2 | CROVOS10B-1 | 10 | 0.75 | 1.0 | 32 | 68 | 64 | 53 | 23 | 11 | - |
| 3 | CROVOS6C-1 | 6 | 0.75 | 1.0 | 32 | 41 | 40 | 38 | 34 | 29 | 11 |
| 4 | CROVOS9C-1.5 | 9 | 1.1 | 1.5 | 32 | 60 | 57 | 55 | 48 | 41 | 11 |

| Sr. No. | Rating | No. of Stages | Motor | | Outlet Size (mm) | Discharge in LPM | | | | | |
|---------|---------------|---------------|-------|-----|------------------|------------------|----|----|-----|-----|-----|
| | | | kW | HP | | 20 | 40 | 60 | 100 | 120 | 180 |
| | | | | | | Head in Meter | | | | | |
| 5 | CROVOS8R2-1.5 | 8 | 1.1 | 1.5 | 32 | 71 | 68 | 63 | 60 | 57 | 52 |

Note :

- The motor ratings in HP are only indicative and for reference purpose
- Performance figures given above are approximate and may differ on site conditions

3. Performance mentioned on nameplate may vary as we are always improving our products

Material of Construction 1 Phase:

| Sr. No. | Part | Material |
|---------|-------------------------|------------------------|
| 1 | Lower Housing | Cast Iron-Grade FG 200 |
| 2 | Impeller | Noryl |
| 3 | Diffuser/Bowl | Noryl |
| 4 | Motor body with grade | Stainless Steel-SS202 |
| 5 | Adaptor / Upper Housing | Cast Iron-Grade FG 200 |
| 6 | Stamping material | CRNGO-M47 |
| 7 | Motor shaft | Stainless Steel-SS410 |
| 8 | Thrust bearing | Carbon Vs SS |
| 9 | Strainer | Stainless Steel-SS202 |
| 10 | Bearing Bush | NBR+SS |
| 11 | Delivery Flange | Cast Iron-Grade FG 200 |
| 12 | Fasteners | Stainless Steel-SS202 |

Pump Dimensional Details: 1 Phase:

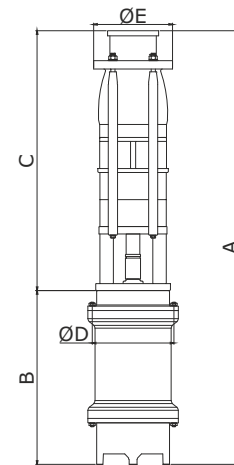

| Rating | All Dimensions are in mm | | | | | | |
|---------------|--------------------------|------------|-----------|----------------------|---------------------|------------------------------|-----------------------------------|
| | Total Length A=B+C | Motor B | Pump C | Motor OD (dia.) D | Pump OD (dia.) E | Motor OD (With Brg Block) | Pump OD (With Delivery Flange) |
| CROVOS6C-1 | 655 | 295 | 360 | 130 | 105 | 138 | 115 |
| CROVOS7B-1 | 650 | 295 | 355 | 130 | 105 | 138 | 115 |
| CROVOS10B-1 | 720 | 295 | 425 | 130 | 105 | 138 | 115 |
| CROVOS9C-1.5 | 775 | 325 | 450 | 130 | 105 | 138 | 115 |
| CROVOS8R2-1.5 | 740 | 325 | 415 | 130 | 105 | 138 | 115 |

Performance Curve 3 Phase:

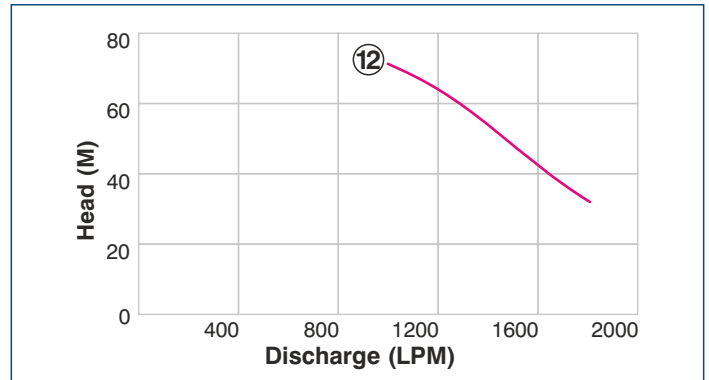
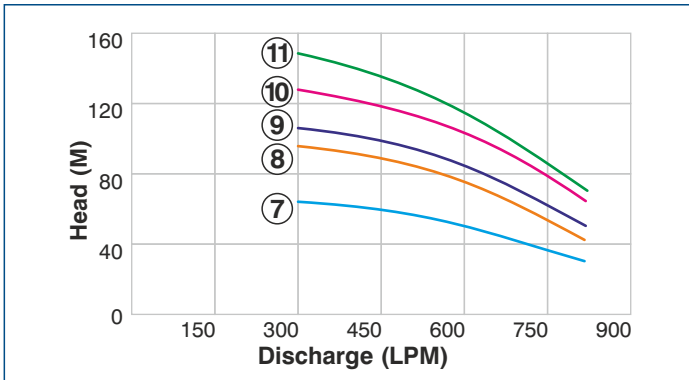
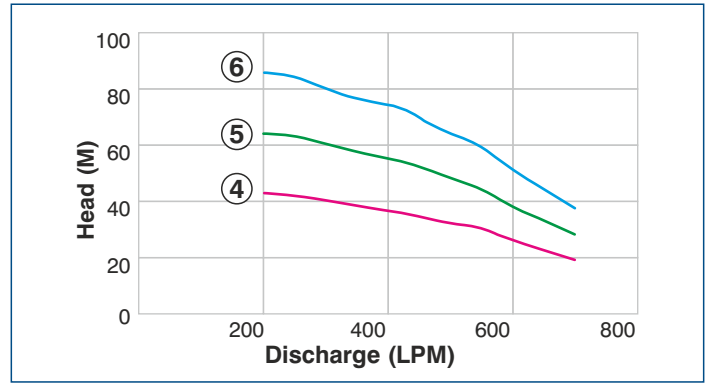
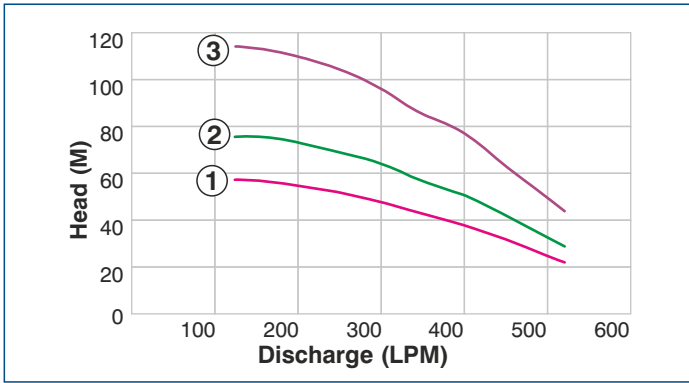

Performance Table 3 Phase:

| Sr. No. | Rating | No. of Stages | Motor | | Outlet Size (mm) | Discharge in LPM | | | | | | | |
|---------|----------------|---------------|-------|-----|------------------|------------------|-----|-----|-----|-----|-----|-----|-----|
| | | | kW | HP | | 125 | 170 | 250 | 300 | 340 | 400 | 450 | 520 |
| | | | | | | Head in Meter | | | | | | | |
| 1 | CROVOS3T25-5 | 3 | 3.7 | 5 | 50 | 57 | 56 | 52 | 48 | 44 | 38 | 32 | 22 |
| 2 | CROVOS4T25-7.5 | 4 | 5.5 | 7.5 | 50 | 76 | 75 | 69 | 64 | 58 | 51 | 42 | 29 |
| 3 | CROVOS6T25-10 | 6 | 7.5 | 10 | 50 | 114 | 112 | 104 | 96 | 87 | 77 | 63 | 44 |

| Sr. No. | Rating | No. of Stages | Motor | | Outlet Size (mm) | Discharge in LPM | | | | | | | |
|---------|----------------|---------------|-------|-----|------------------|------------------|-----|-----|-----|-----|-----|-----|-----|
| | | | kW | HP | | 200 | 250 | 340 | 420 | 480 | 550 | 600 | 700 |
| | | | | | | Head in Meter | | | | | | | |
| 4 | CROVOS2T30-5 | 2 | 3.7 | 5 | 65 | 43 | 42 | 39 | 36 | 33 | 30 | 26 | 19 |
| 5 | CROVOS3T30-7.5 | 3 | 5.5 | 7.5 | 65 | 64 | 63 | 58 | 54 | 50 | 44 | 38 | 28 |
| 6 | CROVOS4T30-10 | 4 | 7.5 | 10 | 65 | 86 | 84 | 77 | 73 | 66 | 59 | 51 | 37 |

| Sr. No. | Rating | No. of Stages | Motor | | Outlet Size (mm) | Discharge in LPM | | | | | | | |
|---------|-----------------|---------------|-------|------|------------------|------------------|-----|-----|-----|-----|-----|-----|-----|
| | | | kW | HP | | 300 | 450 | 480 | 550 | 650 | 700 | 760 | 820 |
| | | | | | | Head in Meter | | | | | | | |
| 7 | CROVOS3T35-10 | 3 | 7.5 | 10 | 65 | 63 | 62 | 60 | 56 | 51 | 44 | 36 | 32 |
| 8 | CROVOS4T35-12.5 | 4 | 9.3 | 12.5 | 65 | 96 | 82 | 80 | 74 | 68 | 59 | 48 | 42 |
| 9 | CROVOS5T35-15 | 5 | 11 | 15 | 65 | 105 | 103 | 100 | 93 | 85 | 73 | 60 | 53 |
| 10 | CROVOS6T35-17.5 | 6 | 13 | 17.5 | 65 | 126 | 124 | 120 | 112 | 102 | 88 | 72 | 64 |
| 11 | CROVOS7T35-20 | 7 | 15 | 20 | 65 | 147 | 144 | 140 | 130 | 119 | 102 | 84 | 74 |

| Sr. No. | Rating | No. of Stages | Motor | | Outlet Size (mm) | Discharge in LPM | | | | |
|---------|----------------|---------------|-------|----|------------------|------------------|------|------|------|------|
| | | | kW | HP | | 1000 | 1250 | 1550 | 1700 | 1800 |
| | | | | | | Head in Meter | | | | |
| 12 | CROVOS5M35HB20 | 5 | 15 | 20 | 100 | 72 | 60 | 42 | 33 | 32 |

Note :

1. The motor ratings in HP are only indicative and for reference purpose
2. Performance figures given above are approximate and may differ on site conditions

3. Performance mentioned on nameplate may vary as we are always improving our products

Material of Construction 3 Phase:

| Sr. No. | Part | Material |
|---------|-------------------------|------------------------|
| 1 | Lower Housing | Cast Iron-Grade FG 200 |
| 2 | Impeller | Cast Iron-Grade FG 200 |
| 3 | Diffuser/Bowl | Cast Iron-Grade FG 200 |
| 4 | Motor body with grade. | Cast Iron-Grade FG 200 |
| 5 | Adaptor / Upper Housing | Cast Iron-Grade FG 200 |
| 6 | Motor shaft | Stainless Steel-SS410 |
| 7 | Thrust bearing | Carbon Vs SS |
| 8 | Strainer | Stainless Steel-SS202 |
| 9 | Bearing Bush | LTB-4 |
| 10 | Delivery Flange | Cast Iron-Grade FG 200 |
| 11 | Fasteners | Stainless Steel-SS202 |

Pump Dimensional Details: 3 Phase:

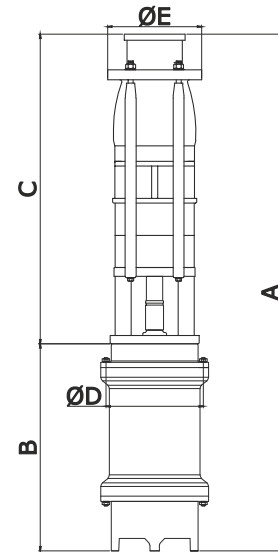

| Rating | All Dimensions are in mm | | | | |
|-----------------|--------------------------|------------|-----------|----------------------|---------------------|
| | Total Length A=B+C | Motor B | Pump C | Motor OD (dia.) D | Pump OD (dia.) E |
| CROVOS3T25-5 | 789 | 438 | 351 | 218 | 215 |
| CROVOS4T25-7.5 | 883 | 483 | 400 | 218 | 215 |
| CROVOS6T25-10 | 1016 | 518 | 498 | 218 | 215 |
| CROVOS2T30-5 | 750 | 438 | 312 | 218 | 215 |
| CROVOS3T30-7.5 | 849 | 483 | 366 | 218 | 215 |
| CROVOS4T30-10 | 938 | 518 | 420 | 218 | 215 |
| CROVOS3T35-10 | 1451 | 518 | 933 | 218 | 232 |
| CROVOS4T35-12.5 | 1601 | 538 | 1063 | 218 | 232 |
| CROVOS5T35-15 | 1761 | 568 | 1193 | 218 | 232 |
| CROVOS6T35-17.5 | 1931 | 608 | 1323 | 218 | 232 |
| CROVOS7T35-20 | 2101 | 648 | 1453 | 218 | 232 |
| CROVOS5M35HB20 | 1529 | 648 | 881 | 218 | 232 |

A woman is shown from the chest up, facing left, with her eyes closed and head tilted back, enjoying a shower. Water is spraying from a chrome showerhead onto her hair and shoulders. The background is bright and features green foliage. The overall scene is clean and refreshing.

Crompton

**Boost water pressure
not your expenses**

SPECIALITY PUMPS EXPLORER

Pressure Booster Pumps



CFCHM



CFMSMB



IPCHM



IPSSWJ



MINI FORCE



Automatic Operation

As per water requirement, pump automatically starts when pressure level drops below set pressure



Noiseless Operation

Pump noise is less than 60db



Brass Strainer

High quality Y-strainer provided to avoid foreign particle entry



Less Power Consumption

High operating efficiency results in high flow rate and low electricity bill

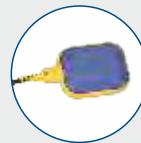

Dry Run Protection

CFCHM and CFMSMB: Provided by using float switch
IPCHM & IPSSWJ: Inbuilt dry run protection provided in controller

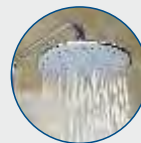

Constant Pressure Application

Gives constant pressure at all taps

Technical Specifications:

- Range : 0.5 HP to 1.5 HP (0.37kW to 1.1 kW)
- Rated Voltage : 220V 1PH
- Voltage Range : 180V - 260V
- Rated Frequency: 50Hz
- Pipe Size : 25mm X 25mm, 32mm X 25mm
- Max. head : Up to 56 Meters.
- Max. Discharge : Up to 130LPM.
- Liquid : Clear & Cold Water
- Rotation : clockwise as viewed from Motor End

Application:

- Domestic pressure boosting applications in bungalows, apartments, hotels, etc.
- For constant pressure application in industries



Performance Curve:

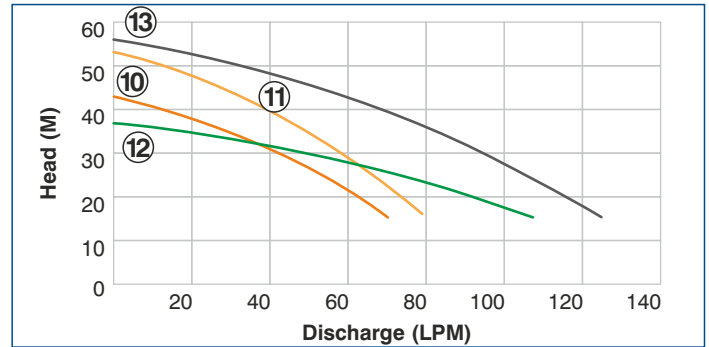
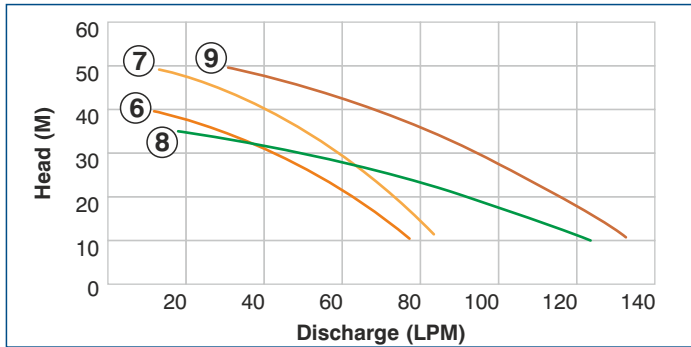
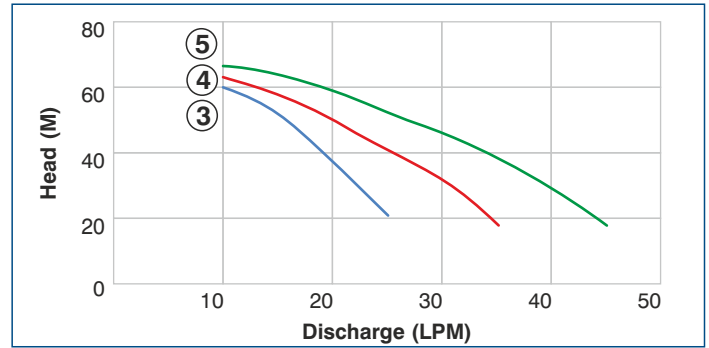
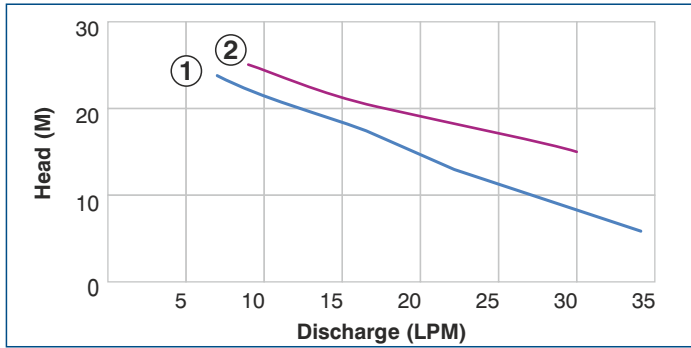

Performance Table:

| Sr. No. | Rating | Motor | | Pipe Size SucXDel mm | Recommended Pressure Settings (Bar) | Tank Size (Ltr) | Tank Pre-charge (Bar) | No. of Bathrooms recommended | Head in Meter | | | | | | |
|---------|---------------|-------|-----|----------------------|-------------------------------------|-----------------|-----------------------|------------------------------|------------------|----|----|----|----|----|----|
| | | kW | HP | | | | | | 6 | 9 | 12 | 14 | 18 | 21 | 24 |
| | | | | | | | | | Discharge in LPM | | | | | | |
| *1 | MINI FORCE II | 0.37 | 0.5 | 25 X 25 | 1.4 - 2.4 | 2 | 1.2 | 1 | 34 | 29 | 24 | 21 | 16 | 11 | 7 |

| Sr. No. | Rating | Motor | | Pipe Size SucXDel mm | No. of Bathrooms Recommended | Head in Meter | | | | |
|---------|-----------|-------|-----|----------------------|------------------------------|------------------|----|----|----|----|
| | | kW | HP | | | 15 | 18 | 20 | 22 | 25 |
| | | | | | | Discharge in LPM | | | | |
| 2 | IPSSWJ052 | 0.37 | 0.5 | 25 X 25 | 1 | 30 | 23 | 18 | 14 | 9 |

| Sr. No. | Rating | Motor | | Pipe Size SucXDel mm | Recommended Pressure Settings (Bar) | Tank Size (Ltr) | Tank Pre-charge (Bar) | No. of Bathrooms recommended | Head in Meter | | | | | | | |
|---------|------------------|-------|------|----------------------|-------------------------------------|-----------------|-----------------------|------------------------------|------------------|----|----|----|----|----|----|----|
| | | kW | HP | | | | | | 10 | 15 | 20 | 25 | 30 | 35 | 40 | 45 |
| | | | | | | | | | Discharge in LPM | | | | | | | |
| *3 | CFMSMB3D0.50-V24 | 0.37 | 0.5 | 25 X 25 | 1.5 - 2.5 | 24 | 1.3 | 2 | 60 | 52 | 37 | 21 | - | - | - | - |
| *4 | CFMSMB4D0.75-V24 | 0.55 | 0.75 | 25 X 25 | 2.0 - 3.0 | 24 | 1.3 | 3 | 63 | 58 | 50 | 41 | 32 | 18 | - | - |
| *5 | CFMSMB5D1.00-V24 | 0.75 | 1.0 | 25 X 25 | 2.5 - 4.5 | 24 | 1.3 | 3 | 67 | 64 | 59 | 52 | 46 | 38 | 29 | 18 |

| Sr. No. | Rating | Motor | | Pipe Size mm | Recommended Pressure Settings (Bar) | Tank Size (Ltr) | Tank Pre-charge (Bar) | No. of Bathrooms recommended | Head in Meter | | | | | | | | | |
|---------|------------------|-------|------|--------------|-------------------------------------|-----------------|-----------------------|------------------------------|------------------|-----|-----|-----|----|----|----|----|----|--|
| | | kW | HP | | | | | | 10 | 15 | 20 | 25 | 30 | 35 | 40 | 45 | 50 | |
| | | | | | | | | | Discharge in LPM | | | | | | | | | |
| *6 | CFCHM5D0.75B-V24 | 0.55 | 0.75 | 25 X 25 | 1.5 - 3.5 | 24 | 1.3 | 2 | 77 | 70 | 63 | 53 | 42 | 27 | 12 | - | - | |
| *7 | CFCHM6D1.0B-V24 | 0.75 | 1.0 | 25 X 25 | 2.5 - 4.5 | 24 | 2.3 | 3 | 83 | 79 | 74 | 67 | 60 | 50 | 40 | 25 | 13 | |
| *8 | CFCHM4E1.0B-V24 | 0.75 | 1.0 | 32 X 25 | 1.5 - 3.0 | 24 | 1.3 | 5 | 123 | 107 | 92 | 72 | 48 | 18 | - | - | - | |
| *9 | CFCHM6E1.5B-V24 | 1.1 | 1.5 | 32 X 25 | 2.5 - 4.5 | 24 | 2.3 | 6 | 132 | 125 | 117 | 105 | 96 | 82 | 65 | 50 | 31 | |

| Sr. No. | Rating | Motor | | Pipe Size mm | No. of Bathrooms recommended | Head in Meter | | | | | | | | | | | |
|---------|-------------------|-------|------|--------------|------------------------------|------------------|-----|-----|----|----|----|----|----|----|----|----|----|
| | | kW | HP | | | 15 | 20 | 25 | 30 | 35 | 37 | 40 | 43 | 45 | 50 | 50 | 56 |
| | | | | | | Discharge in LPM | | | | | | | | | | | |
| 10 | IPCHM5D0.75(1PH)B | 0.55 | 0.75 | 25 X 25 | 2 | 70 | 63 | 53 | 42 | 27 | 22 | 12 | 0 | - | - | - | - |
| 11 | IPCHM6D1.0(1PH)B | 0.75 | 1.0 | 25 X 25 | 3 | 79 | 74 | 67 | 60 | 50 | 46 | 40 | 31 | 25 | 13 | 0 | - |
| 12 | IPCHM4E1.0(1PH)B | 0.75 | 1.0 | 32 X 25 | 5 | 107 | 92 | 72 | 48 | 18 | 0 | - | - | - | - | - | - |
| 13 | IPCHM6E1.5(1PH)B | 1.1 | 1.5 | 32 X 25 | 6 | 125 | 117 | 105 | 96 | 82 | 80 | 65 | 60 | 50 | 31 | 18 | 0 |

Note :

1. The motor ratings in HP are only indicative and for reference purpose
2. Performance figures given above are approximate and may differ on site conditions

3. Performance mentioned on nameplate may vary as we are always improving our products
4. * Tank precharge air pressure should be 0.2 bar less than cut in pressure
5. Number of bathrooms recommended calculated by considering general bathroom fitting and losses

Material of Construction:

| No. | Part | Material |
|-----|---|-------------------------------|
| 1 | Impeller-CFMSMB, IPSSWJ | Noryl |
| 2 | Impeller-CFCHM, IPCHM | Stainless Steel- Grade SS304 |
| 3 | Impeller-MINI FORCE II | Forged Brass |
| 4 | Adaptor- MINI FORCE II, IPSSWJ | Cast Iron-IS210 Grade FG 200 |
| 5 | Diffuser-CFMSMB, IPSSWJ | Noryl |
| 6 | Diffuser Bowl-CFCHM, IPCHM | Stainless Steel- Grade SS304 |
| 7 | Volute-MINI FORCE II | Cast Iron-IS210 Grade FG 200 |
| 8 | Motor Body -IPSSWJ, CFMSMB, CFCHM, IPCHM Series | Aluminium Extruded- Grade HE9 |
| 9 | Motor Body- MINI FORCE II | Aluminium PDC- Grade ADC12 |
| 10 | Shaft- CFCHM, IPCHM | Stainless Steel- Grade SS431 |
| 11 | Shaft | Stainless Steel-Grade SS410 |
| 12 | Inserts-MINI FORCE II | Stainless Steel-Grade SS304 |
| 13 | Stamping Material | CRNGO M47 |
| 14 | End Cover - IPSSWJ | Aluminium PDC- Grade ADC12 |
| 15 | End Cover - IPSSWJ | Cast Iron-IS210 Grade FG 200 |
| 16 | Delivery Casing-CFMSMB, CFCHM, IPCHM" | Cast Iron-IS210 Grade FG 200 |
| 17 | Front Suction Sasing-IPSSWJ | Cast Iron-IS210 Grade FG 200 |
| 18 | Outer casing-CFMSMB, IPSSWJ | Stainless Steel-Grade SS304 |
| 19 | Y Stainer | Brass |
| 20 | Nozzle And Ventury- IPSSWJ | Noryl |
| 21 | Priming Plug-IPSSWJ, MINI FORCE II | Brass |
| 22 | Outlet Flanges | Cast Iron-IS210 Grade FG 200 |
| 23 | Universal Connector IPSSWJ | Engineering Plastic |
| 24 | Fan & Fan Cover-CFMSMB, MINI FORCE II | PPCP |
| 25 | Fan-CFCHM & IPCHM series | NYLON 6 |
| 26 | Fan Cover-IPCHM & CFCHMseries | PP GF 30% |

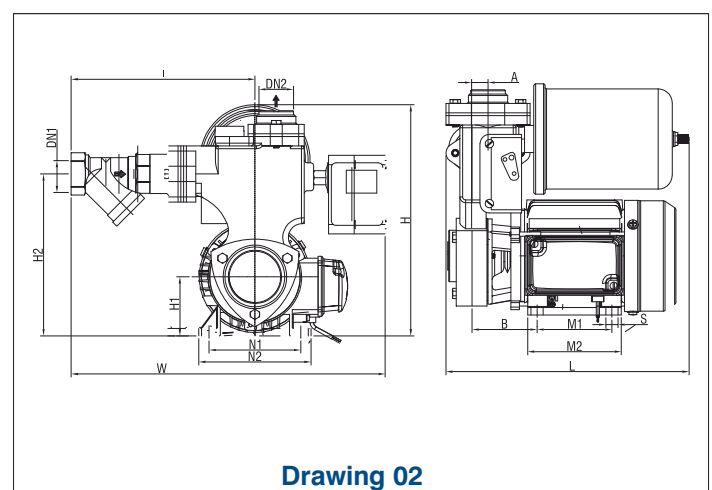
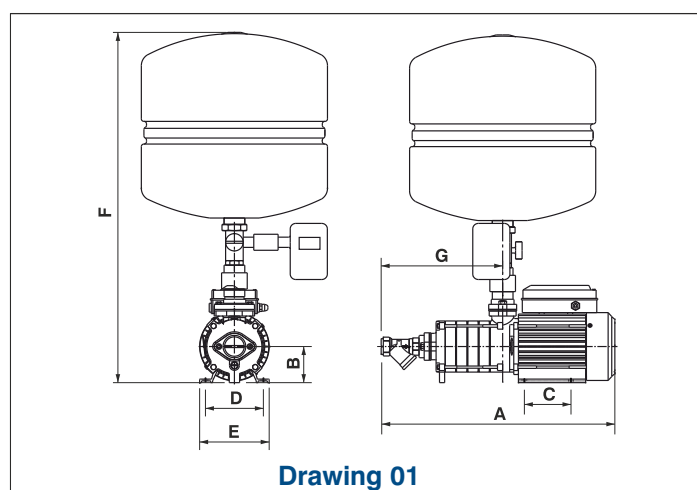
Pump Dimensional Details:

Pump Dimensional Details:

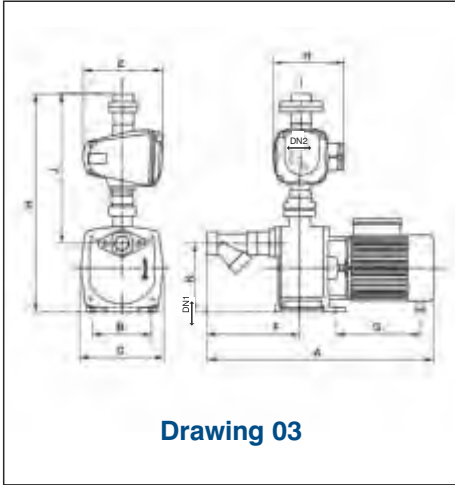

Drawing 03

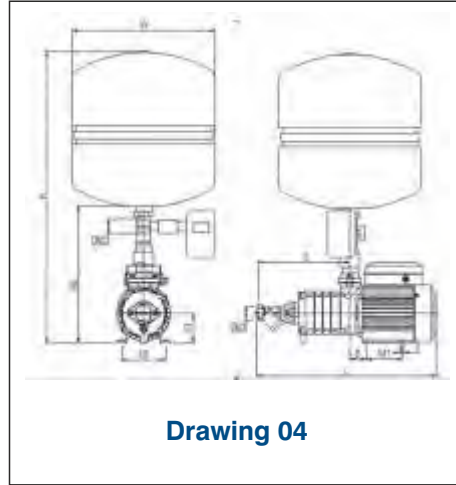

Drawing 04

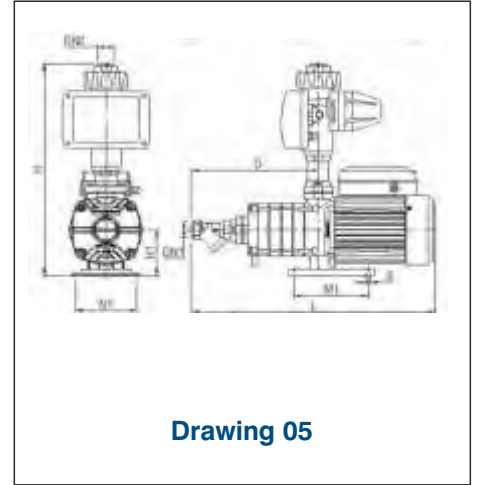

Drawing 05

Pump Dimensional Details:

| Sr. No. | MODEL | kW | HP | Refer Drawing 01 | | | | | | | | | | DN1 | DN2 |
|---------|------------------|------|------|--------------------------|----|----|-----|-----|-----|-----|-----|----|----|-----|-----|
| | | | | All Dimensions are in mm | | | | | | | | | | | |
| | | | | A | B | C | D | E | F | G | H | | | | |
| 1 | CFMSMB3D0.50-V24 | 0.37 | 0.50 | 441 | 71 | 90 | 112 | 135 | 660 | 234 | 280 | 25 | 25 | | |
| 2 | CFMSMB4D0.75-V24 | 0.55 | 0.75 | 468 | 71 | 90 | 112 | 135 | 660 | 256 | 280 | 25 | 25 | | |
| 3 | CFMSMB5D1.00-V24 | 0.75 | 1.00 | 505 | 71 | 90 | 112 | 135 | 660 | 278 | 280 | 25 | 25 | | |

| Sr. No. | MODEL | kW | HP | Refer Drawing 02 | | | | | | | | | | | | | | |
|---------|---------------|------|-----|--------------------------|-----|-----|----|-----|----|-----|-----|-----|-----|----|----|----|-----|-----|
| | | | | All Dimensions are in mm | | | | | | | | | | | | | | |
| | | | | L | W | H | H1 | H2 | M1 | M2 | N1 | N2 | I | S | A | B | DN1 | DN2 |
| 4 | MINI FORCE II | 0.37 | 0.5 | 250 | 350 | 260 | 63 | 160 | 80 | 100 | 100 | 120 | 105 | 10 | 45 | 67 | 25 | 25 |

| Sr. No. | MODEL | kW | HP | Refer Drawing 03 | | | | | | | | | | DN1 | DN2 |
|---------|-----------|------|-----|--------------------------|-----|-----|-----|-----|-----|-----|-----|-----|-----|-----|-----|
| | | | | All Dimensions are in mm | | | | | | | | | | | |
| | | | | A | B | C | D | E | F | G | H | J | K | | |
| 5 | IPSSWJ052 | 0.37 | 0.5 | 418 | 110 | 140 | 132 | 153 | 160 | 135 | 406 | 277 | 121 | 25 | 25 |

| Sr. No. | MODEL | kW | HP | Refer Drawing 04 | | | | | | | | | | | DN1 | DN2 |
|---------|------------------|------|------|--------------------------|-----|-----|------|-----|-----|-----|----|-----|-----|----|-----|-----|
| | | | | All Dimensions are in mm | | | | | | | | | | | | |
| | | | | L | W | H | H1 | H2 | M1 | N1 | B | D | S | | | |
| 6 | CFCHM5D0.75B-V24 | 0.55 | 0.75 | 407 | 280 | 680 | 88.5 | 320 | 138 | 107 | 42 | 230 | 8.5 | 25 | 25 | |
| 7 | CFCHM6D1.0B-V24 | 0.75 | 1.0 | 435 | 280 | 680 | 88.5 | 320 | 138 | 107 | 42 | 248 | 8.5 | 25 | 25 | |
| 8 | CFCHM4E1.0B-V24 | 0.75 | 1.0 | 425 | 280 | 680 | 88.5 | 320 | 138 | 107 | 42 | 238 | 8.5 | 32 | 25 | |
| 9 | CFCHM6E1.5B-V24 | 1.1 | 1.5 | 495 | 280 | 686 | 95 | 326 | 138 | 107 | 42 | 292 | 8.5 | 32 | 25 | |

| Sr. No. | MODEL | kW | HP | Refer Drawing 05 | | | | | | | | DN1 | DN2 |
|---------|-------------------|------|------|--------------------------|-----|------|-----|-----|-----|---|----|-----|-----|
| | | | | All Dimensions are in mm | | | | | | | | | |
| | | | | L | H | H1 | M1 | N1 | D | S | | | |
| 1 | IPCHM5D0.75(1PH)B | 0.55 | 0.7 | 407 | 385 | 88.5 | 138 | 107 | 230 | 9 | 25 | 25 | |
| 2 | IPCHM6D1.0(1PH)B | 0.75 | 1.0 | 435 | 385 | 88.5 | 138 | 107 | 248 | 9 | 25 | 25 | |
| 3 | IPCHM4E1.0(1PH)B | 0.75 | 1.0 | 425 | 385 | 88.5 | 138 | 107 | 238 | 9 | 32 | 25 | |
| 4 | IPCHM6E1.5(1PH)B | 1.10 | 1.50 | 495 | 391 | 95 | 138 | 107 | 292 | 9 | 32 | 25 | |

Horizontal Multistage Pumps (CHM & MSMB Series)

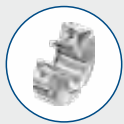

*Cartridge type mechanical seal

Carbon/SiC/Viton suitable for Hot water
(Suitable up to 1200 C temp)



*Stainless steel construction

Pump parts -for corrosion resistance



Top Fitted

Motor fitted with Thermal Overload Protector
(TOP)



High Operating Efficiency

Higher efficiency results in higher performance &
lower electricity consumption.



Easy for Maintenance

Easily replaceable wear & tear Parts

Technical Specifications:

- Range: 1 Phase – 0.5 HP to 1.5 HP
(0.37 kW to 1.1 kW)
- Rated Voltage: 220V
- Voltage Range: 180V-260V
- Rated Frequency: 50Hz
- Pipe Size: 25mm x 25mm, 32mm x 25mm
- Max. head: CHM- up to 49M
MSMB- Up to 47M
- Max. Discharge : CHM- up to 7M³/Hr
MSMB- Up to 4200LPH
- Liquid: Clear & Cold Water
- Rotation: Clockwise as viewed from Motor End

Application:

- Domestic Water Boosters
- Sprinkler
- Raw Water Feed pump in RO
- Water Treatment Plants
- Seawater Pumping
- Chemical / Processing
- Food Processing
- Boiler Feeding

Performance Curve:

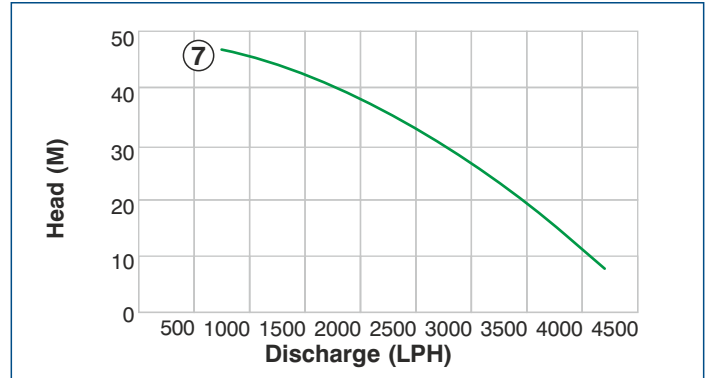
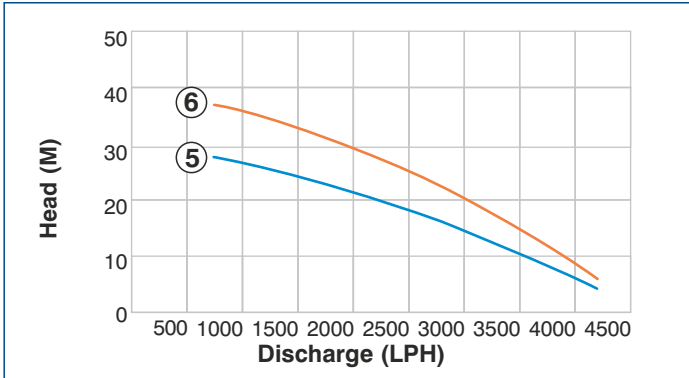
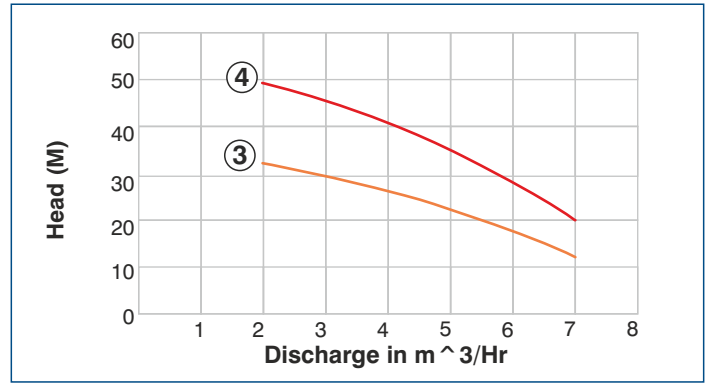
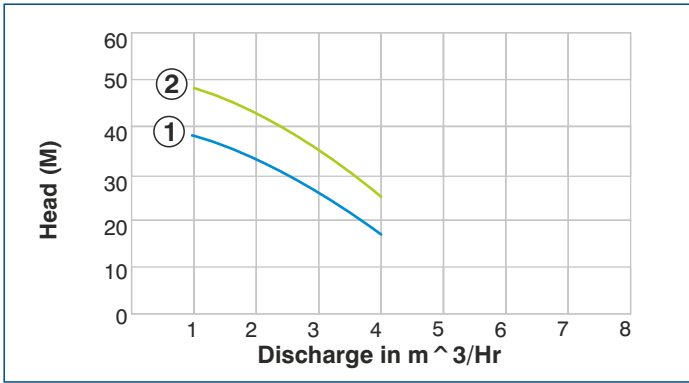

Performance Table:

| Sr. No. | Rating | Motor | | Pipe Size (mm) | Discharge in m ³ /Hr | | | | | | |
|---------|--------------------|-------|------|----------------|---------------------------------|----|----|----|----|----|----|
| | | kW | HP | | 1 | 2 | 3 | 4 | 5 | 6 | 7 |
| | | | | | Head in Meter | | | | | | |
| 1 | CHM5D0.75(1PH)B-38 | 0.55 | 0.75 | 25 X 25 | 38 | 33 | 26 | 17 | - | - | - |
| 2 | CHM6D1.0(1PH)B-48 | 0.75 | 1 | 25 X 25 | 48 | 43 | 35 | 25 | - | - | - |
| 3 | CHM4E1.0(1PH)B-32 | 0.75 | 1 | 32 X 25 | - | 32 | 30 | 26 | 22 | 18 | 12 |
| 4 | CHM6E1.5(1PH)B-49 | 1.1 | 1.5 | 32 X 25 | - | 49 | 46 | 40 | 35 | 28 | 20 |

| Sr. No. | Rating | Motor | | Pipe Size (mm) | Discharge in LPH | | | | | |
|---------|------------|-------|------|----------------|------------------|------|------|------|------|------|
| | | kW | HP | | 750 | 1400 | 2100 | 2800 | 3500 | 4200 |
| | | | | | Head in Meter | | | | | |
| 5 | MSMB3D0.50 | 0.37 | 0.5 | 25 X 25 | 28 | 24 | 21 | 16 | 11 | 4 |
| 6 | MSMB4D0.75 | 0.55 | 0.75 | 25 X 25 | 37 | 33 | 29 | 22 | 15 | 6 |
| 7 | MSMB5D1.00 | 0.75 | 1 | 25 X 25 | 47 | 43 | 36 | 29 | 21 | 7 |

Note:

- The motor ratings in HP are only indicative and for reference purpose
- Performance figures given above are approximate and may differ on site conditions
- Performance mentioned on nameplate may vary as we are always improving our products
- *For CHM model Note- With SS insert & Cartridge type mechanical seal

Material of Construction:

| Sr. No. | Part | Material |
|---------|----------------------|--|
| 1 | Impeller-MSMB | Noryl |
| 2 | Impeller-CHM | Stainless Steel-SS304 |
| 3 | Diffuser-MSMB | Noryl |
| 4 | Diffuser bowl-CHM | Stainless Steel-SS304 |
| 5 | Motor Body | Aluminium Extruded-HE9 Grade |
| 6 | Shaft | Stainless Steel-SS410 |
| 7 | Stamping Material | CRNGO M47 |
| 8 | End Shield | Aluminium ADC12 |
| 9 | Delivery Casing | Cast Iron-IS210 Grade FG 200 |
| 10 | Outer casing-MSMB | Stainless Steel-SS304 |
| 11 | Fan-MSMB | PPCP |
| 12 | Fan Cover-MSMB | PPCP |
| 13 | Fan-CHM | NYLON 6 |
| 14 | Fan Cover-CHM | PP GF 30% |
| 15 | Mechanical Seal-CHM | Tungsten Carbide Vs Sintered carbon + Viton Rubber (FKM) |
| 16 | Mechanical Seal-MSMB | Ceramic Vs Graphite |

Pump Dimensional Details:

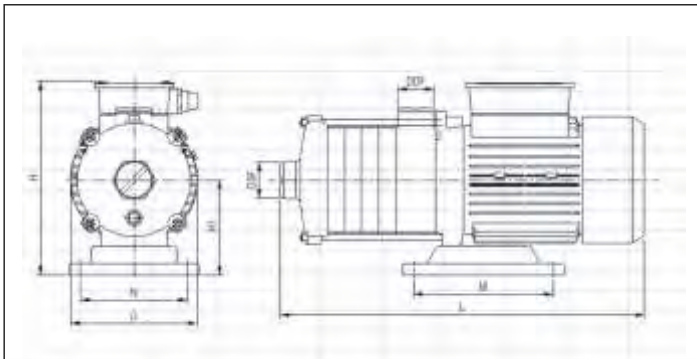

Drawing 1 - CHM

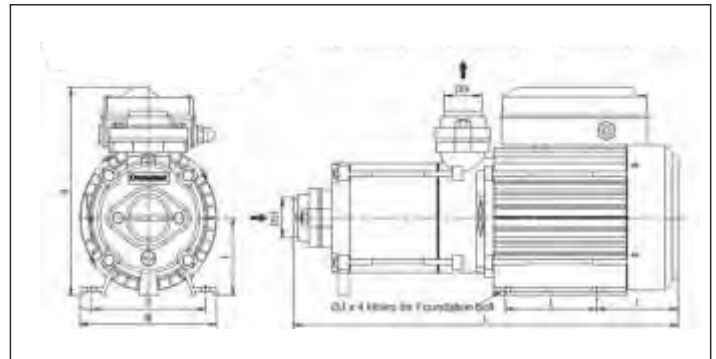

Drawing 2 - MSMB

Drawing 1 - CHM

| Sr. No. | Model | Power | | Pipe Size (mm) | No. of STAGES | All Dimensions are in mm | | | | | |
|---------|--------------------|-------|------|----------------|---------------|--------------------------|-----|------|-----|-----|-----|
| | | kW | HP | | | C | H | H1 | L | M | N |
| | | | | | | Head in Meter | | | | | |
| 1 | CHM5D0.75(1PH)B-38 | 0.55 | 0.75 | 25 X 25 | 5 | 135 | 207 | 88.5 | 407 | 138 | 107 |
| 2 | CHM6D1.0(1PH)B-48 | 0.75 | 1 | 25 X 25 | 6 | 135 | 207 | 88.5 | 435 | 138 | 107 |
| 3 | CHM4E1.0(1PH)B-32 | 0.75 | 1 | 32 X 25 | 4 | 135 | 207 | 88.5 | 425 | 138 | 107 |
| 4 | CHM6E1.5(1PH)B-49 | 1.1 | 1.5 | 32 X 25 | 6 | 162 | 260 | 95 | 495 | 146 | 112 |

Drawing 2 - MSMB

| Sr. No. | Model | Power | | Pipe Size (mm) | All Dimensions are in mm | | | | | | | | | | |
|---------|------------|-------|------|----------------|--------------------------|-----|-----|----|-----|----|-----|-----|---|-----|-----|
| | | kW | HP | | L | W | H | F | H2 | E | F | D | J | DSF | DNF |
| | | | | | Head in Meter | | | | | | | | | | |
| 5 | MSMB3D0.50 | 0.37 | 0.50 | 25 X 25 | 352 | 135 | 191 | 71 | 300 | 90 | 125 | 112 | 9 | 25 | 25 |
| 6 | MSMB4D0.75 | 0.55 | 0.75 | 25 X 25 | 379 | 135 | 191 | 71 | 300 | 90 | 125 | 112 | 9 | 25 | 25 |
| 7 | MSMB5D1.00 | 0.75 | 1.00 | 32 X 25 | 416 | 135 | 191 | 71 | 300 | 90 | 125 | 112 | 9 | 25 | 25 |

Sewage Submersible Pumps (STPM, STPC & CCP Series)



STP



STPC



CSP



CCP



Overload Protection

Single phase pumps are fitted with thermal overload protector (TOP)



High Grade Electrical Stamping

Reduces electrical losses & improves pump efficiency



Dry run protection*

In 1PH model float switch provided for dry run protection.



Double mechanical seal

Offers more sturdy and durable

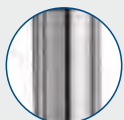

Anti-Rust CED Coating*

Offers rust free & stuck free operation



Solid handling capacity:

Up to 35MM, applicable to STPM series



Easy for Maintenance

Easily replaceable wear & tear Parts

Technical Specifications: STPM & STPG Series

- Range: Up to 5.5Kw/7.5HP
- Rated Voltage: 220V
- Voltage Range: 160-260V
- Rated Frequency: 50Hz
- Pipe size: 50 & 100mm
- Max. Head: Up to 22m
- Max. Discharge: Up to 1500 LPM

Technical Specifications: CCP Series

- Range: 1.0 HP (1PH)
- Rated Voltage: 220V
- Voltage Range: 160-260V
- Rated Frequency: 50Hz
- Pipe size: 50 mm
- Max. Head: Up to 10M
- Max. Discharge: Up to 260LPM

Application:

- Construction Sites
- Hotels and restaurants
- Sewage treatment plants
- Wastewater treatment plants

Performance Curve:

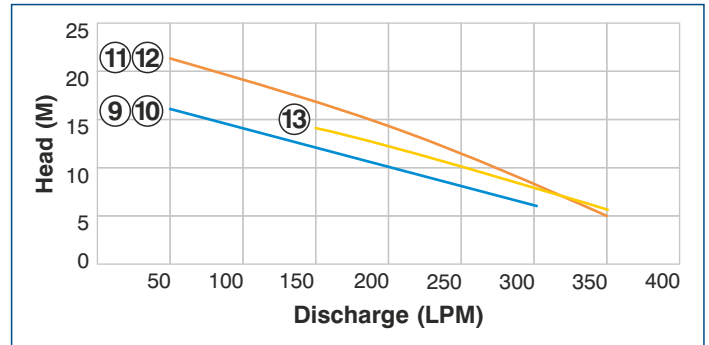
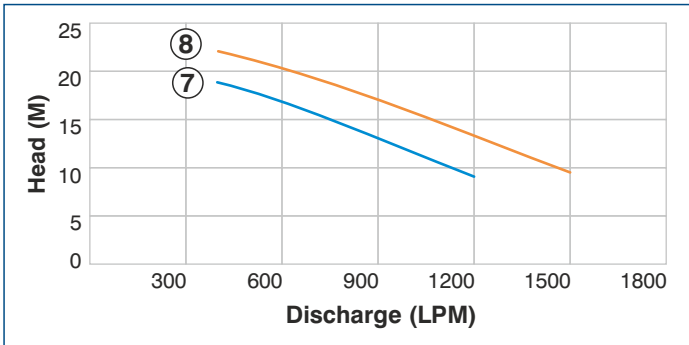
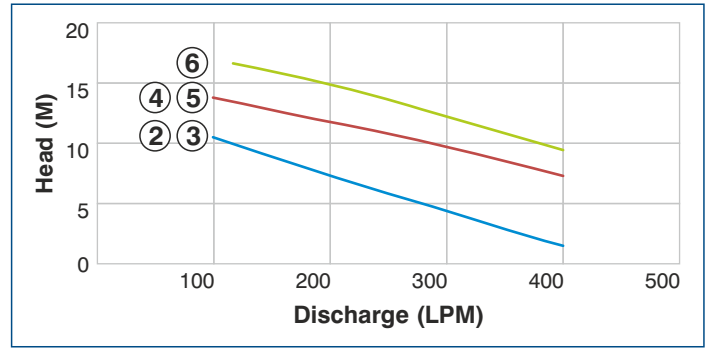
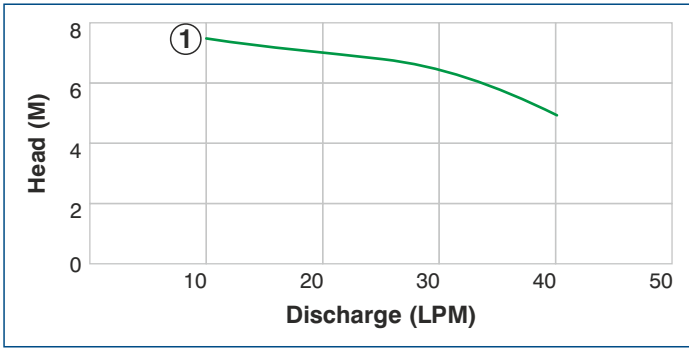

Performance Table:

| Sr. No. | Rating | Motor | | Pipe Size mm | Max. Solid Size (mm) | Head in Meter | | | |
|---------|----------------|-------|-----|--------------|----------------------|------------------|----|-----|-----|
| | | kW | HP | | | 30 | 60 | 90 | 130 |
| | | | | | | Discharge in LPM | | | |
| 1 | STPG052(1PH)-7 | 0.37 | 0.5 | 32 | 20 | 7.5 | 7 | 6.5 | 6 |

| Sr. No. | Rating | Motor | | Pipe Size mm | Max. Solid Size (mm) | Head in Meter | | | |
|---------|----------------|-------|-----|--------------|----------------------|------------------|-----|------|-----|
| | | kW | HP | | | 100 | 200 | 300 | 400 |
| | | | | | | Discharge in LPM | | | |
| 2 | STPM12(1PH)-10 | 0.75 | 1.0 | 50 | 35 | 10.8 | 7.3 | 5 | 1.8 |
| 3 | STPM12-10 | 0.75 | 1.0 | 50 | 35 | 10.8 | 7.3 | 5 | 1.8 |
| 4 | STPM22(1PH)-14 | 1.5 | 2.0 | 50 | 35 | 14 | 12 | 10 | 7.6 |
| 5 | STPM22-14 | 1.5 | 2.0 | 50 | 35 | 14 | 12 | 10 | 7.6 |
| 6 | STPM32-17 | 2.2 | 3.0 | 50 | 35 | 17 | 15 | 12.5 | 9.6 |

| Sr. No. | Rating | Motor | | Pipe Size mm | Max. Solid Size (mm) | Head in Meter | | | | | | | | |
|---------|--------------|-------|-----|--------------|----------------------|------------------|------|------|------|-----|------|------|------|------|
| | | kW | HP | | | 400 | 500 | 600 | 800 | 900 | 1100 | 1200 | 1400 | 1500 |
| | | | | | | Discharge in LPM | | | | | | | | |
| 7 | STPCS5.52-18 | 4.0 | 5.5 | 100 | 30 | 18.5 | 17 | 16 | 15.5 | 13 | 11 | 9 | - | - |
| 8 | STPCS7.52-22 | 5.5 | 7.5 | 100 | 30 | 22 | 21.5 | 20.5 | 18 | 17 | 15 | 13 | 11.5 | 9.5 |

| Sr. No. | Rating | Motor | | Pipe Size mm | Max. Solid Size (mm) | Head in Meter | | | | | |
|---------|----------------|-------|-----|--------------|----------------------|------------------|-----|-----|-----|-----|-----|
| | | kW | HP | | | 50 | 100 | 150 | 250 | 300 | 350 |
| | | | | | | Discharge in LPM | | | | | |
| 9 | CCPM12(1PH)-16 | 0.75 | 1.0 | 50 | 16 | 14 | 12 | 8 | 6 | | |
| 10 | CCPM12-16 | 0.75 | 1.0 | 50 | 16 | 14 | 12 | 8 | 6 | | |
| 11 | CCPM22(1PH)-21 | 1.5 | 2.0 | 50 | 21 | 19 | 17 | 11 | 8 | 5 | |
| 12 | CCPM22-21 | 1.5 | 2.0 | 50 | 21 | 19 | 17 | 11 | 8 | 5 | |
| 13 | CCPM32-14 | 2.2 | 3.0 | 50 | - | - | 14 | 13 | 12 | 11 | |

Note:

1. The motor ratings in HP are only indicative and for reference purpose
2. Performance figures given above are approximate and may differ on site conditions

3. Performance mentioned on nameplate may vary as we are always improving our products

Material of Construction:

| STPM & STPC SERIES | | |
|--------------------|---|--------------------------------|
| Components | STPM | STPC |
| Cable | Poly Vinyl Chloride (PVC) | Poly Vinyl Chloride (PVC) |
| Cable Hood | Nitrile Butadiene Rubber | Stainless Steel (AISI 410) |
| Handle | Stainless Steel (AISI 410) | Not Applicable STP Series |
| Motor Cover | Cast Iron | Cast Iron |
| Seal Housing | Cast Iron | Cast Iron |
| Bracket | NA | Cast Iron |
| Oil Chamber | Cast Iron | Cast Iron |
| Pump Casing | Cast Iron | Cast Iron |
| Impeller | Cast Iron | Cast Iron |
| Oil Seal | Nitrile Butadiene Rubber | Nitrile Butadiene Rubber |
| Shaft | Stainless Steel (AISI 410) | Stainless Steel (AISI 410) |
| Motor Housing | SS304 | Cast Iron |
| Tie Rods | SS304 | Not Applicable |
| Mechanical Seal | Double Mechanical Seal (SiC + Carbon-Ceramic) | Double Mechanical Seal (SiC +) |

| CCPM SERIES | |
|-----------------|----------------------------|
| Components | CCP |
| Cable | Poly Vinyl Chloride (PVC) |
| Cable Hood | Nitrile Butadiene Rubber |
| Handle | Stainless Steel (AISI 410) |
| Motor Cover | Cast Iron |
| Seal Housing | Cast Iron |
| Bracket | Not Applicable |
| Oil Chamber | Cast Iron |
| Pump Casing | Cast Iron |
| Impeller | Cast Iron |
| Oil Seal | Nitrile Butadiene Rubber |
| Shaft | Stainless Steel (AISI 410) |
| Motor Housing | SS304 |
| Tie Rods | SS304 |
| Mechanical Seal | Double Mechanical Seal |
| Cutter | High Chromium Steel |

Pump Dimensional Details:

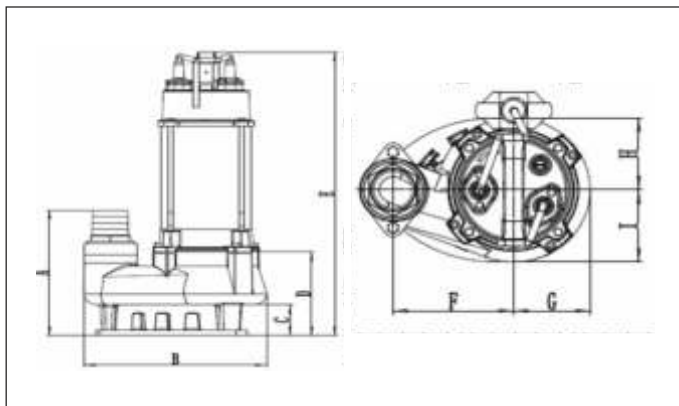

Drawing 1

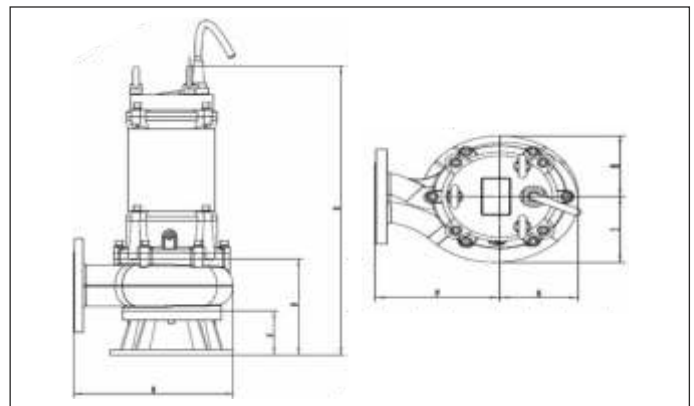

Drawing 2

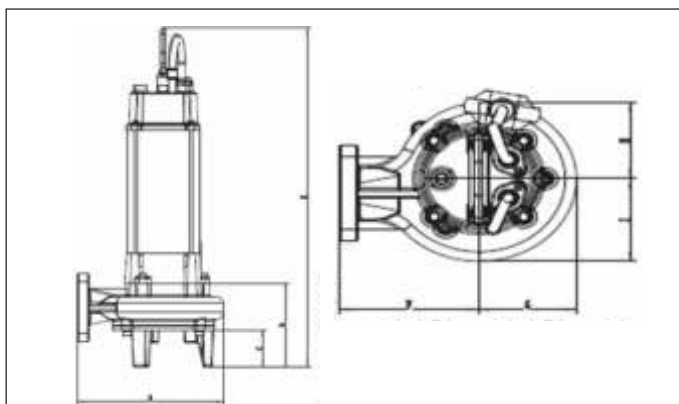

Drawing 3

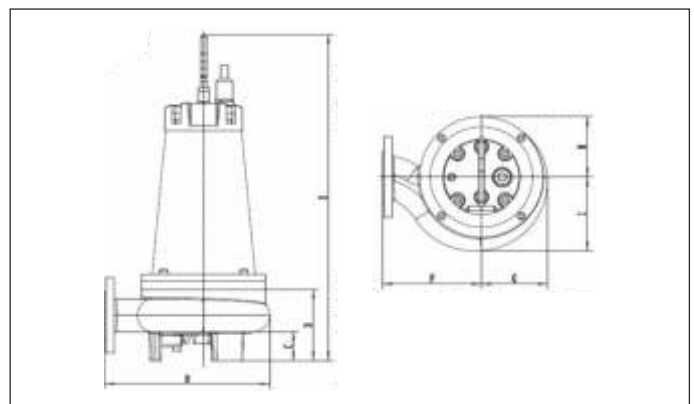

Drawing 4

| Drawing 1 | | | | | | | | | |
|----------------|-----------------|-----|----|-----|-----|-----|----|----|----|
| Model Name | Dimensions (mm) | | | | | | | | |
| | A | B | C | D | E | F | G | H | I |
| STPM12(1PH)-10 | 245 | 249 | 55 | 152 | 466 | 130 | 83 | 83 | 83 |
| STPM12-10 | 245 | 249 | 55 | 152 | 466 | 130 | 83 | 83 | 83 |
| STPM22(1PH)-14 | 245 | 249 | 55 | 152 | 506 | 130 | 83 | 83 | 83 |
| STPM22-14 | 245 | 249 | 55 | 152 | 506 | 130 | 83 | 83 | 83 |
| STPM32-17 | 245 | 249 | 55 | 152 | 526 | 130 | 83 | 83 | 83 |
| STPG052(1PH)-7 | 140 | 170 | 27 | 99 | 340 | 85 | 60 | 60 | 60 |

| Drawing 2 | | | | | | | | | |
|--------------|-----------------|----|-----|-----|-----|-----|-----|-----|--|
| Model Name | Dimensions (mm) | | | | | | | | |
| | B | C | D | E | F | G | H | I | |
| STPCS5.52-18 | 323 | 99 | 230 | 650 | 207 | 125 | 125 | 142 | |
| STPCS7.52-22 | 323 | 99 | 230 | 650 | 207 | 125 | 125 | 142 | |

| Drawing 3 | | | | | | | | | |
|----------------|-----------------|----|-----|-----|-----|-----|----|-----|--|
| Model Name | Dimensions (mm) | | | | | | | | |
| | B | C | D | E | F | G | H | I | |
| CCPM12(1PH)-16 | 254 | 58 | 140 | 595 | 152 | 102 | 97 | 106 | |
| CCPM12-16 | 254 | 58 | 140 | 595 | 152 | 102 | 97 | 106 | |
| CCPM22(1PH)-21 | 254 | 58 | 140 | 595 | 152 | 102 | 97 | 106 | |
| CCPM22-21 | 254 | 58 | 140 | 595 | 152 | 102 | 97 | 106 | |

| Drawing 4 | | | | | | | | | |
|------------|-----------------|----|-----|-----|-----|-----|-----|-----|--|
| Model Name | Dimensions (mm) | | | | | | | | |
| | B | C | D | E | F | G | H | I | |
| CCPM32-14 | 276 | 55 | 132 | 610 | 167 | 109 | 105 | 116 | |

Circulating Inline Pumps (CIL Series)



Automatic Operation

As per water requirement, pump automatically stops when we close tap and starts when we open tap



Hot Water Application

Can handle water up to 90° C



Noiseless Operation

Pump noise less than 55db



Mode Selection

Pump can be easily switched to Manual mode, Automatic mode and Off mode by using switch as per requirement

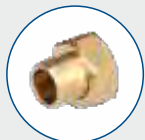

Brass Suction and Delivery Connector

Provided with pump for easy connection



Speed Selection Provision*

Three speeds provided to set required performance

Technical Specifications:

- Range: Upto 0.47/0.35 HP/kW
- Rated voltage: 220V
- Voltage range: 160-260V
- Rated Frequency: 50Hz
- Pipe size: Upto 20 mm
- Max. Head: Upto 15 meter
- Max. Discharge: Upto 55 LPM

Application:

- Bathrooms
- Washing machine
- Besin
- Geyser
- Toilets
- Water heater

Assembly:

CIL120-9

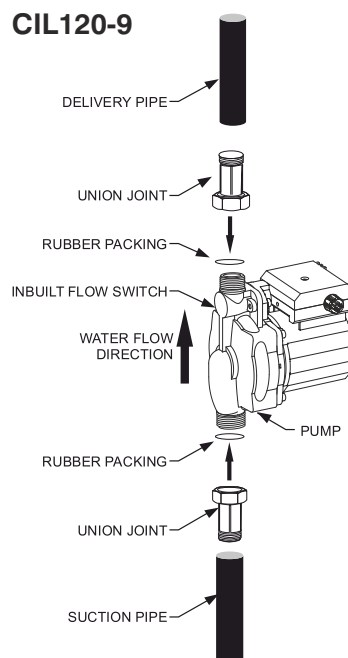

CIL350-15

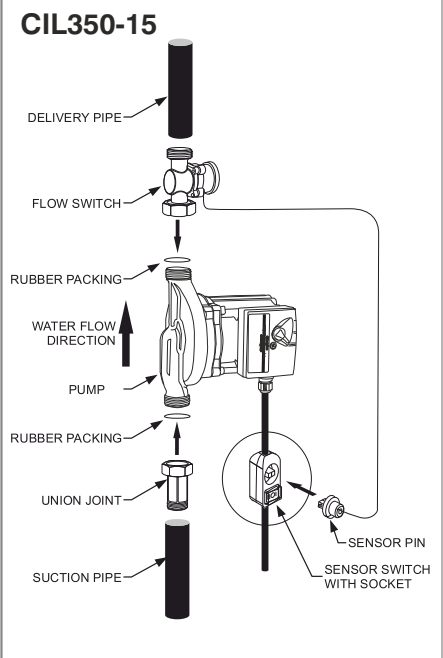

Performance Curve:

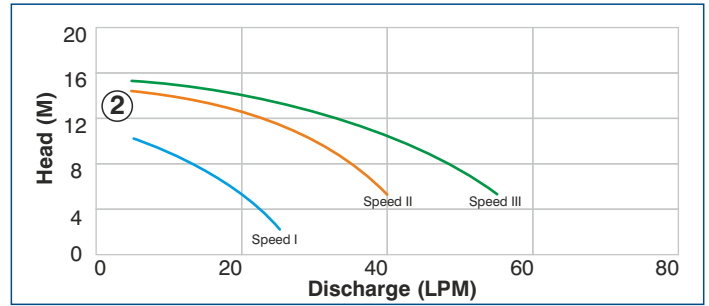
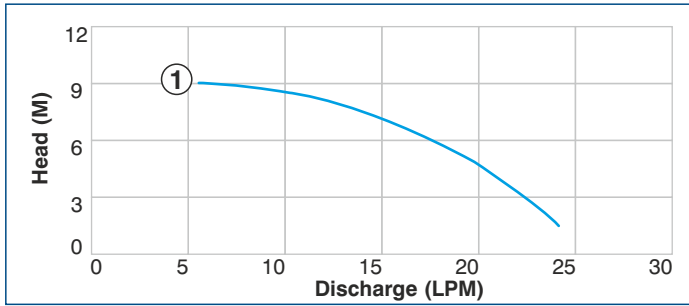

Performance Table:

| Sr. No. | Catref | Power | | Supply Phase | Pipe Size mm | Speed | Flow (LPM) | | | | | | |
|---------|----------|-------|------|--------------|--------------|-------|---------------|---|----|----|----|----|----|
| | | kW | HP | | | | 6 | 9 | 12 | 15 | 18 | 21 | 24 |
| | | | | | | | Head in Meter | | | | | | |
| 1 | CIL120-9 | 0.12 | 0.16 | 1 PH | 13 X 13 | - | 9 | 8 | 7 | 6 | 5 | 4 | 2 |

| Sr. No. | Catref | Power | | Supply Phase | Pipe Size mm | Speed | Flow (LPM) | | | | | | | | | |
|---------|-----------|-------|------|--------------|--------------|-------|---------------|----|----|----|----|----|----|----|----|----|
| | | kW | HP | | | | 5 | 10 | 15 | 20 | 25 | 30 | 35 | 40 | 50 | 55 |
| | | | | | | | Head in Meter | | | | | | | | | |
| *2 | CIL350-15 | 0.35 | 0.47 | 1 PH | 20 X 20 | I | 10 | 9 | 7 | 5 | 2 | - | - | - | - | - |
| | | | | | | II | 14 | 13 | 12 | 11 | 10 | 8 | 7 | 5 | - | - |
| | | | | | | III | 15 | 15 | 14 | 13 | 12 | 11 | 10 | 9 | 7 | 5 |

Note :

- The motor ratings in HP are only indicative and for reference purpose
- Performance figures given above are approximate and may differ on site conditions
- Performance mentioned on nameplate may vary as we are always improving our products
- *Speed selector provided for CIL350-15 model

Installation:

- Positive pressure required at inlet of pump
- Pump should be installed such that motor shaft always remain horizontal

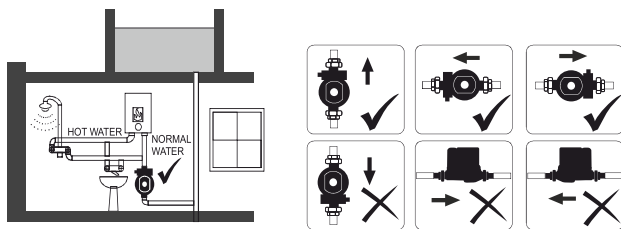

Material of Construction:

| No. | Part | Material |
|-----|-------------------|------------------------|
| 1 | Impeller | Polyether sulfone G30 |
| 2 | Volute | Cast Iron Grade FG 200 |
| 3 | Sealing Rings | EPDM Rubber |
| 4 | O-Ring | EPDM Rubber |
| 5 | In/Out Connectors | Brass |
| 6 | Motor Shaft | Ceramic |
| 7 | Thrust Bearing | Graphite |
| 8 | Radial Bearing | Ceramic |
| 9 | Motor Body | Aluminum Grade 4600A |

Pump Dimensional Details:

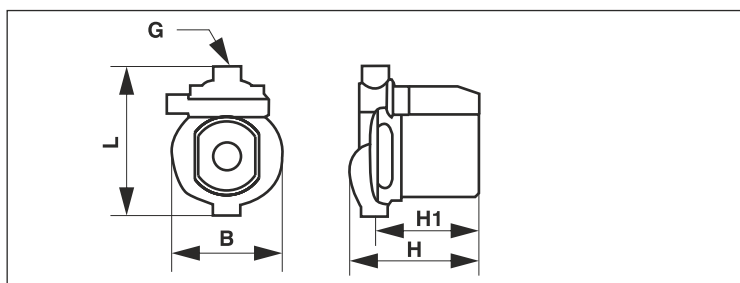

| Model Name | All Dimensions are in mm | | | | |
|------------|--------------------------|-----|-----|-----|-----|
| | H | H1 | L | G | B |
| CIL120-9 | 142 | 119 | 160 | Ø13 | 103 |
| CIL350-15 | 170 | 129 | 180 | Ø20 | 155 |

Dewatering Monobloc Pumps



Self Priming capacity

Upto 8.0 meters at Mean Sea level

Construction type

Bare pump / Monoset

Shaft Sealing options

Gland packing / Mechanical Seal

Totally Enclosed Fan Cooled Motor

Suitable for wide voltage application

Non-clog type Impeller

Can handle liquid with solid particles

Easy maintenance

With Interchangeable Parts

Technical Specifications:

- Power range: 0.75 to 18.7kW (1 to 25HP)
- Rated voltage: 415V for 3 PH
225V for 1PH
- Pipe size: 40X40 mm to 150X150 mm
- Speed: 1500 / 3000 rpm
- Rated Frequency: 50Hz
- Total Head: Up to 36m
- Capacity: Up to 4310 LPM
- Solid Handling capacity: Up to 40mm
- Motor: Degree of Protection - Ip54
- Motor: Class of Insulation - B

Application:

Industrial

- Effluent Treatment Plants
- Transfer of Petroleum products, Chemicals, Treated / Raw water
- Ash water in Thermal Power Plants
- Waste Liquid in Tiles & Marble factories

Domestic

- Civil construction sites
- Swimming pool filtration
- Dewatering of Basement water & trenches

Marine

- Pumping water from docks, ports, vessels

Agriculture

- Dewatering

Performance Curve:

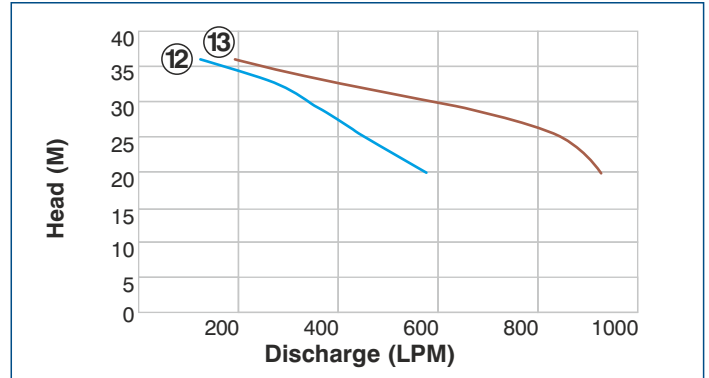
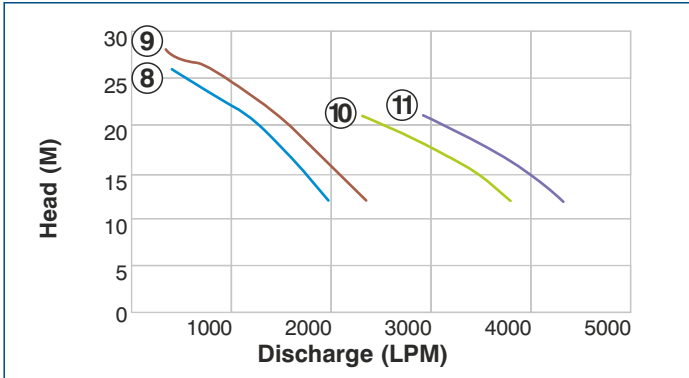
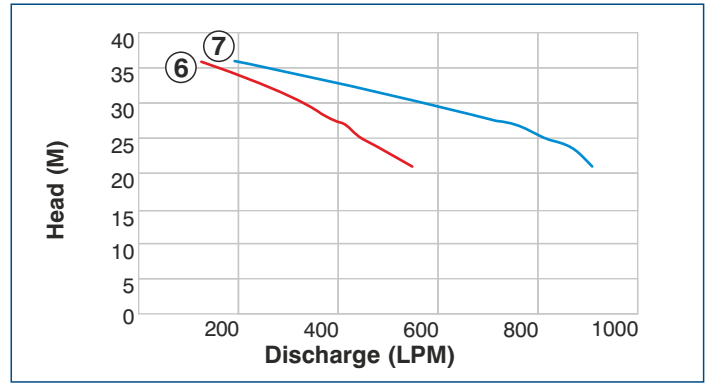
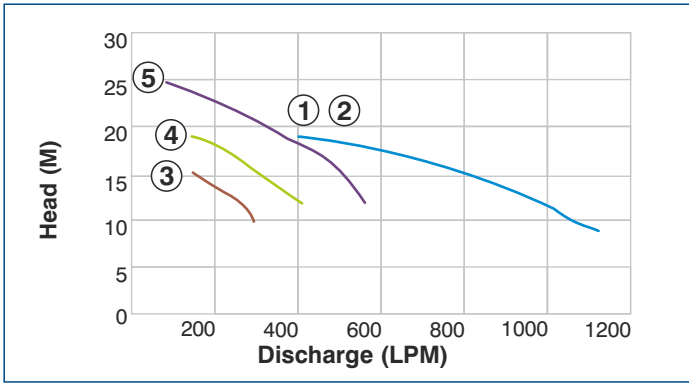

Performance Table:

| Sr. No. | Rating | No. Of Stages | Motor | | | Solid Handling Size in mm | Discharge in LPM | | | | | | | |
|---------|----------------------------|---------------|-------|-----|------|---------------------------|------------------|------|-----|-----|-----|-----|-----|----|
| | | | kW | HP | RPM | | 9 | 10 | 12 | 15 | 18 | 19 | 21 | 25 |
| | | | | | | | Head in Meter | | | | | | | |
| 1 | DWMJ12N | 40X40 | 0.75 | 1.0 | 2830 | 7.0 | - | 295 | 260 | 145 | - | - | - | - |
| 2 | DIMJ12-15 / DIMJ12(1PH)-15 | 40X40 | 0.75 | 1.0 | 2830 | 7.0 | - | 295 | 260 | 145 | - | - | - | - |
| 3 | DWMJ22 / DWMJ22-M | 40X40 | 1.5 | 2.0 | 2830 | 8.5 | - | - | 410 | 310 | 210 | 145 | - | - |
| 4 | DWMM32 / DWMM32-M | 50X50 | 2.2 | 3.0 | 2830 | 10.5 | - | - | 560 | 510 | 425 | 370 | 305 | 80 |
| 5 | DWMQ5 | 80X80 | 3.7 | 5.0 | 1430 | 15.5 | 1125 | 1060 | 985 | 800 | 550 | 400 | - | - |

| Sr. No. | Rating | No. Of Stages | Motor | | | Solid Handling Size in mm | Discharge in LPM | | | | | | | |
|---------|----------|---------------|-------|-----|------|---------------------------|------------------|-----|-----|-----|-----|-----|-----|-----|
| | | | kW | HP | RPM | | 21 | 24 | 25 | 27 | 28 | 31 | 34 | 36 |
| | | | | | | | Head in Meter | | | | | | | |
| 6 | DWMQ52 | 80X80 | 3.7 | 5.0 | 2840 | 7.0 | 550 | 480 | 450 | 415 | 380 | 305 | 205 | 125 |
| 7 | DWMQ7.52 | 80X80 | 5.5 | 7.5 | 2840 | 14.5 | 910 | 865 | 820 | 760 | 685 | 520 | 325 | 190 |

| Sr. No. | Rating | No. Of Stages | Motor | | | Solid Handling Size in mm | Discharge in LPM | | | | | | | |
|---------|----------|---------------|-------|------|------|---------------------------|------------------|------|------|------|------|------|-----|-----|
| | | | kW | HP | RPM | | 12 | 15 | 18 | 20 | 21 | 26 | 27 | 28 |
| | | | | | | | Head in Meter | | | | | | | |
| 8 | DWCS10 | 100X100 | 7.5 | 10.0 | 1460 | 18.5 | 1960 | 1730 | 1465 | 1280 | 1165 | 402 | - | - |
| 9 | DWCS12.5 | 100X100 | 9.3 | 12.5 | 1460 | 23.0 | 2340 | 2060 | 1770 | 1570 | 1475 | 805 | 480 | 340 |
| 10 | DWCV20 | 150X150 | 15 | 20.0 | 1460 | 34.0 | 3790 | 3440 | 2930 | 2530 | 2310 | 305 | - | - |
| 11 | DWCV25 | 150X150 | 18.7 | 25.0 | 1460 | 40.0 | 4310 | 3955 | 3500 | 3100 | 2910 | 1180 | - | - |

| Sr. No. | Rating | No. Of Stages | Motor | | | Solid Handling Size in mm | Discharge in LPM | | | | | | | |
|---------|----------|---------------|-------|-----|------|---------------------------|------------------|-----|-----|-----|-----|-----|-----|-----|
| | | | kW | HP | RPM | | 20 | 24 | 26 | 28 | 30 | 32 | 34 | 36 |
| | | | | | | | Head in Meter | | | | | | | |
| 12 | DWCQ52 | 80X80 | 3.7 | 5.0 | 2830 | 7.0 | 575 | 480 | 430 | 390 | 340 | 295 | 220 | 125 |
| 13 | DWCQ7.52 | 80X80 | 5.5 | 7.5 | 2830 | 14.5 | 925 | 865 | 810 | 715 | 600 | 460 | 305 | 190 |

Note :

1. The motor ratings in HP are only indicative and for reference purpose
2. Performance figures given above are approximate and may differ on site conditions

3. Performance mentioned on nameplate may vary as we are always improving our products

Material of Construction:

| Sr. No. | Part | Material |
|---------|-------------------|------------------|
| 1 | Impeller | Graded Cast Iron |
| 2 | Diffuser | Graded Cast Iron |
| 3 | Stamping material | Graded Cast Iron |
| 4 | Motor shaft | Carbon Steel |

TECHNICAL DATA

Terminology and Head Calculations

1. **Capacity (Discharge):** Rate of flow of liquid measured in litres per minute or gallons per minute.
2. **Total Head:** The standard unit for expressing head shall be the metres, thus the head in metres of liquid column = pressure in kg/cm x 10.
3. **Frictional Losses:** Resistance by inner surface of pipe and fittings through which liquid is being pumped.
4. **Cavitation:** The formation of cavities in a fluid, is a phenomenon involving the appearance and subsequent sudden collapse of vapour bubbles in a flow of fluid.
5. **Suction Lift (HS):** Is the vertical distance between pump center line and water level.
6. **Delivery Head(HD):** Vertical Distance above the pump centreline to the top most point of the delivery.
7. **N.P.S.H.:** Net Positive Suction Head. It is the pressure in terms of absolute head in meters or feet at a pump suction branch minus vapour pressure of the liquid at its working temperature. It can be simply taken as entry loss at the impeller eye in the case of centrifugal pump.
8. **Vapour Pressure:** Can be defined as that pressure which is just necessary to keep a liquid from boiling at a particular given temperature.
9. **Duty Point:** The pump is designed for one point where the maximum pump Eff. / overall Eff is achieved. This point is called Duty Point or operating Point.

10. **Pump EFF.:** The ratio of the pump output to the pump input
 Thus Pump eff. = $\frac{(T. \text{ Head} \times \text{ Discharge}) \text{ in kW}}{\text{Motor Out put in kW}} \times 100$

11. **OVERALL EFF.:** The ratio of the pump output to the motor input
 Thus Overall Eff. = Pump Efficiency x Motor Efficiency

$$\frac{\text{Pump Output}}{\text{Pump Input}} \times \frac{\text{Motor Output}}{\text{Motor Input}} = \frac{\text{Pump Output}}{\text{Motor Input}}$$

12. **Specific Gravity:** Ratio of wt of given volume of fluid compared to same wt of equal volume of water at std temp & pressure. Specific Gravity of Water is 1.0. If fluid has Specific gravity other than water (1.0) multiply brake horsepower for water by specific gravity of fluid to obtain horsepower required.

13. **Viscosity:** Property of Internal Friction of a fluid or resistance to motion of its particles. Measuring a fluid's resistance to flow will give coefficient of viscosity. High viscosity fluids are resistant to flow and appear thick and sluggish. Viscosity is independent of specific gravity and increases with increase in temperature. Viscous fluids tend to reduce the capacity, head and efficiency while increasing the brake horsepower required. Centrifugal Pumps may be used for viscosities upto 1000 1500 SSU. Above this limit Rotary Pumps are used

Calculation of Total Head

Total Head H of the Pumpset is given by :
 (Ref. Sketch)

$$2 H = HS^* + Hd + hfs^* + hfd + HLf + \frac{Vd}{2g}$$

* In case of submersible Pumpset HS & hfs = 0

- Where**
- HS = Static suction lift, the difference in level between the center line of pump and the water level in the sump in feet or metres.
 - Hd = Static Delivery head, the difference in level between the centre line of the pump and the highest point in the delivery line in feet or metres.
 - hfs = Friction losses in suction pipe line in feet or metres.
 - hfd = Friction losses in delivery pipe line in feet or metres.
 - HLf = Total friction losses due to pipe fittings in suction and delivery pipeline in feet or meters, e.g. strainer with foot valve, bends, valves, etc.
 - $\frac{2 Vd}{2g}$ = Velocity head of water in the delivery pipe in feet or meters.

Where $Vd =$ Velocity of water in delivery pipe = $\frac{\text{Discharge}}{\text{Area of pipe in ft}^2 \text{ or m}^2 \text{ / sec}}$

$$2 g = \text{Acceleration due to gravity} = 9.81 \text{ m/sec}^2 = 32.2 \text{ ft/sec}^2$$

To calculate the above parameters, the following details are required.

- a. Required discharge in LPM or GPM.
- b. Size and length of the suction & delivery pipes.
- c. Size, type and number of pipe fittings on suction and delivery sides.
- d. Variation in water level on suction side.

In working out the above, care has to be taken to see that constant units are used.

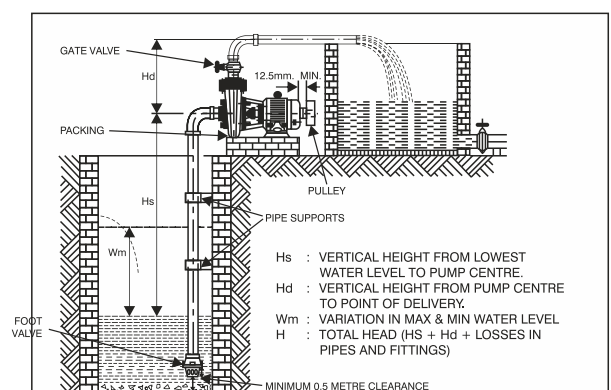

TABLE II

Length of straight pipe in meters giving equivalent resistance of flow in valves and fittings.

| Size of pipe mm | 90° Elbow (Std) | 90° Medium Elbow | 90° long Elbow | 45° Elbow | TEE | Return Bend | Gate Valve | Globe Valve | Angle Valve | Foot Valve or Check Valve (NRV) |
|-----------------|-----------------|------------------|----------------|-----------|-------|-------------|------------|-------------|-------------|---------------------------------|
| 13 | 0.46 | 0.43 | 0.34 | 0.24 | 1.04 | 1.16 | 0.107 | 4.90 | 2.56 | 1.01 |
| 20 | 0.61 | 0.55 | 0.43 | 0.31 | 1.37 | 1.53 | 0.143 | 6.70 | 3.66 | 1.53 |
| 25 | 0.82 | 0.70 | 0.52 | 0.40 | 1.77 | 1.86 | 0.18 | 8.24 | 4.57 | 2.04 |
| 40 | 1.31 | 1.10 | 0.85 | 0.61 | 2.74 | 3.05 | 0.29 | 13.40 | 6.71 | 3.05 |
| 50 | 1.67 | 1.40 | 1.07 | 0.76 | 3.35 | 3.96 | 0.37 | 17.40 | 8.54 | 3.96 |
| 63 | 1.98 | 1.65 | 1.28 | 0.92 | 4.26 | 4.57 | 0.42 | 20.10 | 10.00 | 5.18 |
| 76 | 2.47 | 2.00 | 1.55 | 1.15 | 5.18 | 5.49 | 0.52 | 25.90 | 12.00 | 6.10 |
| 100 | 3.35 | 2.77 | 2.13 | 1.53 | 6.71 | 7.31 | 0.70 | 33.50 | 17.70 | 8.23 |
| 125 | 4.26 | 3.66 | 2.78 | 1.86 | 8.24 | 9.45 | 0.88 | 42.60 | 21.30 | 10.00 |
| 150 | 4.87 | 4.26 | 3.35 | 2.35 | 10.80 | 11.50 | 1.07 | 47.70 | 25.30 | 12.20 |
| 200 | 6.40 | 5.48 | 4.26 | 3.05 | 13.10 | 14.90 | 1.37 | 67.10 | 33.50 | 16.20 |
| 250 | 7.62 | 6.71 | 5.18 | 3.96 | 17.10 | 19.00 | 1.74 | 88.50 | 42.60 | 20.40 |
| 300 | 9.75 | 7.92 | 6.10 | 4.57 | 20.10 | 23.00 | 2.04 | 100.50 | 51.80 | 24.40 |

Friction in long pipeline is to be calculated.

TABLE 2: Frictional head lost in GI pipe

| Q Lpm (Nominal dia mm) | Head lost in m per 100m | | | | |
|---------------------------|-------------------------|-------|-------|------|------|
| | 40 | 50 | 65 | 80 | 100 |
| 40 | 1.15 | 0.38 | 0.10 | 0.03 | 0.01 |
| 60 | 2.57 | 0.84 | 0.22 | 0.08 | 0.03 |
| 80 | 4.58 | 1.50 | 0.40 | 0.14 | 0.05 |
| 100 | 7.16 | 2.36 | 0.63 | 0.22 | 0.07 |
| 120 | 10.30 | 3.38 | 0.91 | 0.32 | 0.11 |
| 150 | 16.10 | 5.30 | 1.42 | 0.50 | 0.17 |
| 180 | 23.20 | 7.60 | 2.05 | 0.72 | 0.24 |
| 240 | 41.25 | 13.52 | 3.64 | 1.29 | 0.42 |
| 300 | 64.45 | 21.12 | 5.69 | 2.01 | 0.66 |
| 360 | - | 30.41 | 8.19 | 2.90 | 0.95 |
| 400 | - | 37.55 | 10.11 | 3.58 | 1.17 |
| 500 | - | - | 15.80 | 5.59 | 1.83 |

Note: For intermediate value Q find head lost in friction hf_q by following formula

$$Hf_q = (Q/Q_1) \times (Q/Q_1) \times hf_{q1}$$

Where hf_{q1} is head lost in Q_1 discharge.

d) Water requirement:

The water requirement of the crop depends upon the

- (i) Nature of the crop | (ii) Atmospheric conditions | (iii) Nature of soil

CONVERSION TABLE

| Discharge: | |
|------------------|---------------------|
| 1 Imp Gallon | 4.546 ltrs. |
| 1 US Gallon | 3.785 ltrs. |
| 1 Cu m. | 1000 ltrs. |
| 1 Cu ft. | 28.32 ltrs. |
| Discharge rate : | |
| 3 l m /h | 16.67 l/min. |
| 3 l m /s | 60,000 l/min. |
| 1 l/s | 60 l/min |
| 1 Cu ft/s | 1699.2 l/min. |
| 1 Imp. GPH | 0.0757 l/min |
| | 0.00126 l/Sec. |
| Head: | |
| 1 mtrs. | 3.28 ft. |
| 1 ft. | 0.3048 m. |
| 2 l kg/cm | 10 mtrs |
| Pressure: | |
| 2 l Atmosphere | 1.033 kg/cm |
| 2 l Atmosphere | 14.7 lb/in |
| 1 Atmosphere | 10.34 mwc |
| 2 l lb/in | 0.704 mwc |
| 2 l lb/in | 2.31 ft wc |
| 2 l lb/in | 51.6 mm of mercury. |
| 1 cusec | 1705 lpm |
| | 1 Acre inch/hr |
| 1 Cu mec | 20558.3 lpm. |
| | 1 Acre ft/hr. |
| Power: | |
| 1 HP (Si) | 0.746 kW |
| | 746 W |
| 1 HP (Metric) | 0.736 kW |
| | 736W |
| 1 kW | 1000 W |
| Weight: | |
| 1 kg. | 1000 gm. |
| 1 kg. | 2.2046 lb. |
| 1 lb. | 0.4536 kg. |

DISCHARGE RATE TABLE

| Veenotch reading in inch | Veenotch reading in mm. | Discharge rate in GPH (imp) | Discharge rate in lpm. |
|--------------------------|-------------------------|-----------------------------|------------------------|
| 1/2" | 12.7 | 21 | 1.59 |
| 3/4" | 19.05 | 57.42 | 4.35 |
| 1" | 25.4 | 117.22 | 8.88 |
| 1 1/4" | 31.75 | 203.8 | 15.44 |
| 1 1/2" | 38.1 | 320.5 | 24.28 |
| 1 3/4" | 44.45 | 469.52 | 35.57 |
| 2" | 50.8 | 653.8 | 49.53 |
| 2 1/4" | 57.15 | 875.56 | 66.33 |
| 2 1/2" | 63.5 | 1137.05 | 86.14 |
| 2 3/4" | 69.85 | 1440.12 | 109.1 |
| 3" | 76.2 | 1786.49 | 135.39 |
| 3 1/4" | 82.55 | 2179.45 | 165.11 |
| 3 3/4" | 95.25 | 3108.07 | 235.46 |
| 4" | 101.6 | 3647.56 | 276.33 |
| 4 1/4" | 107.95 | 4239.31 | 321.16 |
| 4 1/2" | 114.3 | 4884.92 | 370.07 |
| 4 3/4" | 120.65 | 5585.84 | 423.17 |
| 5" | 127 | 6343.95 | 480.6 |
| 5 1/4" | 133.35 | 7159.55 | 542.39 |
| 5 1/2" | 139.7 | 8034.97 | 608.71 |
| 5 3/4" | 146.05 | 8991.64 | 679.67 |
| 6" | 152.4 | 9970.22 | 755.32 |
| 6 1/4" | 158.75 | 11032.43 | 835.79 |
| 6 1/2" | 165.1 | 12159.44 | 921.17 |
| 6 3/4" | 171.45 | 13352.46 | 1011.55 |
| 7" | 177.08 | 14466.41 | 1095.94 |
| 7 1/4" | 184.15 | 15941.38 | 1207.68 |
| 7 1/2" | 190.5 | 17339.65 | 1313.61 |
| 7 3/4" | 196.85 | 18808.55 | 1424.89 |
| 8" | 203.2 | 20349.38 | 1541.62 |

For Single Phase Motor maximum length of copper cable :

| MOTOR RATING | | | CABLE SIZE IN SQUARE MILLIMETERS | | | | | | | | | | | |
|-----------------------------|------|------|----------------------------------|-----|-----|-----|-----|------|------|------|------|------|------|-----------------------------------|
| VOLTS | kW | HP | 1.5 | 2.5 | 4 | 6 | 10 | 16 | 25 | 35 | 50 | 70 | 95 | |
| 220-240 VOLT 50Hz | 0.37 | 0.5 | 120 | 200 | 320 | 480 | 810 | 1260 | 1900 | 2590 | 3580 | 4770 | 5920 | MAXIMUM LENGTH IN METERS |
| | 0.55 | 0.75 | 80 | 130 | 250 | 320 | 550 | 850 | 1290 | 1760 | 2430 | 3230 | 4000 | |
| | 0.75 | 1.0 | 60 | 100 | 170 | 250 | 430 | 670 | 1010 | 1380 | 1910 | 2550 | 3160 | |
| | 1.1 | 1.5 | 40 | 70 | 120 | 180 | 300 | 470 | 710 | 980 | 1360 | 1850 | 2320 | |
| | 1.5 | 2.0 | 30 | 60 | 90 | 130 | 230 | 360 | 550 | 760 | 1060 | 1440 | 1820 | |
| | 2.2 | 3.0 | - | 40 | 60 | 100 | 170 | 280 | 430 | 600 | 820 | 1080 | 1310 | |

For Three Phase Motor maximum length of copper cable :

| MOTOR RATING | | | CABLE SIZE IN SQUARE MILLIMETERS | | | | | | | | | | | | |
|-----------------------------|-------|------|----------------------------------|-----|------|------|------|------|------|------|------|------|------|-----|-----------------------------------|
| VOLTS | kW | HP | 1.5 | 2.5 | 4 | 6 | 10 | 16 | 25 | 35 | 50 | 70 | 95 | 120 | |
| 380-415 VOLT 50Hz | 0.75 | 1.0 | 380 | 630 | 1020 | 1525 | 2595 | 4032 | 6111 | 8366 | - | - | - | - | MAXIMUM LENGTH IN METERS |
| | 1.1 | 1.5 | 300 | 500 | 810 | 1210 | 2060 | 3200 | 4850 | 6640 | 9220 | - | - | - | |
| | 1.5 | 2.0 | 220 | 370 | 590 | 880 | 1500 | 2340 | 3560 | 4890 | 6830 | 9230 | - | - | |
| | 2.2 | 3.0 | 150 | 250 | 400 | 600 | 1030 | 1600 | 2440 | 3350 | 4680 | 6340 | 7990 | - | |
| | 3 | 4.0 | 110 | 190 | 310 | 460 | 790 | 1230 | 1880 | 2590 | 3630 | 4930 | 6230 | - | |
| | 3.7 | 5.0 | 90 | 150 | 240 | 370 | 630 | 980 | 1490 | 2050 | 2870 | 3900 | 4920 | - | |
| | 4 | 5.5 | 80 | 140 | 230 | 340 | 590 | 920 | 1390 | 1910 | 2670 | 3600 | 4520 | - | |
| | 4.5 | 6.0 | 70 | 130 | 220 | 320 | 550 | 860 | 1310 | 1790 | 2510 | 3390 | 4260 | - | |
| | 5.5 | 7.5 | 60 | 110 | 170 | 260 | 440 | 690 | 1060 | 1450 | 2030 | 2750 | 3460 | - | |
| | 7.5 | 10.0 | 50 | 80 | 130 | 200 | 340 | 530 | 810 | 1110 | 1560 | 2120 | 2680 | - | |
| | 9.3 | 12.5 | - | 60 | 110 | 160 | 280 | 440 | 670 | 920 | 1310 | 1780 | 2250 | - | |
| | 11 | 15.0 | - | 50 | 90 | 130 | 230 | 360 | 550 | 750 | 1060 | 1440 | 1820 | - | |
| | 13 | 17.5 | - | - | 80 | 110 | 200 | 310 | 480 | 650 | 920 | 1250 | 1580 | - | |
| | 15 | 20.0 | - | - | 70 | 100 | 170 | 270 | 410 | 570 | 800 | 1080 | 1370 | - | |
| | 18.5 | 25.0 | - | - | - | 80 | 140 | 210 | 330 | 450 | 630 | 860 | 1090 | - | |
| | 22 | 30.0 | - | - | - | 70 | 120 | 180 | 280 | 380 | 540 | 740 | 930 | - | |
| | 26 | 35.0 | - | - | - | - | 100 | 150 | 230 | 310 | 440 | 610 | 770 | 880 | |
| | 30 | 40.0 | - | - | - | - | 90 | 130 | 210 | 280 | 400 | 540 | 680 | 780 | |
| | 37 | 50.0 | - | - | - | - | - | 110 | 170 | 230 | 320 | 440 | 550 | 700 | |
| | 45 | 60.0 | - | - | - | - | - | - | 140 | 190 | 260 | 360 | 460 | 500 | |
| 55 | 75.0 | - | - | - | - | - | - | - | 160 | 220 | 290 | 380 | 340 | | |
| 75 | 100.0 | - | - | - | - | - | - | - | - | 160 | 220 | 260 | 340 | | |
| 93 | 125.0 | - | - | - | - | - | - | - | - | - | 170 | 220 | 260 | | |

These are maximum length of cable in METERS FROM POWER SOURCE TO MOTOR. Exceeding these lengths will void guarantee.

Sales Offices

North Region

New Delhi

Crompton Greaves Consumer Electricals Limited
3rd Floor, Express Building 9-10, Bahadur Shah Zafar Marg,
New Delhi – 110002
Ph: 011-23460700

Jaipur - Rajasthan

Crompton Greaves Consumer Electricals Limited
Center point, 3rd floor, Braghunagar, Above Indusind bank, DCM
Ajmer road, Jaipur-302006
Ph: 0141-4712700, 705

Lucknow - Uttar Pradesh

Crompton Greaves Consumer Electricals Limited
Cyber Heights, Office Space No. 210, 2nd Floor, Vibhuti Khand,
Gomti Nagar, Lucknow -226010, Uttar Pradesh
Ph: 0522-4001511

Jalandhar - Punjab

Crompton Greaves Consumer Electricals Limited
B-12/407, 2nd Floor, B/H Dada Motors, Near BSF Chowk, Ladowali
Road, Jalandhar – 144001
Ph: 0181-3051310/23

West Region

Mumbai - Maharashtra

Crompton Greaves Consumer Electricals Limited
Solitaire Business Square, A Wing - 302, Near Western
Expressway Metro, Andheri Kurla Road, Chakala, Andheri (East),
Mumbai – 400 093
Ph: 022-61132700

Pune - Maharashtra

Crompton Greaves Consumer Electricals Limited
Durwankur Apartment , Office no. 2, Wrangler Paranjpe Road,
Behind Vaishali Hotel, F.C. Road, Pune-411 004
Ph: 020-25534765-667

Nagpur - Maharashtra

Crompton Greaves Consumer Electricals Limited
2nd floor, Plot no. M-7 & 8, "Manik Bhawan", Tatyia Tope Nagar,
West High Court Road, Nagpur. Pin - 440015
Ph:0712-2560870

Ahmedabad - Gujarat

Crompton Greaves Consumer Electricals Limited
405, 4th Floor, Gala Argos, Ellis Bridge, Ahmedabad 380 006
Ph: 079-40012000/26582780

Indore - Madhya Pradesh

Crompton Greaves Consumer Electricals Limited
409, 4th floor, Satguru Parinay, Opp. C-21 mall, A.B. road, Indore
(M.P.) 452010.
Ph:0731-2498269/71

East Region

Kolkata - West Bengal

Crompton Greaves Consumer Electricals Limited
50, Chowringhee Road, 1st Floor, B Block, Kolkata -700 071, West
Bengal
Ph: 033-40514920

Guwahati - Assam

Crompton Greaves Consumer Electricals Limited
Subham Velocity, 3rd Floor – 3B, Passport Seva Kendra Building,
Hanuram Boro Path, Opposite Hotel Awesome Palace, Wal ford,
G.S. Road, PIN 781005
Ph: 8486368370

Patna - Bihar

Crompton Greaves Consumer Electricals Limited
3rd Floor, House No.9, Patliputra Colony, Patna – 800013, Bihar
Ph: 0612-2320050

Bhubaneswar - Orissa

Crompton Greaves Consumer Electricals Limited
A/2, Saheed Nagar, Near Angan Restaurant, Bhubaneswar,
Orissa-751007
Ph: 0674-2531429/2531128

Ranchi - Jharkand

Crompton Greaves Consumer Electricals Limited
ESS Agency, 3 Westend Park, Ratu Road, Near Dav Junior
School, P.O - Hehal, Kaju Bangan, Ranchi- 834005, Jharkand

South Region

Cochin - Kerala

Crompton Greaves Consumer Electricals Limited
Door No.3/578-B, Zera Tower, Cheranallor P.O, Cochin –682034
Ph: 0484-2433860/61

Chennai - Tamilnadu

Crompton Greaves Consumer Electricals Limited
3rd, Dr.M.G.RSalai K.H Road, Nungambakkam, Chennai – 600034,
Tamilnadu
Ph: 044-40989580/90

Coimbatore - Tamilnadu

Crompton Greaves Consumer Electricals Limited
SF 219, Annamalai Industrial Park, Kalapatti, Coimbatore -
641048, Tamilnadu
Ph: 7094473102/103

Bangalore - Karnataka

Crompton Greaves Consumer Electricals Limited
J.P Square, 3rd Floor, No.17,3rd Cross, 5th Main Road,
Chamarajapet, Bangalore- 560018, Karnataka
Ph: 080-41391908/23

Hyderabad - Telangana

Crompton Greaves Consumer Electricals Limited
101 & 102, Babukhan Millennium Centre, Somajiguda,
Hyderabad – 500082, Telangana
Ph: 040-40709999/62

Vijaywada - Andhra Pradesh

Crompton Greaves Consumer Electricals Limited
Sri Lakshmi Enterprises, Door no 4-5, Ganguru Village,
Penamaluru Mandalam, Vijaywada-521139

Registered office

Crompton Greaves Consumer Electricals Limited
Equinox Business Park, Tower 3, 1st Floor, LBS Marg,
Kurla (West), Mumbai-400070, India.

Toll Free No: 1800-419-0505

E-mail ID: consumer.support@crompton.co.in

Website: www.crompton.co.in

CIN No: L31900MH2015PLC262254