

QUARTZ SINK

The Trend towards Quartz for kitchens is becoming prominent due to its lavish appeal and outstanding performance. Quartz kitchen sinks are classic instances of beauty meeting strength. Available in a variety of shades and suitable sizes. These high-quality sinks are resistant to fire, frost, water, and heat, perfect for your Home.

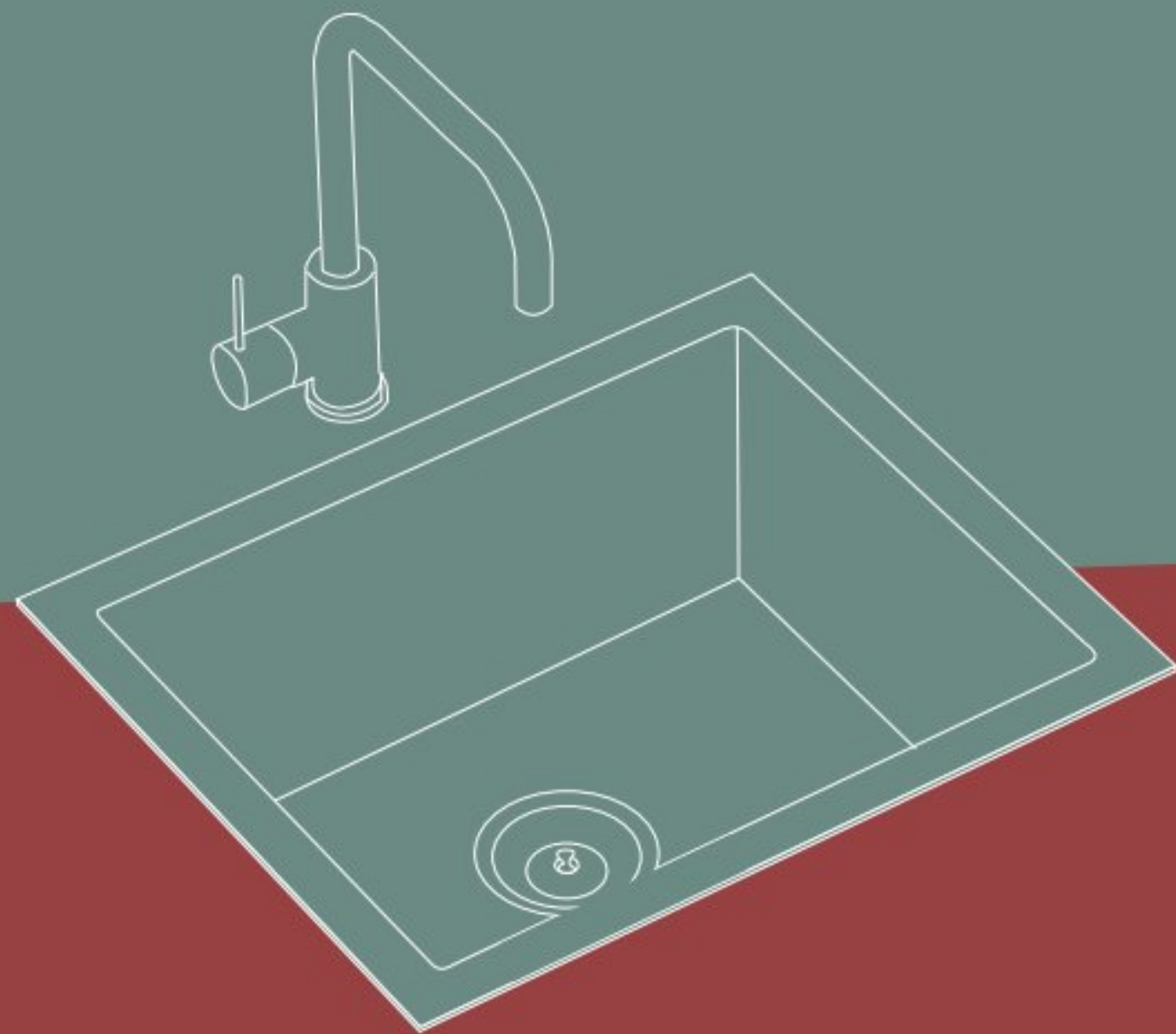

Lowest Maintenance Efforts



Liquid Repellent & Water Resistant



Natural look & Feel



100% Suitable for food use



Anti-Tarnish



Frost Resistant



High Quality



Antibacterial Surface



Excellent Wrapping Quality

HOLD THE ESSENCE OF SOLITARY





FINER
WITH
QUARTZ

Superia

COLLECTION

16x18 Inch

Presenting the new Quartz Superia collection in the ideal 16x18 inch size. A sleek design with depth that makes the kitchen look spacious, clean, and beautiful.

Overall Sink Size:
16x18x8.5 Inch

Finish:
Granite, Metallic

Weight:
9.0 Kgs. (Approx)

Installation:



Top Mount Flush Mount Under Mount

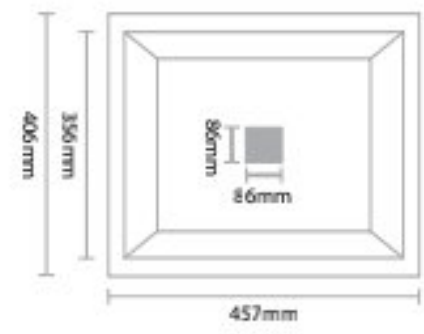

METALLIC SERIES



White Metallic



Grey Metallic



Black Metallic



Choco Metallic

GRANITE SERIES

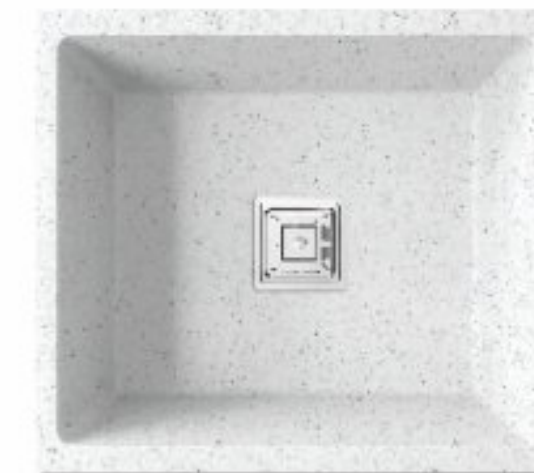

Snow Granite

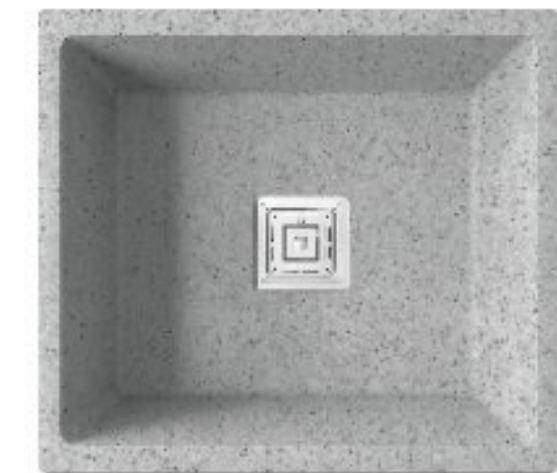

Grey Granite



Ivory Granite



Peach Granite





THE
MESMERISING
LOOK OF
METALLIC
MAGNIFICENCE

Chimera
COLLECTION

21x18 Inch

The charm of Quartz and the gleam of Metal makes it a chimera. A beautiful collection of classic designs for Indian sensibilities.

Overall Sink Size:
21x18x8.5 Inch

Finish:
Granite, Metallic

Weight:
10.5 Kgs. (Approx)

Installation:



Top Mount Flush Mount Under Mount

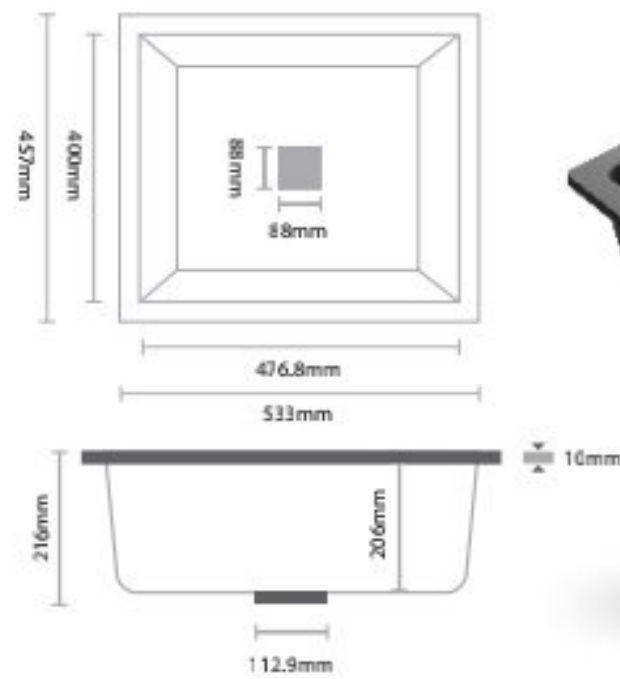

METALLIC SERIES



White Metallic



Grey Metallic

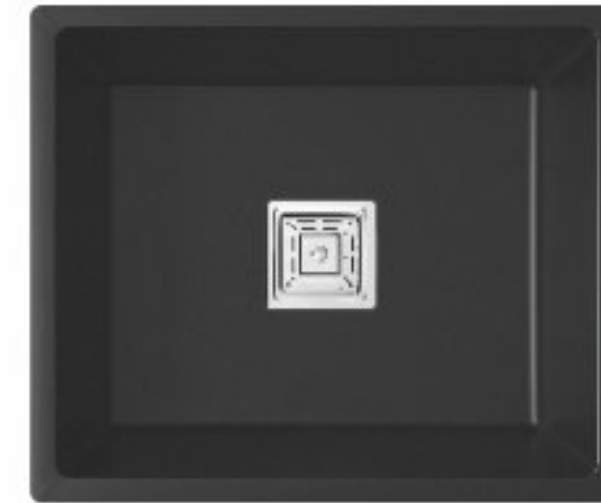

Black Metallic



Choco Metallic

GRANITE SERIES

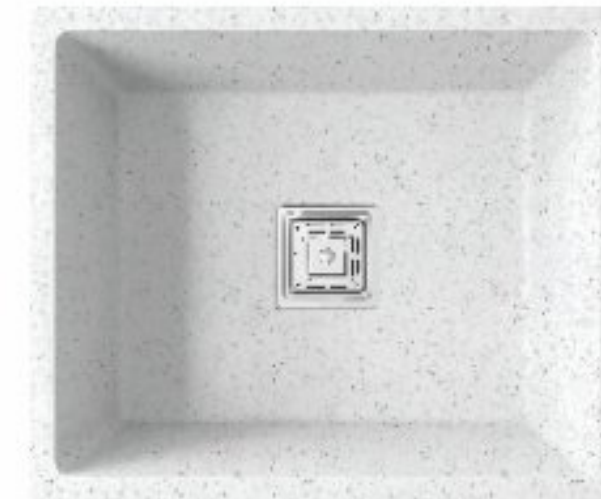

Snow Granite

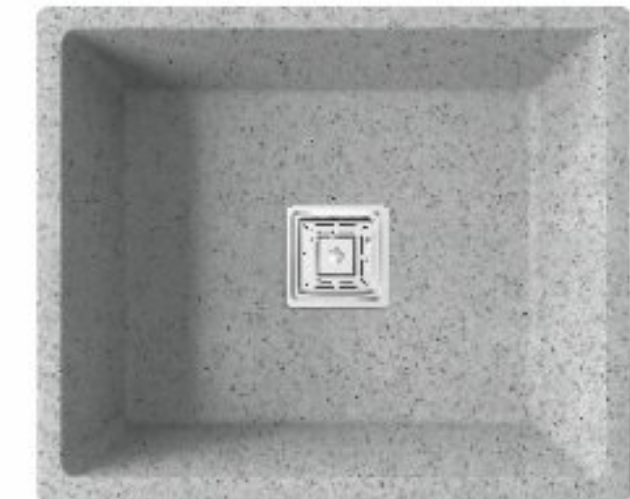

Grey Granite



Ivory Granite



Peach Granite



SUITED
FOR
SPACIOUS
KITCHENS

ultimus
COLLECTION

24x18 Inch

The ultimate style with supreme size The Ultimus collection offers smart designs and a sassy color palette to stylize your kitchen.

Overall Sink Size:
24x18x8.5 Inch

Finish:
Granite, Metallic

Weight:
11.5 Kgs. (Approx)

Installation:

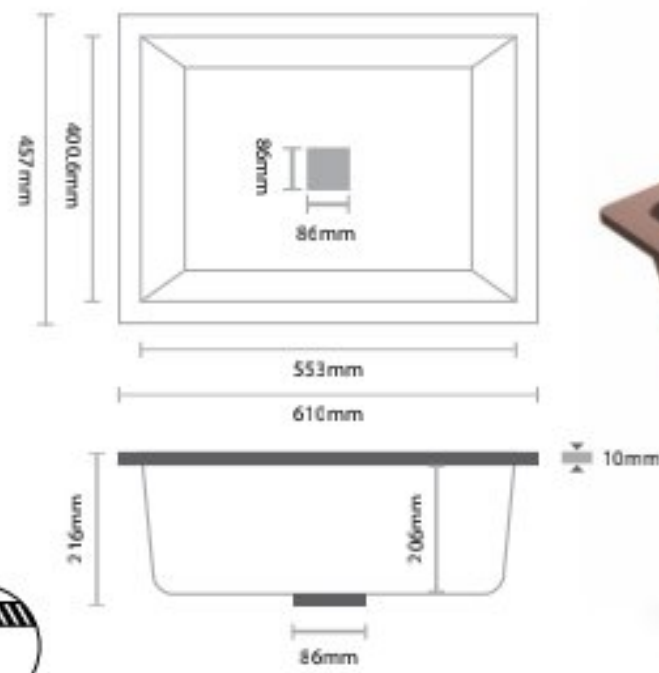

METALLIC SERIES

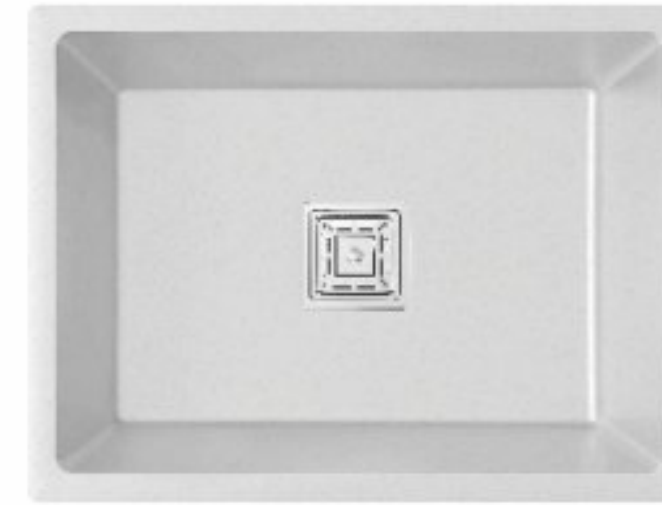

White Metallic



Grey Metallic



Black Metallic

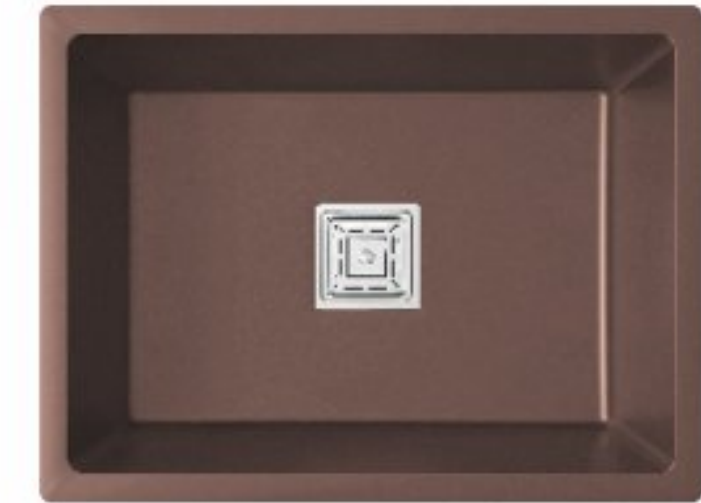

Choco Metallic

GRANITE SERIES

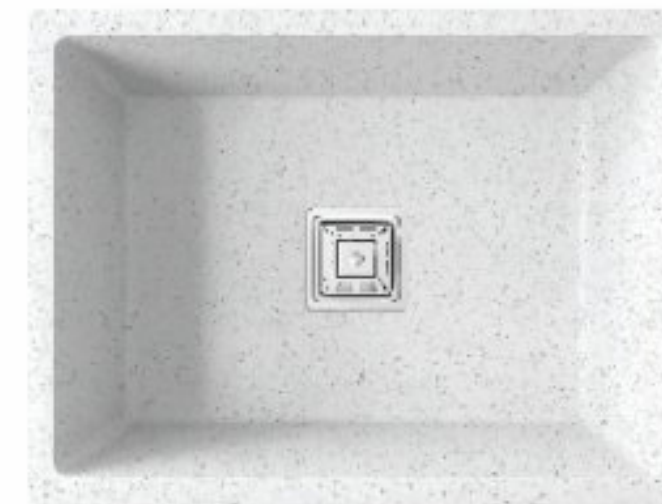

Snow Granite

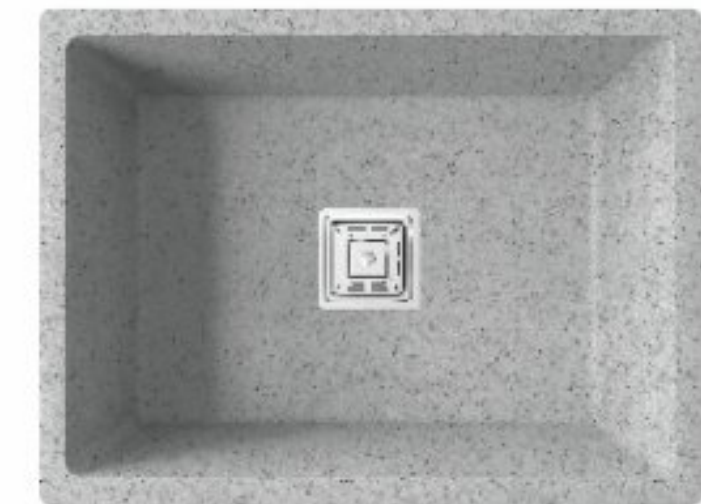

Grey Granite



Ivory Granite



Peach Granite





MAKE A
POWERFUL
PRESENCE.

Dune

COLLECTION

24x18 Inch

with Natural Quartz embedded in it, presenting the Dune Collection with amazing finish and creativity.

Overall Sink Size:
24x18x10 Inch

Finish:
Granite, Metallic

Weight:
12.5 Kgs. (Approx)

Installation:



Top Mount Flush Mount Under Mount

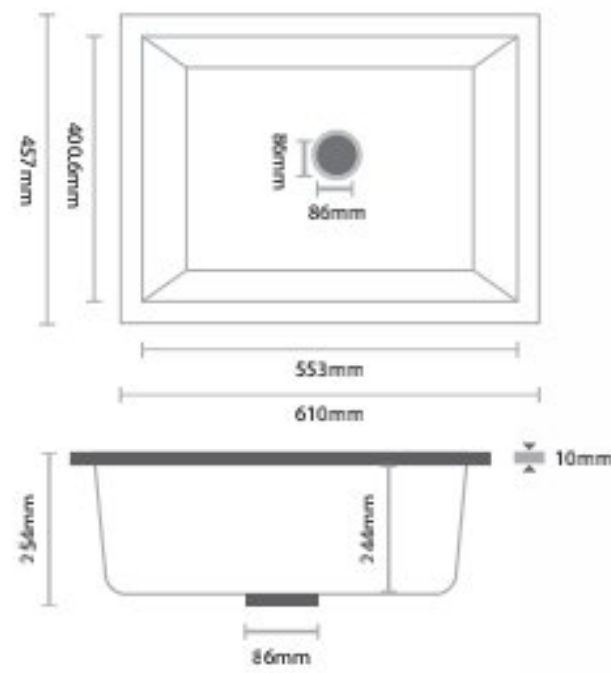

METALLIC SERIES



White Metallic



Grey Metallic



Black Metallic



Choco Metallic

GRANITE SERIES

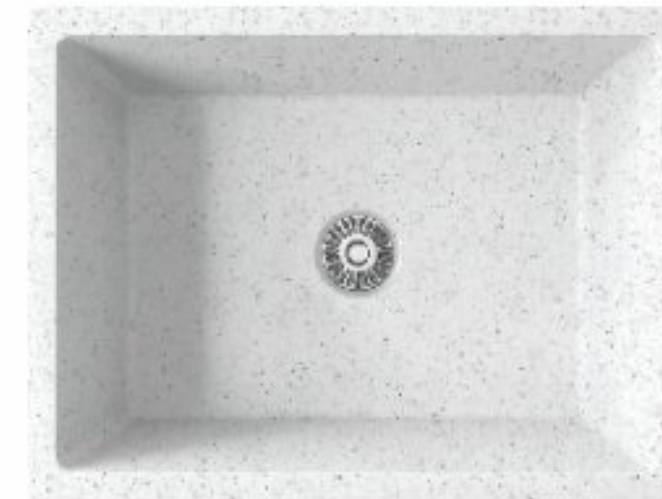

Snow Granite

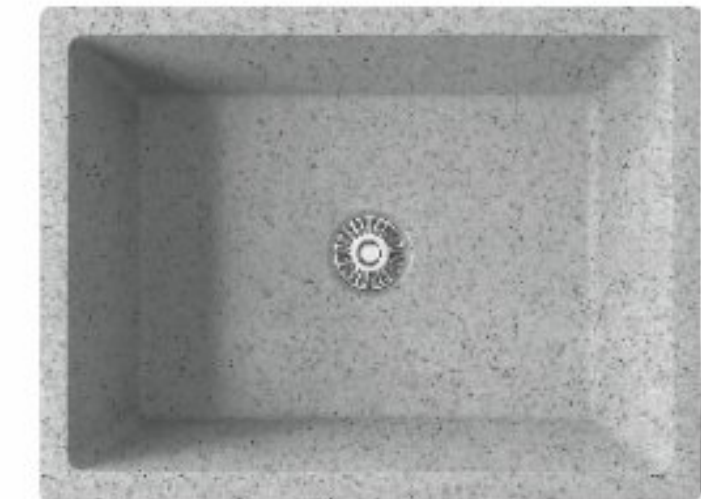

Grey Granite



Ivory Granite



Peach Granite



DESIGNED
TO
AMAZE

Tap Hole Sink

COLLECTION

30x20 Inch

Presenting the Tap Hold Sink collection, which gives a pristine
ambiance to your kitchen with its spotless design and
spacious sink.

Tap Hole Sink

COLLECTION

Thickness
= 10MM

Overall Sink Size:
30x20x9.5 Inch

Finish:
Granite, Metallic

Weight:
17 Kgs. (Approx)

Installation:

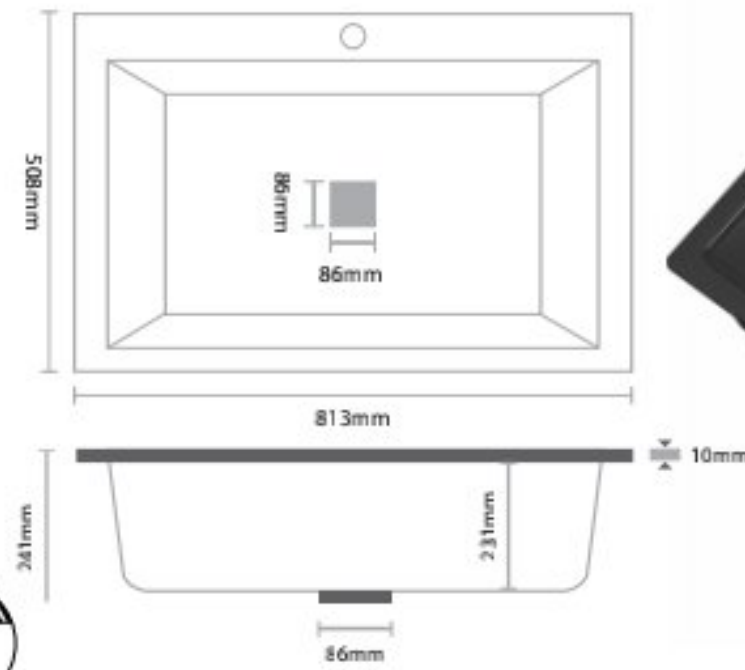

METALLIC SERIES

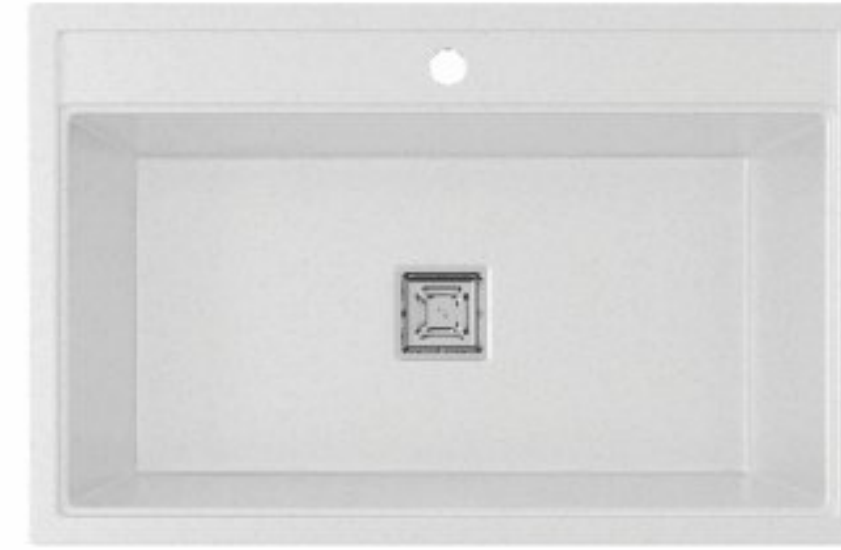

White Metallic



Grey Metallic



Black Metallic



Choco Metallic

GRANITE SERIES

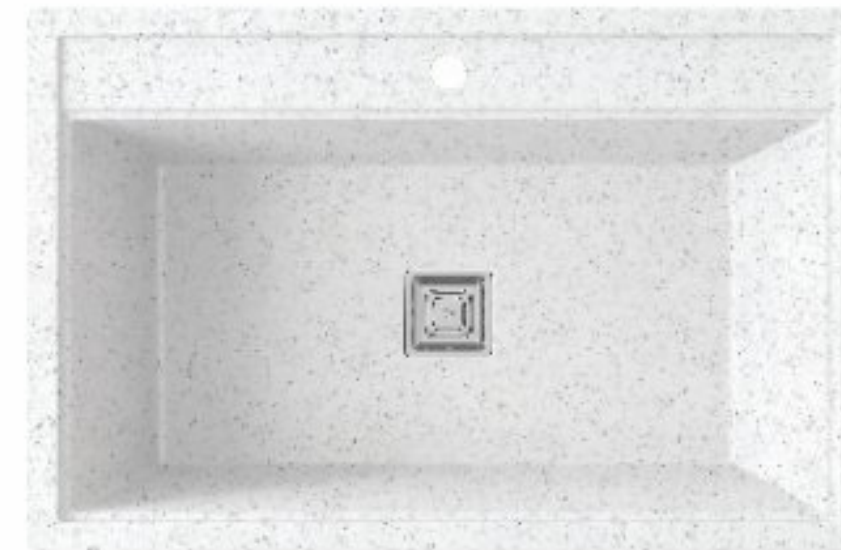

Snow Granite

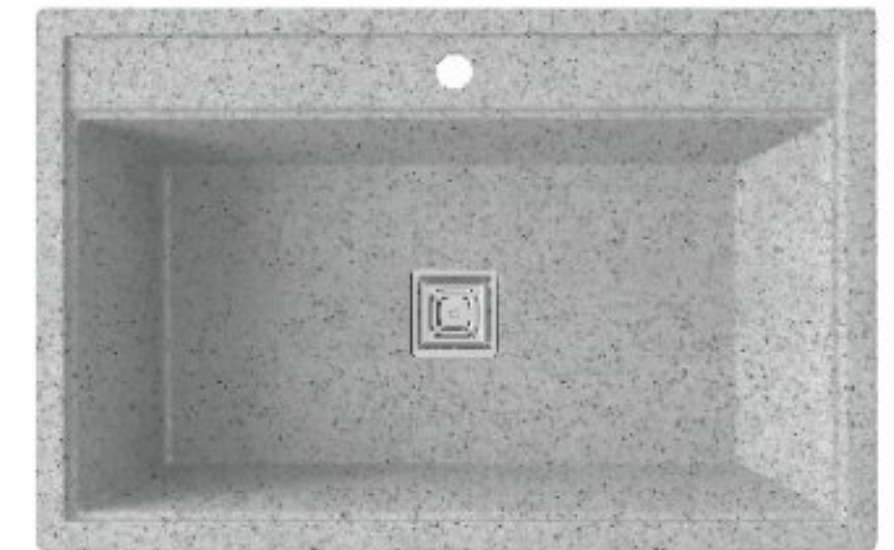

Grey Granite



Ivory Granite



Peach Granite



HIGH
ON
OPPIDAN
LOOK



urban
COLLECTION

31x19 Inch

Urban looks are in style. We are presenting an urban collection for your kitchen to have a citified look and be trendy.

Overall Sink Size:
31x19x9.5 Inch

Finish:
Granite, Metallic

Weight:
14 Kgs. (Approx)

Installation:



Top Mount Flush Mount Under Mount

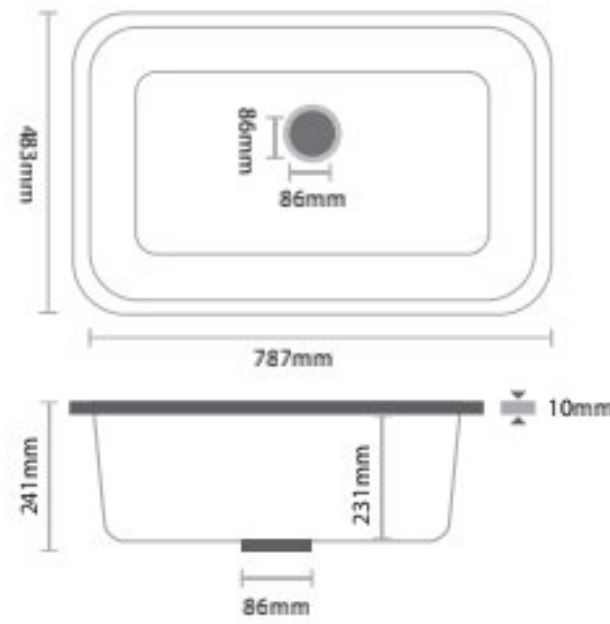

METALLIC SERIES



White Metallic



Grey Metallic



Black Metallic



Choco Metallic

GRANITE SERIES

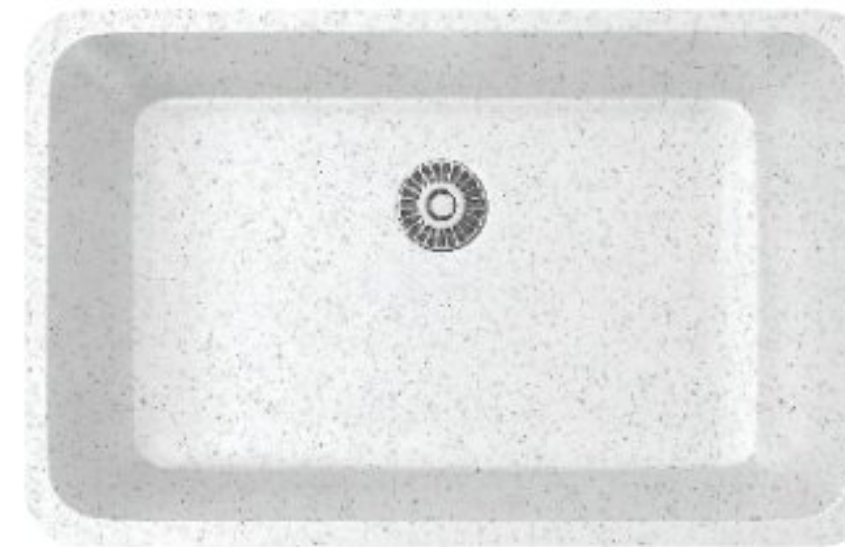

Snow Granite

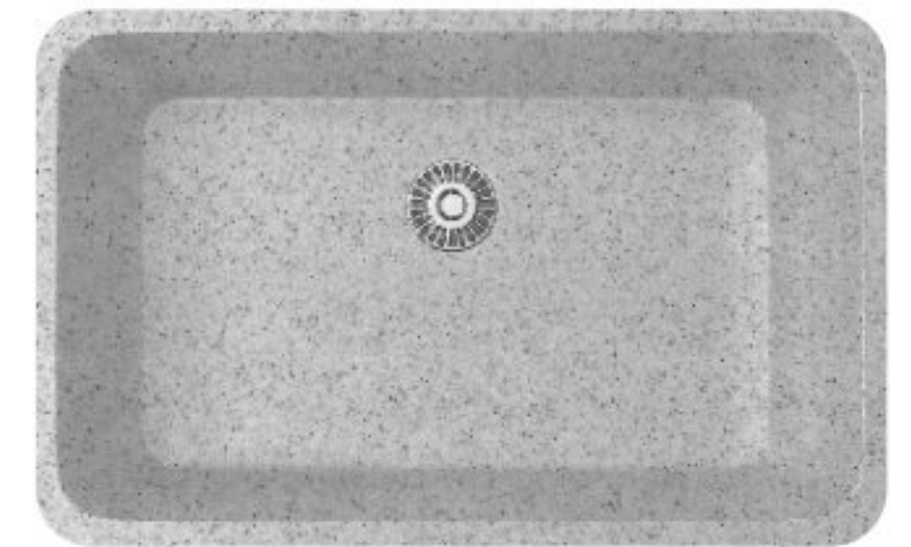

Grey Granite



Ivory Granite



Peach Granite



VAST
SPACE
WITH A
CHARM



Linea
COLLECTION

36x18 Inch

The Linea Collection, giving your kitchen an extra space for your kitchenware and utensils with its finest design.

Overall Sink Size:
36x18x8.5 Inch

Finish:
Granite, Metallic

Weight:
17 Kgs. (Approx)

Installation:



Top Mount Flush Mount Under Mount

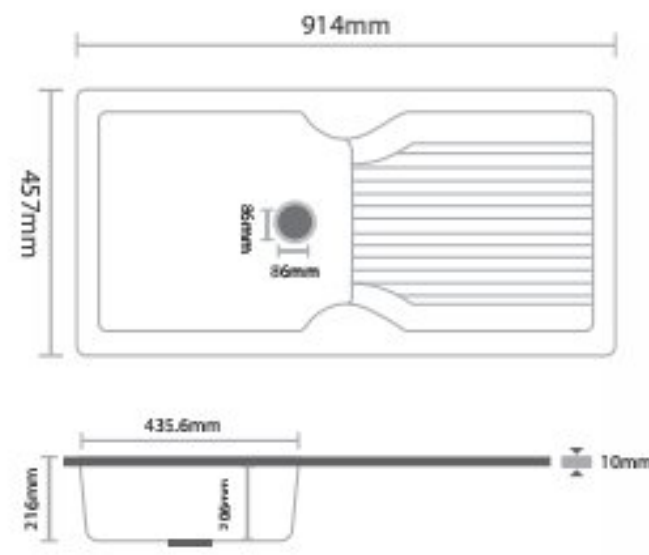

METALLIC SERIES

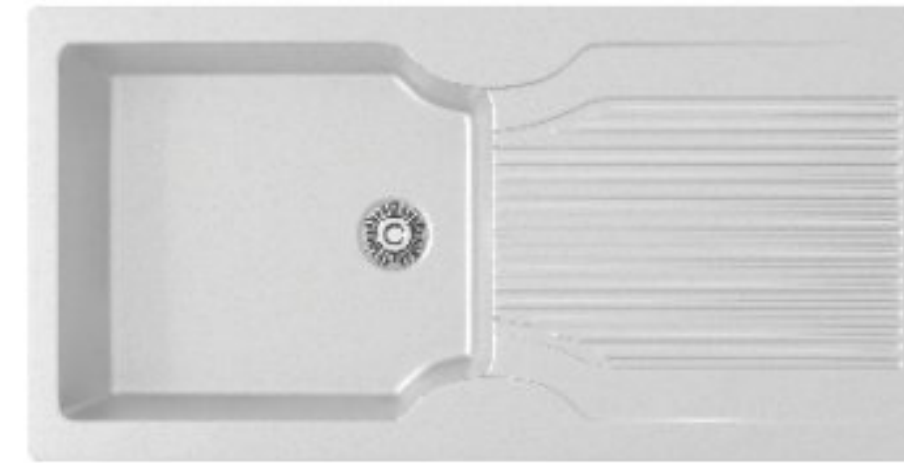

White Metallic

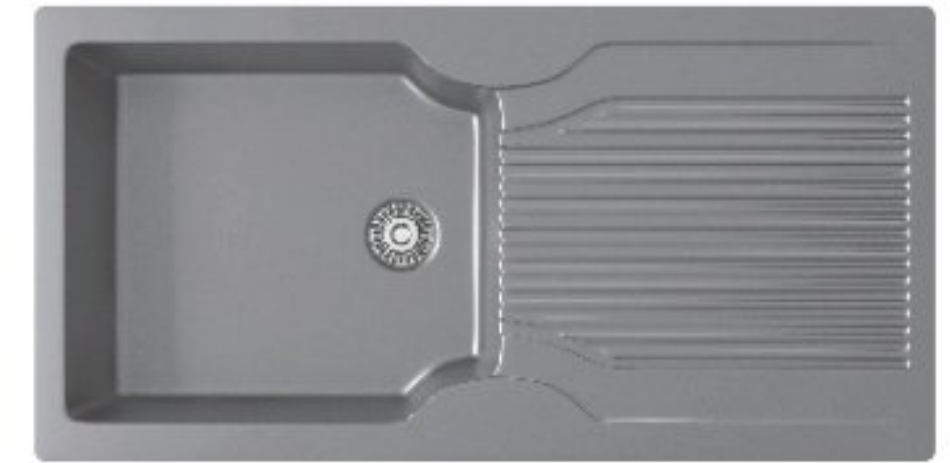

Grey Metallic



Black Metallic



Choco Metallic

GRANITE SERIES



Snow Granite

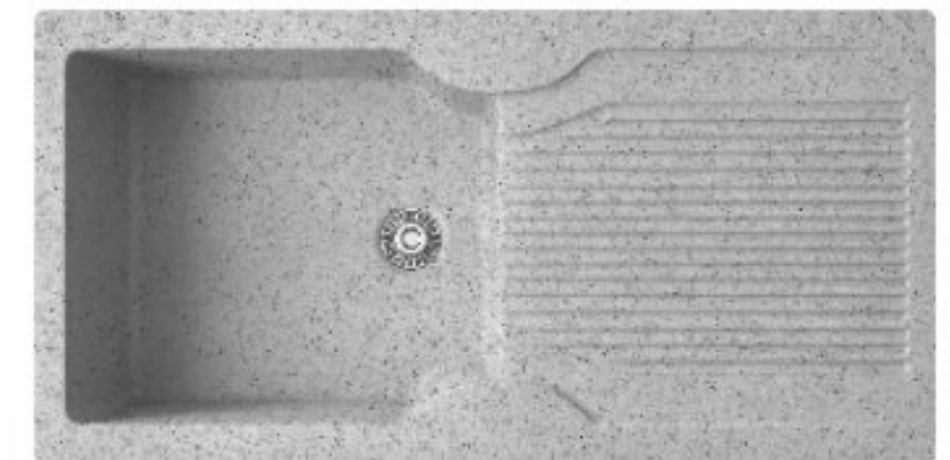

Grey Granite



Ivory Granite



Peach Granite



SURRENDER
TO
IRRESISTIBLE
ELEGANCE

venus
COLLECTION

36x18 Inch

For kitchens that look like royal quarters, here comes the fitting jewel to embellish them perfectly from The Venus Collection.

Overall Sink Size:
36x18x8.5 Inch

Finish:
Granite, Metallic

Weight:
17 Kgs. (Approx)

Installation:



Top Mount Flush Mount Under Mount

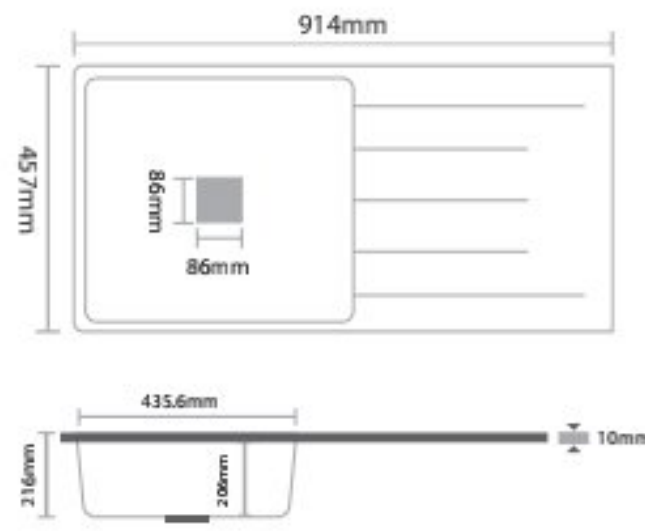

METALLIC SERIES



White Metallic



Grey Metallic



Black Metallic



Choco Metallic

GRANITE SERIES

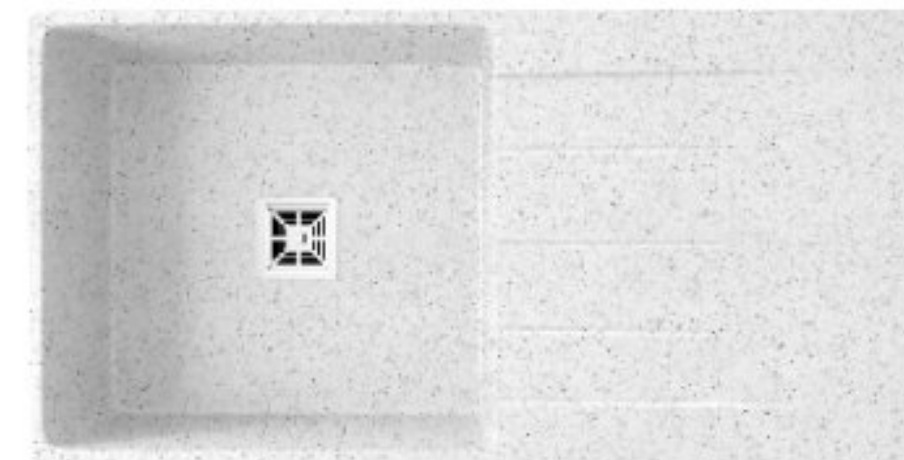

Snow Granite



Grey Granite



Ivory Granite



Peach Granite

DOUBLE THE
POWER.
DOUBLE THE
IMPACT.



Explora

COLLECTION

37x18 Inch

Exploring the new fashion for the kitchen with an impactful and highly pleasing look, here is the Explora Collection in a 37 X 18 inch size.

Overall Sink Size:
37x18x9 Inch

Finish:
Granite, Metallic

Weight:
22 Kgs. (Approx)

Installation:

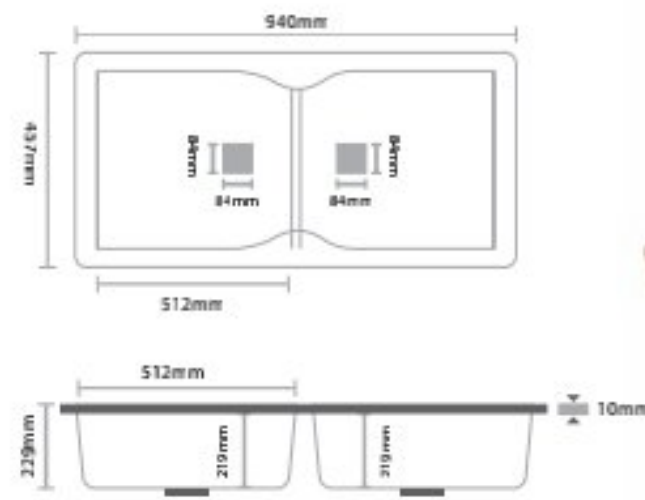

METALLIC SERIES

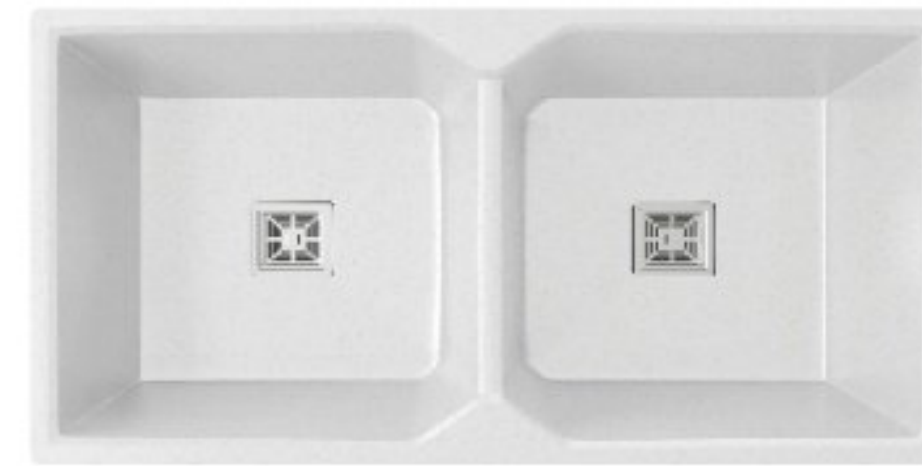

White Metallic



Grey Metallic



Black Metallic



Choco Metallic

GRANITE SERIES

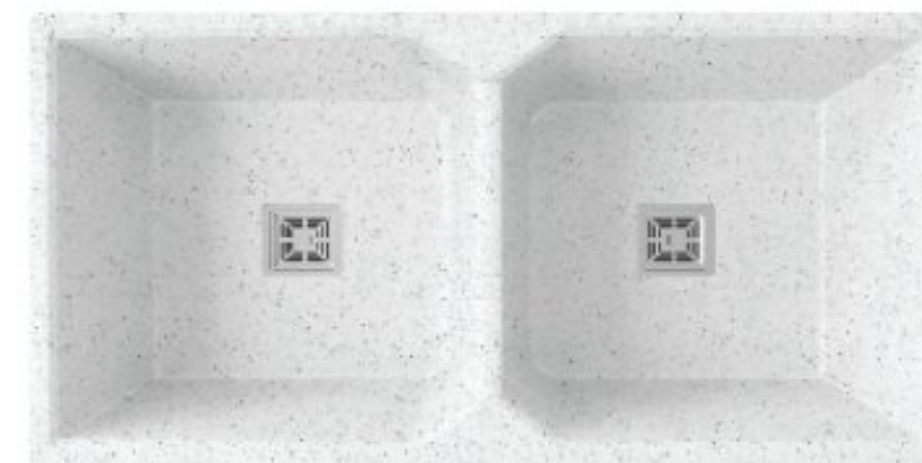

Snow Granite

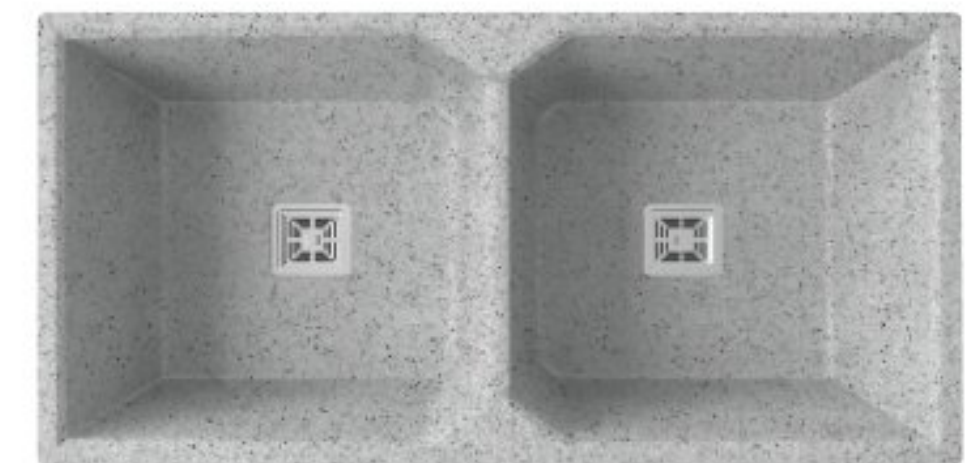

Grey Granite



Ivory Granite



Peach Granite

MATCHED
SOPHISTICATION



Bianca

COLLECTION

40x20 Inch

For busy kitchens, it's time to add more beauty with better performance. With dual basins, the Bianca collection makes your work fast and easy—beautifully.

Overall Sink Size:
40x20x9.5 Inch

Finish:
Granite, Metallic

Weight:
27 Kgs. (Approx)

Installation:



Top Mount Flush Mount Under Mount

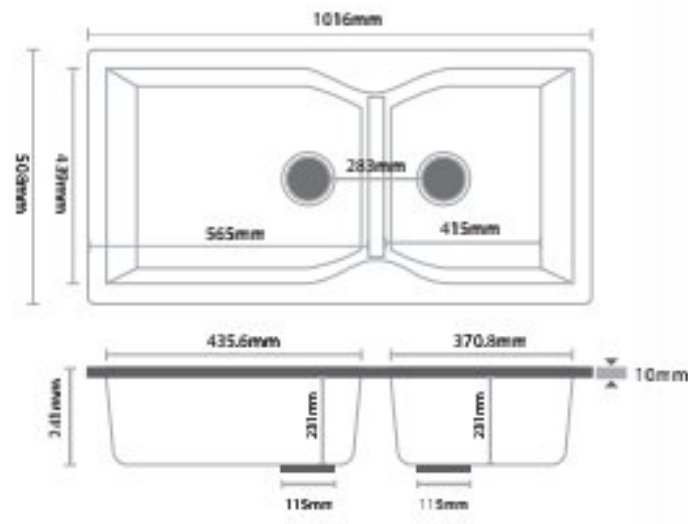

METALLIC SERIES

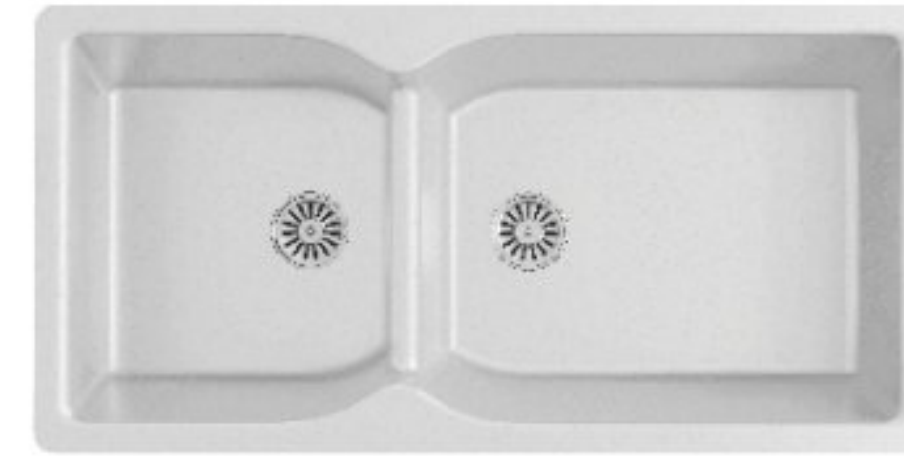

White Metallic

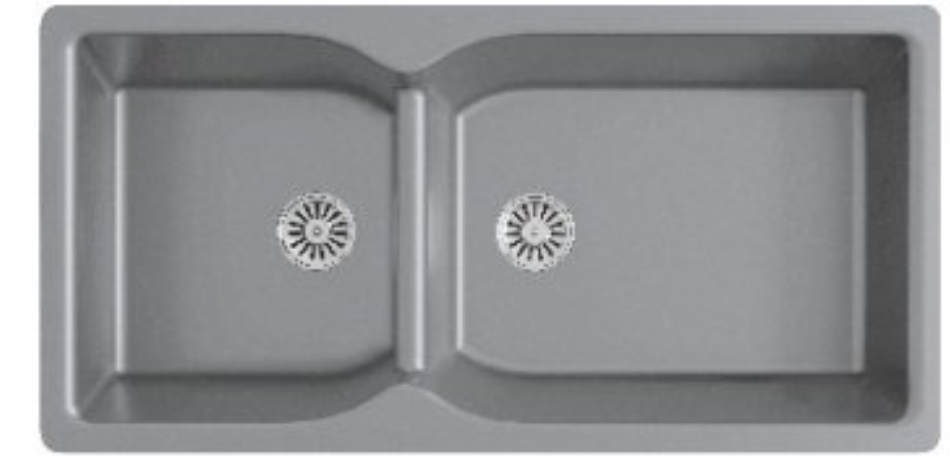

Grey Metallic

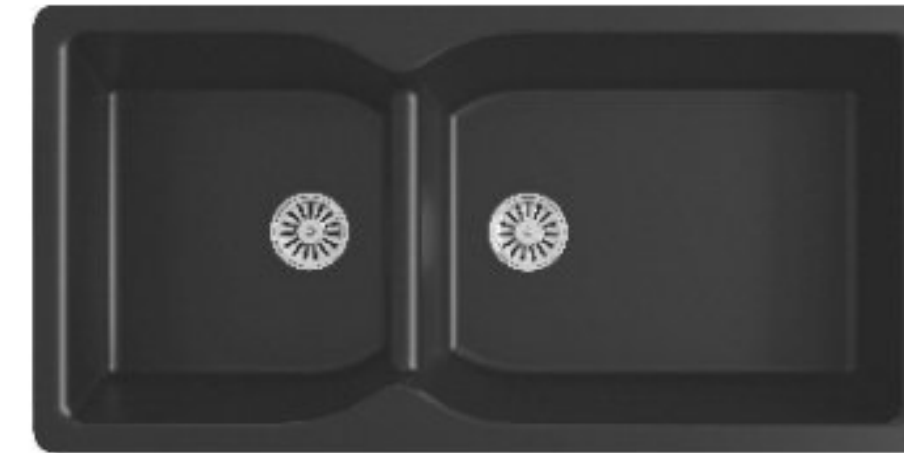

Black Metallic

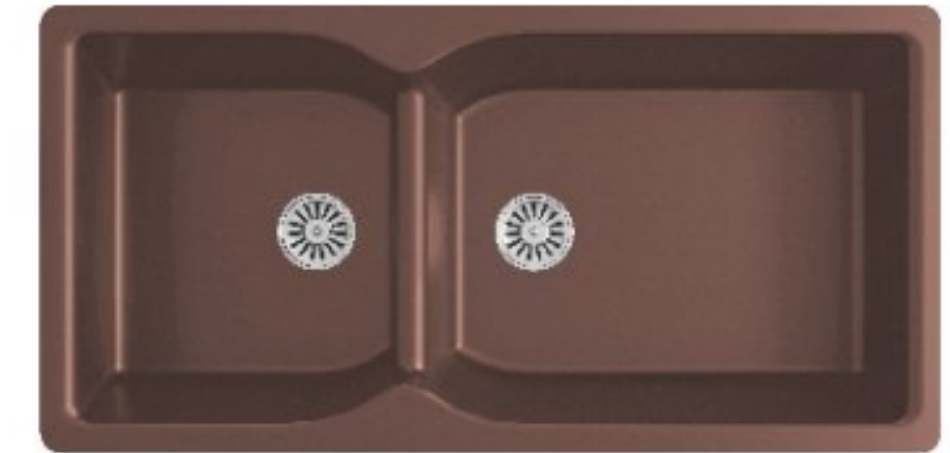

Choco Metallic

GRANITE SERIES

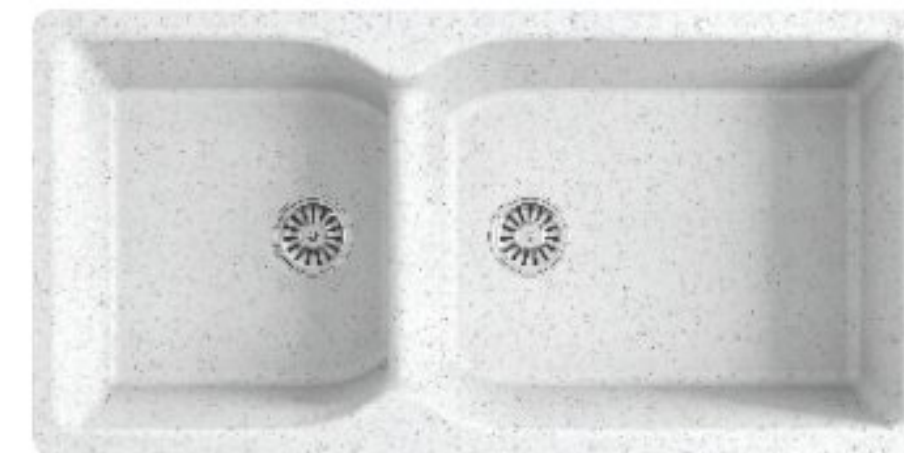

Snow Granite

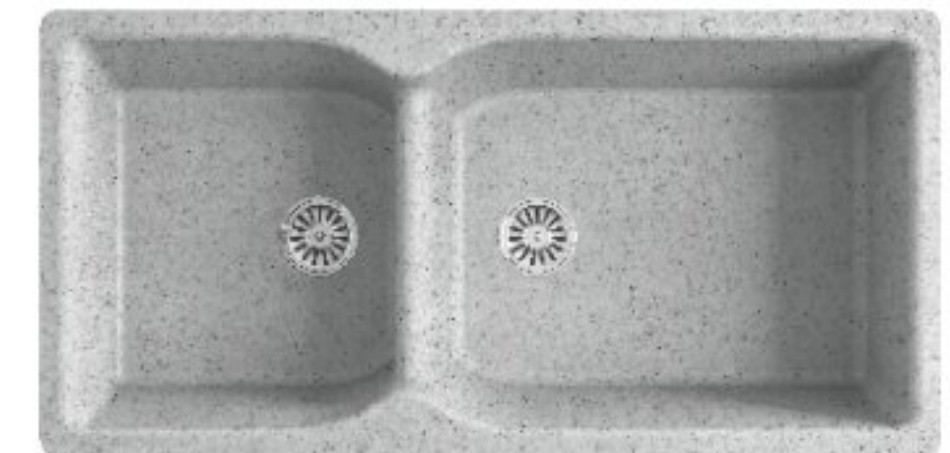

Grey Granite



Ivory Granite



Peach Granite

TWICE THE
STYLE.
TWICE THE
BOLDNESS



Bold
COLLECTION

45x20 Inch

The Bold Collection, for the bold and burly appearance of the kitchen and its everlasting capacity.

Overall Sink Size:
45x20x9.5 Inch

Finish:
Granite, Metallic

Weight:
27 Kgs. (Approx)

Installation:

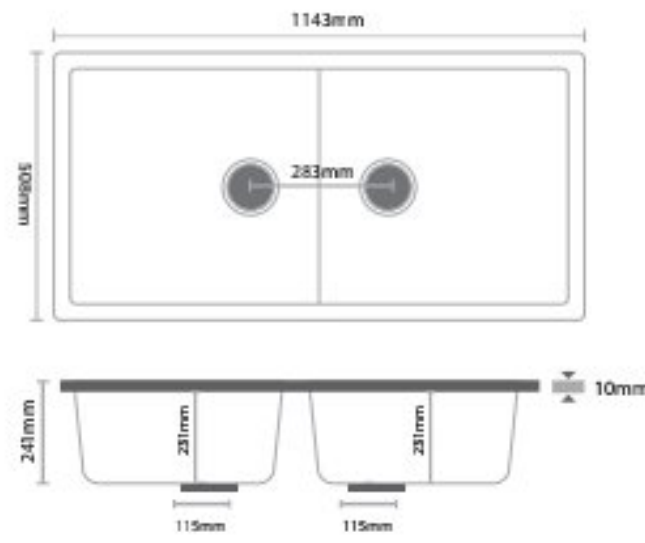

METALLIC SERIES



White Metallic



Grey Metallic



Black Metallic



Choco Metallic

GRANITE SERIES

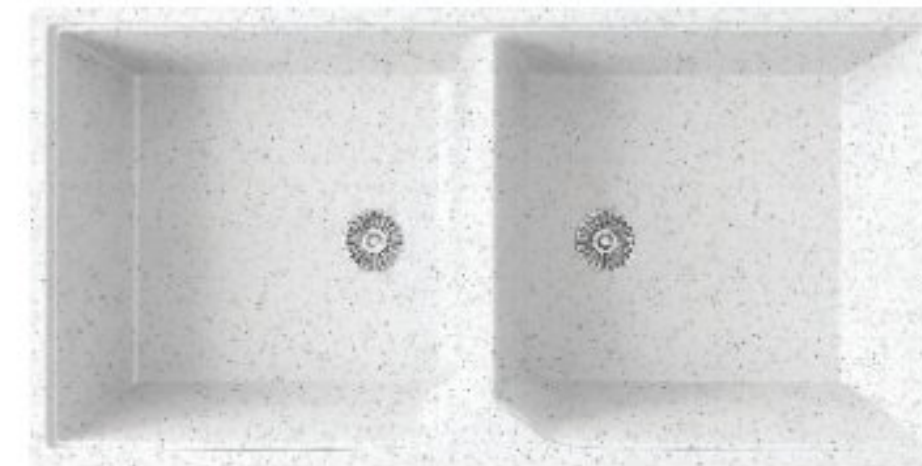

Snow Granite

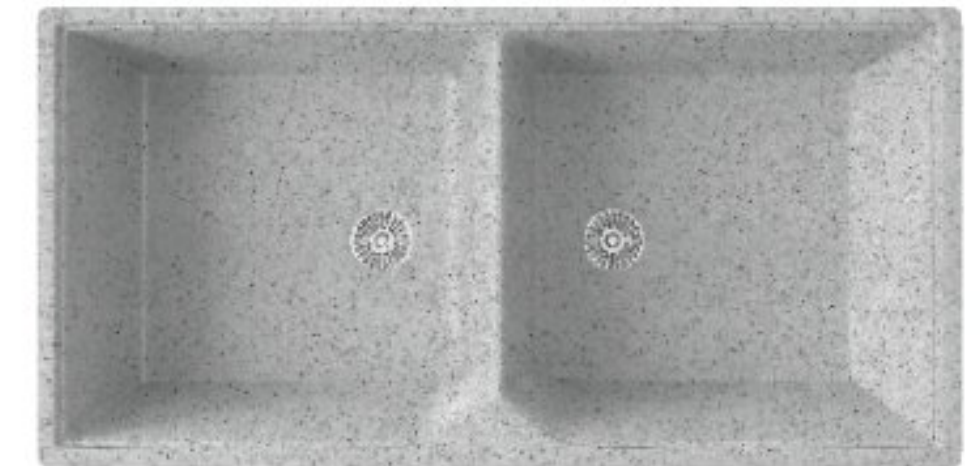

Grey Granite



Ivory Granite



Peach Granite



DUAL THE
PERFORMANCE.
DUAL THE
ELEGANCE



Elegance
COLLECTION

45x20 Inch

The Elegance Collection, as the kitchen is the heart of the home, has to be aesthetically pleasing and functional.

Overall Sink Size:
45x20x9.5 Inch

Finish:
Granite, Metallic

Weight:
25 Kgs. (Approx)

Installation:



Top Mount Flush Mount Under Mount

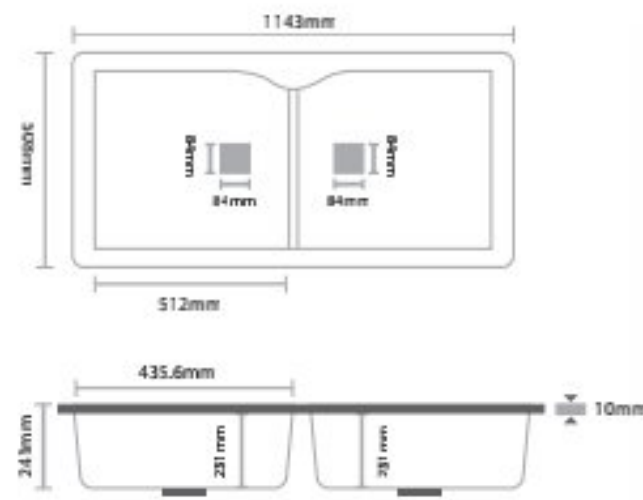

METALLIC SERIES

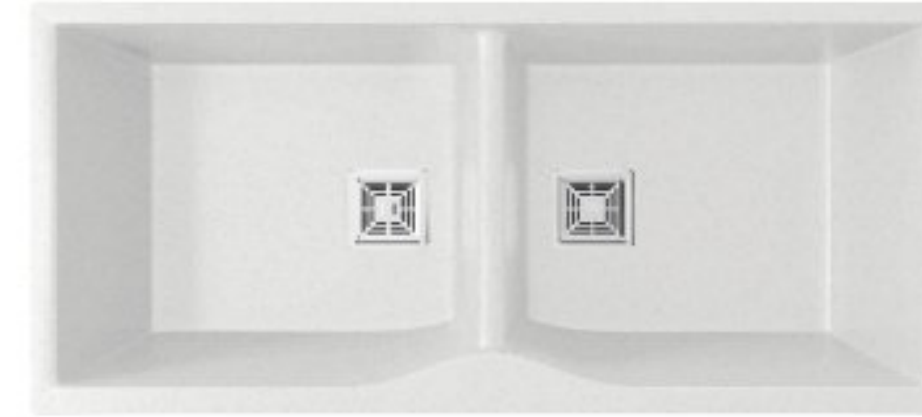

White Metallic

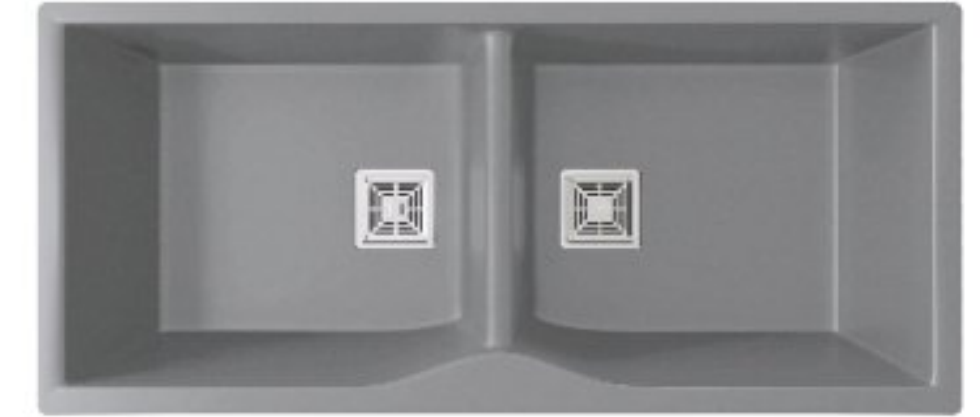

Grey Metallic

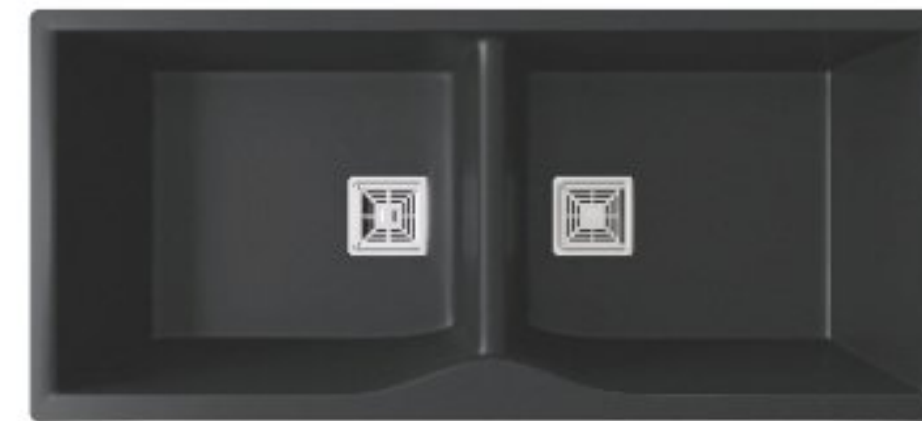

Black Metallic



Choco Metallic

GRANITE SERIES

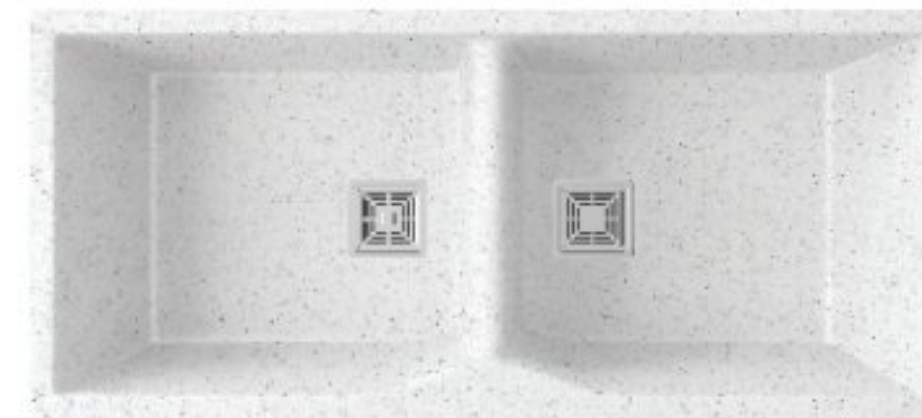

Snow Granite

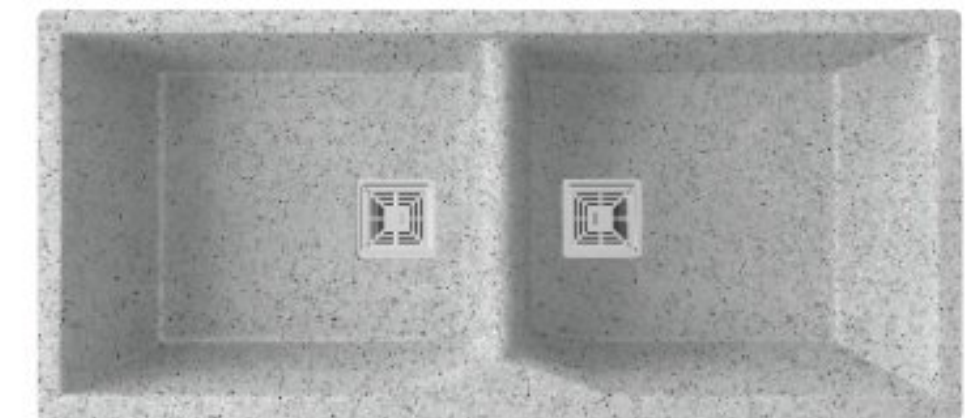

Grey Granite



Ivory Granite



Peach Granite



01
SUPER DRAIN COUPLING
MARVEL & CROWN SERIES

MRP
₹160



02
META SINK COUPLING

MRP
₹140



03
CASA ROUND COUPLING
CASA SERIES SINK COUPLING

MRP
₹120



04
FLEXIBLE HEAVY WASTE PIPE

MRP
₹50



05
FLEXIBLE MEDIUM WASTE PIPE

MRP
₹30



06
HANDMADE SQUARE COUPLING
HANDMADE & QUARTZ SERIES

MRP
₹200



07
REGULAR WASTE PIPE
HANDMADE & QUARTZ SERIES

MRP
₹30

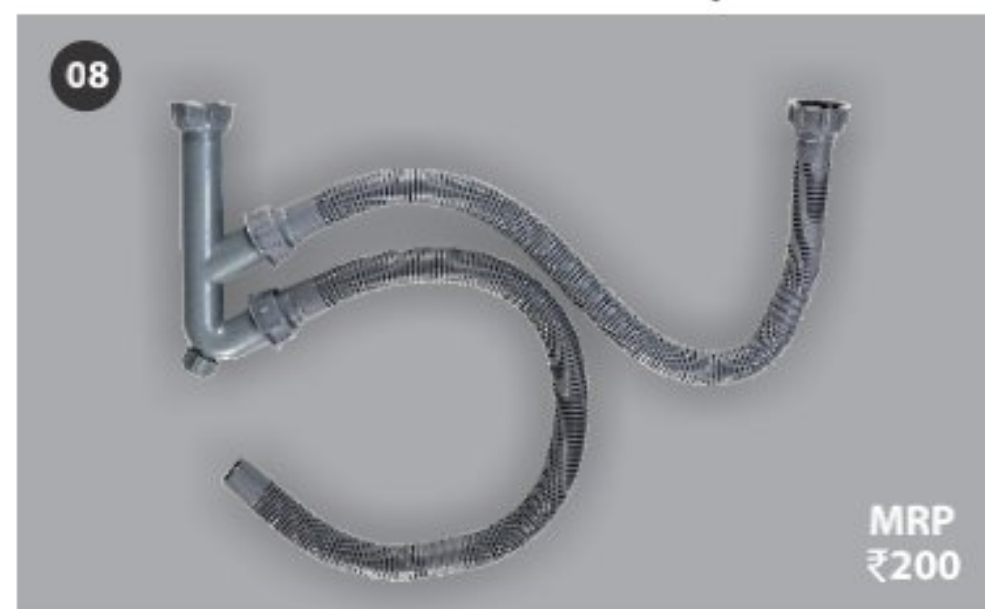

08
DUAL WASTE PIPE
DOUBLE BOWL SERIES

MRP
₹200

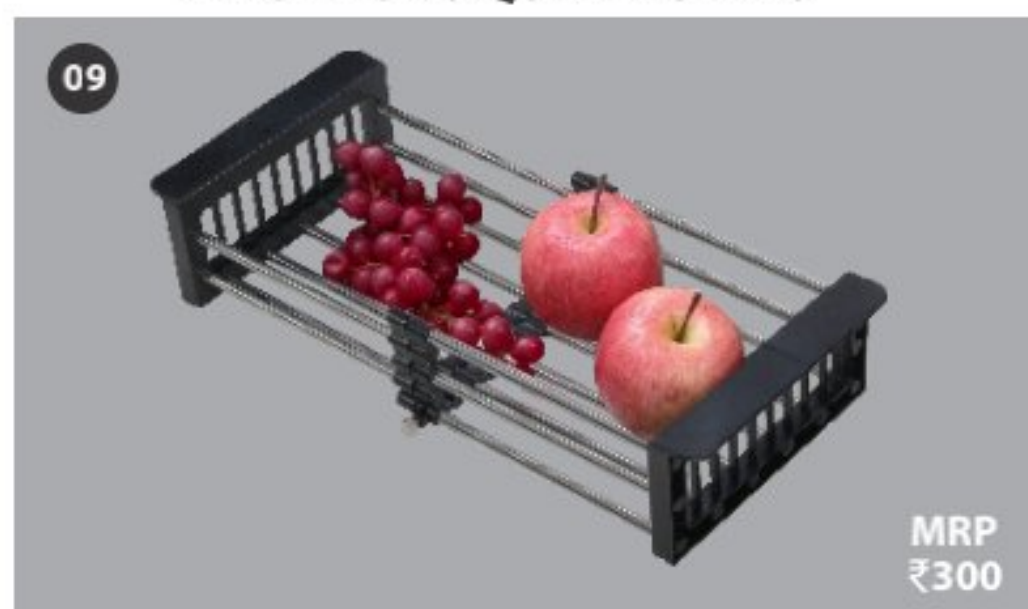

09
ADJUSTABLE BASKET

MRP
₹300

SCRATCH GUARD



GUARDING YOUR SINKS FROM SCRATCH WITH SCRATCH GUARD

Every space of the home is special and everything inside it is precious. Preserving and saving the beauty of your beautiful Sink, we have a scratch guard!

A thin plastic film over the surface that ensures hassle-free and scratch-free installation. Once you are sure of perfect installation, remove the film and reveal the beauty of your sink to the world!

SUPER DRAIN



DRAIN AWAY YOUR DRAINAGE WORRIES WITH SUPER DRAIN

Now no more worries of kitchen waste or any other waste blocking your drains and clogging your sink. Sinks comes with Super Drain!

A drain pipe that keeps clogging and cockroaches both away, giving you peace and happiness!

CHOKEFREE STRAINER



STAY FREE FROM CHOKING WITH CHOCKFREE STRAINER

1. On a similar line to Super Drain, the choke free-strainer is the perfect solution for choking and clogging the sinks due to kitchen waste.
2. Coming with small holes, the strainer stops small particles to enter the drain pipe. For better and enhanced performance, keep the strainer at an even level with a steel cup. Also if you wish to fill the sink and use it as a water tub to wash utensils in one go, push the strainer down.

UNDERCOAT



COAT YOUR CORROSION WORRIES WITH UNDERCOAT

One of the most important factors or features of a good sink is an undercoat that keeps your sink free from unwanted sound, corrosion, and condensation. Royal Series sinks use premium undercoating spray that keeps them dry and efficiently working for the longest time.

CAREFULLY READ THESE INSTRUCTIONS

1. Read the product guide before using it in combination with stainless steel.
2. Before applying the coat directly on the sink, apply on the little part of the sink which is not going to be seen.

A CLEANING GUIDE TO KEEP YOUR SINK FOREVER SHINING AND STYLISH!

Stainless steel utensils get scratched with a brush or scrubber. Over time, they lose their shine. Thus, clean your Sink with a soft sponge or cloth using soap water. Immediately wipe the sink with a dry cloth after a wash to ensure no stains or marks.

Use only good quality washing and cleaning products to clean the sink for its prolonged good performance.