



**THE SCIENTIFIC GLASS FABRICATORS**

**Laboratory Glass Apparatus for  
Education Research & Industry**



+91 9416329204, +61 431324708



Mail: [thescientificglassfabricators@gmail.com](mailto:thescientificglassfabricators@gmail.com)



1440, D. C. Road, Ambala Cantt, - 133001



<http://www.scientificglassfabricator.in>



We are complete laboratory furnishers, selling wide range of Laboratory Products under one roof. We are manufacturers of laboratory glassware, instruments and all kind of consumables. We fulfill different types of industrial requirements for Laboratory Equipments, Cleanroom Products, Laboratory Furniture, Laboratory Consumable like Plasticware, Rubberware, Slicaware, Siliconware Sinteredware, Laboratory Filtration Aids like filter paper, Syringe Filter, Extraction Thimbles etc.

We are having 20 years of expertise in setting up labs in various sectors like Pharmaceuticals, Nutraceuticals, Food & Healthcare Industries, Cosmetic Industries, Paint, Industries, Oil & Refineries, Sugar Industries, Chemical Industries, Soap & Sanitization Industries Paper & Pulp Industries, Cotton & Yarn Industries, Water & Beverages Industries, Plywood & MDF Industries, Perfume & Aeromatic Industries etc.



Be an internationally renowned instruments product trading company known for its excellent customer service though our client relationships and venture in the development of new product lines. Customer satisfaction with best services is our prime vision.



Our future growth will be achieved by helping our customers and suppliers to succeed. We have invested in our people and technology systems to increase our ability to add value to our customers' products as well as solve their complex supply chain issues





**DIGITAL MELTING POINT APP**



**LEAK TEST APP**

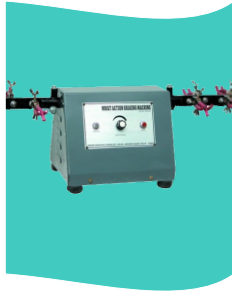

**WRIST ACTION SHAKER**



**P H METER**



**SPECTO PHOTO METER**

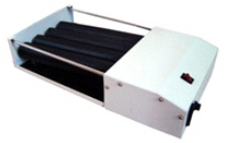

**BLOOD ROLLER MIXER**



**SOXHLET EXTRACTION APPARATUS**



**ELECTRIC BUNSEN BURNER**



**AUTOCLAVES**



**MICROSCOPE**



**ACTOPHOTOMETER**



**AMPOULE FILLING & SEALING MACHINE**



**ANALGASIOMETER**



**ANTIBIOTIC ZONE READER**



**BOTTLE FILLING**



**COATING PAN**



**COOK'S POLE CLIMBING**



**DT SINGLE**



**DOUBLE CONE BLINDER**



**ELECTRO CONVULSOMETER**



**FRIABILITY**



**ROTA ROD**



**TUBE FILLING MACHINE**



**RECORDING DRUM**



**P H, TDS PEN  
TYPE METER**



**HAND  
REFTOMETER**



**P H FAMILY  
TESTOR**



**TDS/ COND  
FAMILY TESTOR**

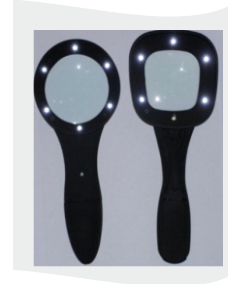

**TORCH  
MAGNIFIER**



**RINGER TIMER**



**STOP WATCH**



**BALANCE**



**H M DIGITAL  
SAFE THERMOMETER**



**INFRALED  
THERMOMETER**



**MULTI STEMP  
THERMOMETER**



**PEN SHAPE  
THERMOMETER**



**THERMO  
HYGRO METER**



**BREATH  
ALCHOL METER**



**BREATH ALCHOL METER  
(DRIVE SAFETY)**



**ULTRA  
SONICATOR**



**POLRIMETER**



**ABHE  
REFTOMETER**

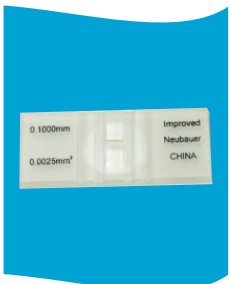

**COUITING  
CHAMBER**



**MOISTURE  
METER**



**STUDENT  
ORGAN BATH**



**TELESCOPE**



**OVEN**



**INCUBATOR**



HEATING MANTLE

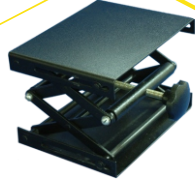

LAB JACK



VACUUM PUMP



ROTARY HIGH VACUUM RIM



MAGNETIC STIRRER



STERILITY TEST UNIT



VACUUM CUM PRESSURE PUMP



CENTRIFUGE MACHINE

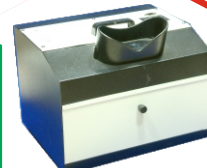

U.V. CABINET



MELTING POINT



VDRL SHAKER



THIN LAYER CHROMATOGRAPHY KIT



LEAK TEST APP.



VORTEX SHAKER



HOT PLATE



DIGITAL PH METER



DIGITAL MELTING POINT APP.



ROTARY VACUUM EVAPORATOR



WRIST ACTION SHAKER



T.D.S. PH PEN TYPE



**MULTICHANNEL MICROPIPETTE**



**VACUUM DESSICATOR**



**S.S HOLDER**



**MEMBRANE GLASS FILTER HOLDER**



**REAGENT BOLLTE**



**MIRCOPIPETTE**



**SILICA WARE**



**AGATE**



**IMPORTED DESSICATOR**



**C.O.D. DIGESTION**



**HOT PLATE**



**ELECTRODES**



**TEST SIEVES**



**SINTERED BUCHNER FUNNEL**



**NICKEL CRUCIBLE**



**TEFLON BEED**



**SINTERED CRUCIBLE**



**HAND REFRACTOMETER**

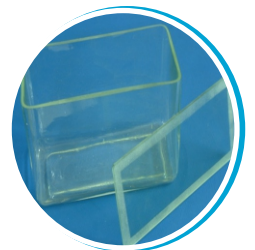

**IMPORTED JAR**



**BURETTE &  
BURETTE CLAMP**

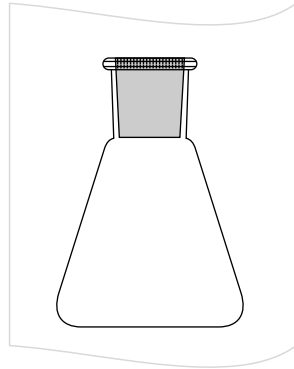

**ERLENMEYER  
FLASK**

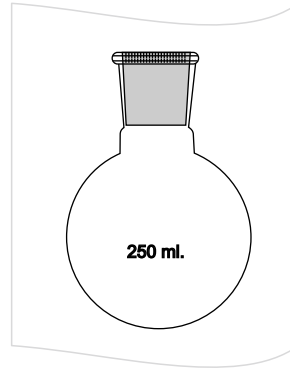

**BOILING ROUND  
BOTTOM FLASK**

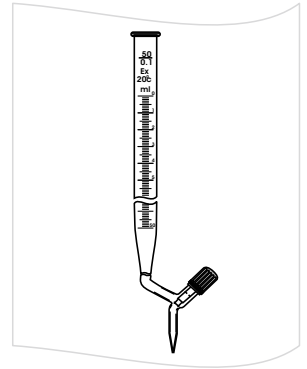

**BURETTE**

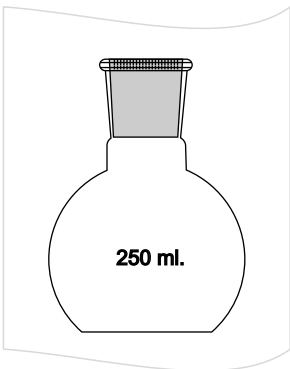

**FLAT  
BOTTOM FLASK**

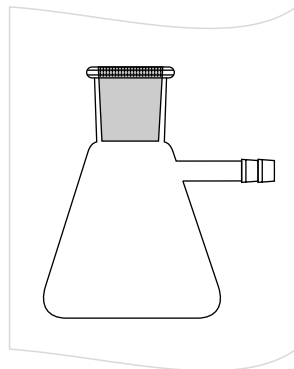

**FILTERING  
FLASK**



**AUTOMATIC  
BURETTE**

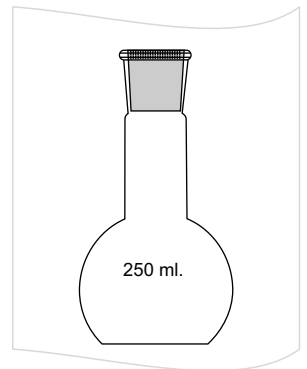

**VOLUMETRIC  
FLASK**



**DISTILLING  
FLASK**



**BOD  
BOTTLES**

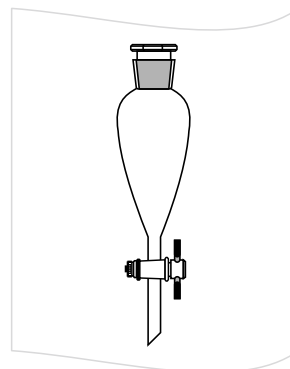

**SEPARATORY  
FUNNEL**

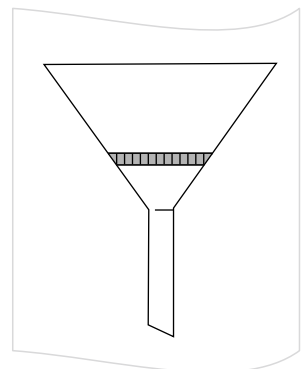

**FUNNELS**



**BUCHNER  
FUNNEL**



**WASH  
BOTTLES**

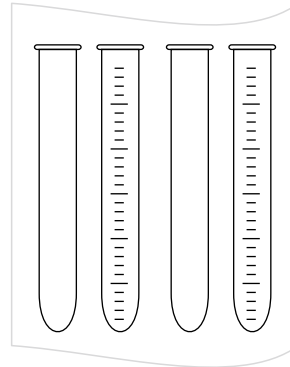

**TEST TUBES**



**DESICCATOR**

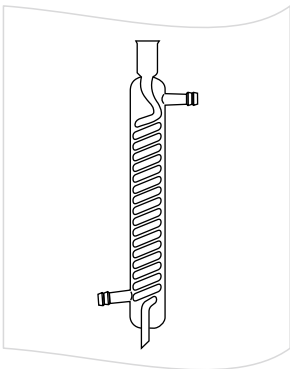

**CONDENSER**

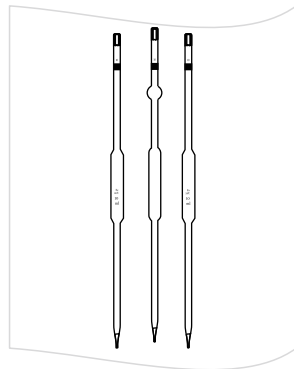

**VOLUMETRIC  
PIPETTES**



**PETRI DISH**

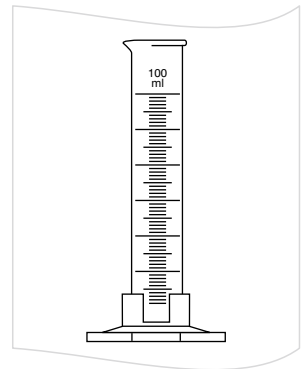

**GRADUATED  
CYLINDERS**



**BEAKER**

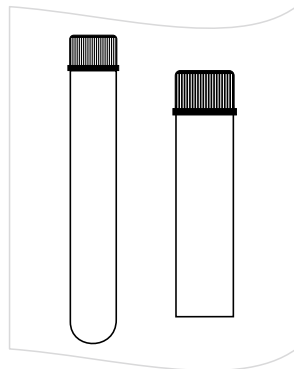

**CULTURE TUBES**

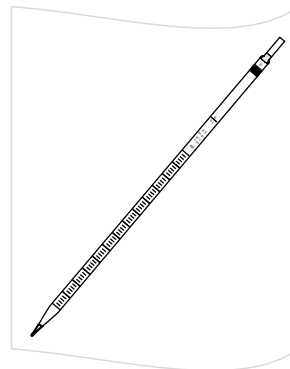

**SEROLOGICAL  
PIPETTES**

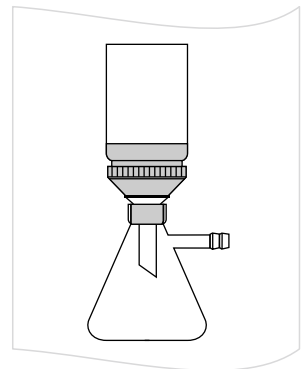

**FILTER FLASK**



## **THE SCIENTIFIC GLASS FABRICATORS**

**Laboratory Glass Apparatus for  
Education Research & Industry**

-  **+91 9416329204, +61 431324708**
-  **Mail: [thescientificglassfabricators@gmail.com](mailto:thescientificglassfabricators@gmail.com)**
-  **1440, D. C. Road, Ambala Cantt, - 133001**
-  **<http://www.scientificglassfabricator.in>**