

AN ISO
9001 : 2008
COMPANY

Translate your dreams
into a **magical** reality

HARTTM
for life time steel

architectural
Hardware
FITTINGS

Delivering Versatile Elements of aesthetics

company Profile

ABOUT US:-

ALFA is leading manufacturer of corrosive resistance high grade AISI 316/304 stainless steel architectural hardware fitting since last many year. Products are manufacturing under the brand name **HART**.

The product range portfolio has a wide range of products offered by us are demanded in the market to their features, design, polish and finish, dimensional accuracy, durability.

Our products are used in worldwide in different projects such as Commercial, Industrial, Domestic and International.

Our organisation is backed by experienced team members. Who helps in understanding the diverse requirement of the client and offering the products accordingly.

INFRASTRUCTURE :-

In our company well equipped modern machinery like as a VMC, CNC, Hydraulic banding machine, Power press, Buffing machine, Cutting machine, Hydraulic press, Manual batch grinder, Lath machine, Thread machine, Drill, Surface batch grinding machine and Round pipe grinding machine, Tig welding machine etc. To produce a better & bulk production. Our total production are "in-house".

QUALITY & MANAGEMENT :-

All of our products are manufacture under one roof following ISO 9001:2008 quality standards.

We manufacture these products by using superior quality raw material which is sources from the reliable vendors. Raw materials are tested on different physical and chemical parameter to ensures their quality.

We having modern machinery to makes process of converting raw materials into finished goods.

During the process we better take care of the products to be its best when process ends. We giving equal importance production expansion as well as pre & post services.

MISSION:-

Our mission is to provide high quality products with reasonable rate, best customer service and the product guarantee. We are trying to provide satisfaction to our each and every customer and dispatch as per commitment.

METHODOLOGY:-

We believe in strong research and development before we launch our products in market. We also gets the valuable opinion from Architectures and Interior designers for better look comfort and style of our product.

VISION:-

Over the years, our company has introduced high quality and latest product range for society to leave the competitors for behind in order to meet the set goal of company. We use constant changing as per market demand and client specified requirements.



Welcome to the range of **HART**™ premium architectural products. Some products are proven and some are fresh & newly developed. The whole new world of selection for the quality and designs you want. And if you still feel customized designs just drop us a word and we will cater to your demand promptly.

INDEX <<<<

Spider Fittings	-	06/17
Canopy Fittings	-	18/21
Glass Door Sliding Folding System	-	22/29
Shower Glass Fittings	-	30/37
Patch Fittings	-	38/41
Mortise Handles	-	42/57
Glass Door Handles	-	58/65
Glass Connectors	-	66/71
Floor Spring & Door Closer	-	72/75



architectural
hardware
FITTINGS

All fittings are designed and manufactured for international safety standards, as we ensure a sturdy facade in most severe conditions in exterior and interior application.

SPIDER FITTINGS



ASF-01

Four way fin type spider
Finish : Satin / Glossy
Material : Stainless steel 316 grade

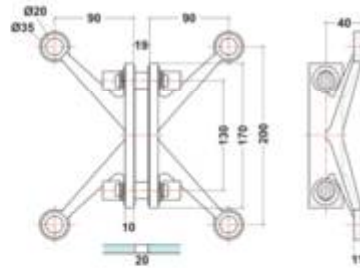

ASF-02

Two way fin type spider
Finish : Satin / Glossy
Material : Stainless steel 316 grade

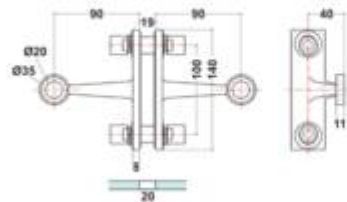

ASF-03

Four way point type spider
Finish : Satin / Glossy
Material : Stainless steel 316 grade

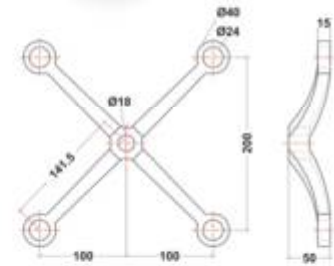

ASF-04

Three way point type spider
Finish : Satin / Glossy
Material : Stainless steel 316 grade

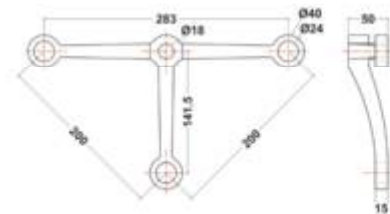

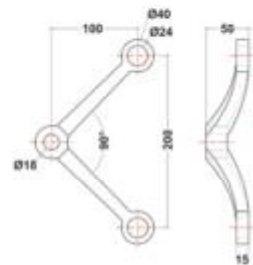

ASF-05

Two way point type spider 90°
Finish : Satin / Glossy
Material : Stainless steel 316 grade

ASF-06

Two way point type spider 180°
Finish : Satin / Glossy
Material : Stainless steel 316 grade

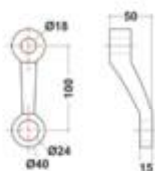
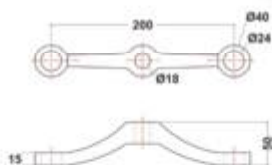

ASF-07

One way point type spider
Finish : Satin / Glossy
Material : Stainless steel 316 grade

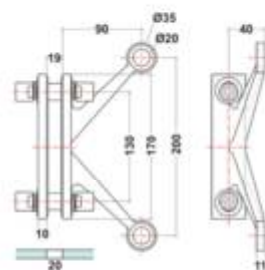

ASF-08

Two way fin type spider 90°
Finish : Satin / Glossy
Material : Stainless steel 316 grade

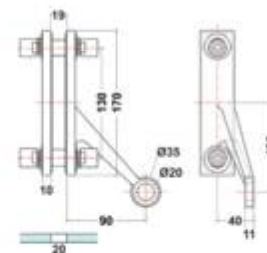

ASF-09

One way fin type spider right side 45°
Finish : Satin / Glossy
Material : Stainless steel 316 grade

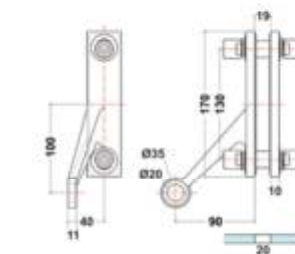

ASF-10

One way fin type spider left side 45°
Finish : Satin / Glossy
Material : Stainless steel 316 grade



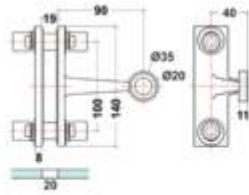

ASF-11

One way fin type spider 90°
Finish : Satin / Glossy
Material : Stainless steel 316 grade

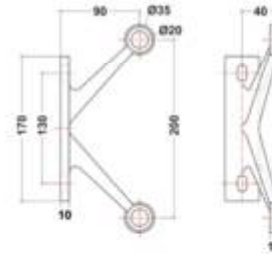

ASF-13

Two way spider
Finish : Satin / Glossy
Material : Stainless steel 316 grade



ASF-12

Four way spider 90°
Finish : Satin / Glossy
Material : Stainless steel 316 grade

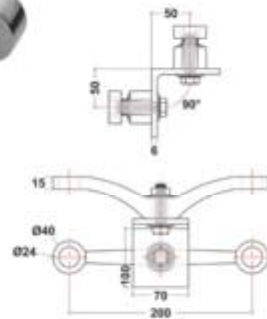

ASF-14

One way spider
Finish : Satin / Glossy
Material : Stainless steel 316 grade

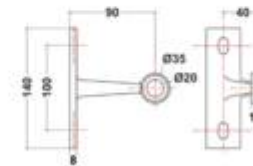

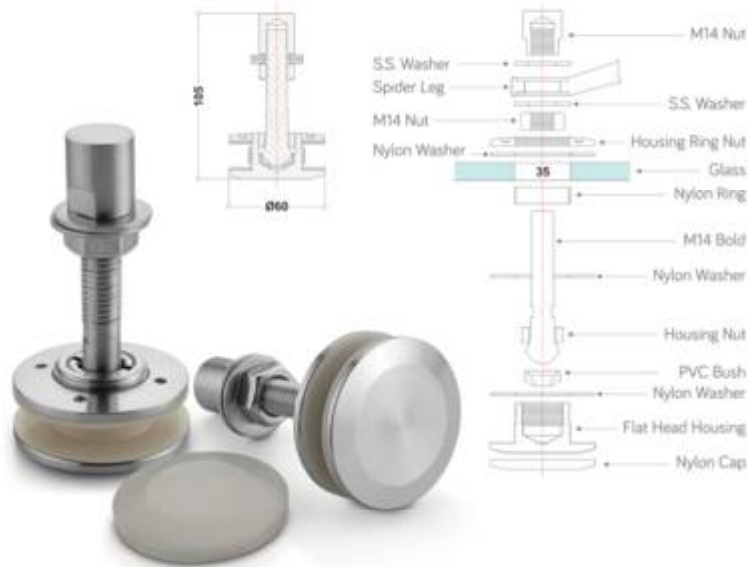

ARF-01

Articated roulet
Finish : Satin / Glossy
Material : Stainless steel 304 grade



ARF-02

Articated roulet
Finish : Satin / Glossy
Material : Stainless steel 304 grade



ARF-03

Fix head roulet
Finish : Satin / Glossy
Material : Stainless steel 304 grade

ARF-04
Fix head roulet
Finish : Satin / Glossy
Material : Stainless steel 304 grade



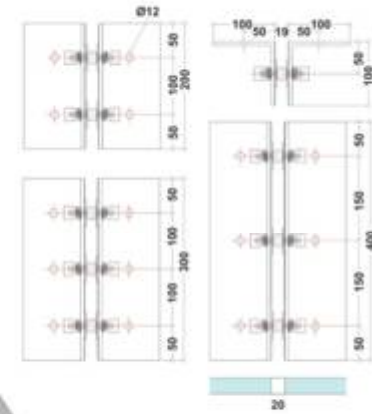
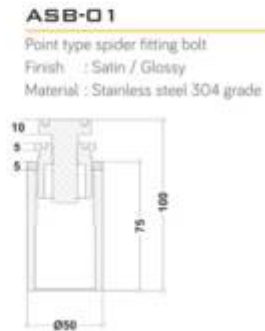
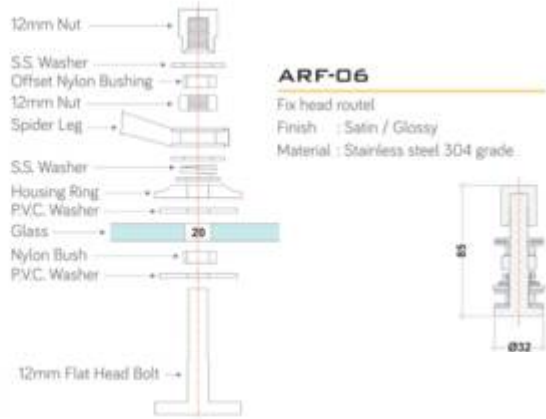
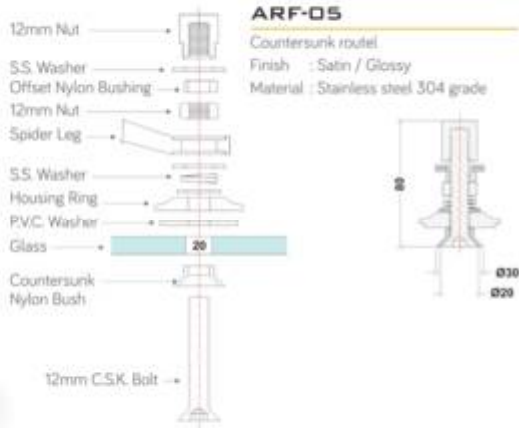

AFP-01
Fin plate
Finish : Satin / Glossy
Material : Stainless steel 304 grade

ASP-01
Splice plate
Finish : Satin / Glossy
Material : Stainless steel 304 grade

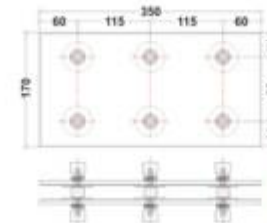
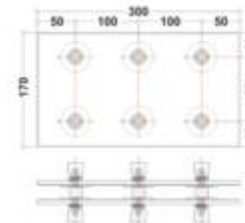
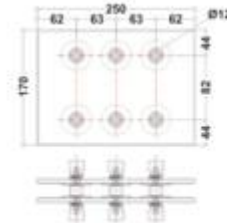



We are manufacture huge range of canopy fitting that are designed for high performance. These can resist wind as well as other climate conditions.

CANOPY FITTINGS

ACF-01

Hold glass with the wall at 90°
 Finish : Satin / Glossy
 Material : Stainless steel 304 grade

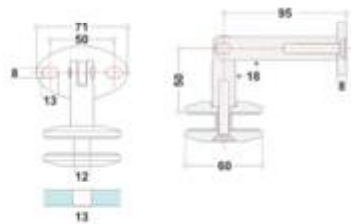

ACF-02

Hold canopy glass with cable or rod along with ACF-03
 Finish : Satin / Glossy
 Material : Stainless steel 304 grade

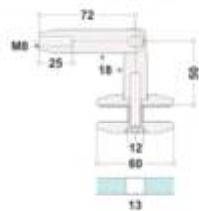

ACF-03

Hold the cable or rod with the wall be used as a pair with ACF-02
 Finish : Satin / Glossy
 Material : Stainless steel 304 grade

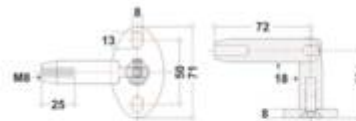

ACF-04

Hold glass for canopy with cable or rod with ACF-05
 Finish : Satin / Glossy
 Material : Stainless steel 304 grade



ACF-05

Hold the cable or rod with the wall be used as a pair with ACF-04
 Finish : Satin / Glossy
 Material : Stainless steel 304 grade

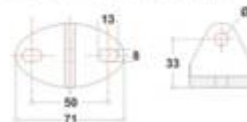

Add a new class to the glass while enriching the ambience
by a few thousand notes of melodious grace.

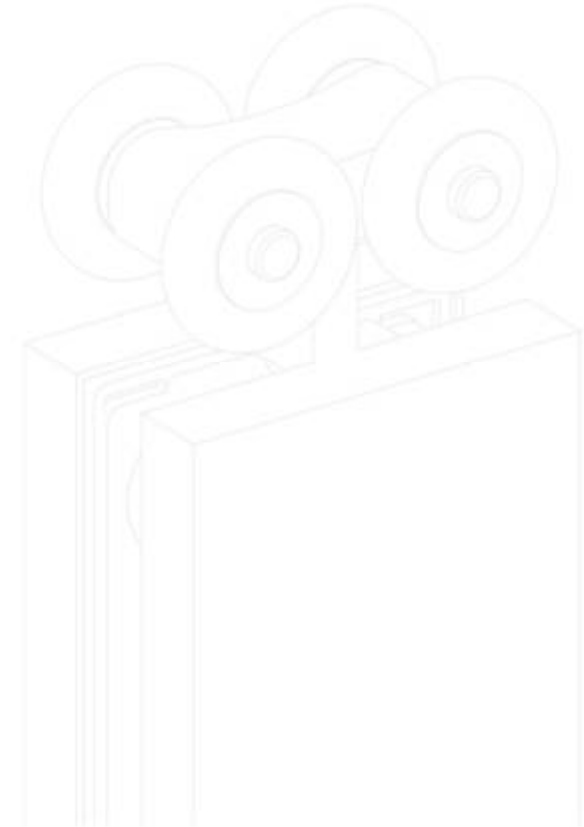

GLASS DOOR SLIDING FOLDING SYSTEM

GLASS CENTER FOLDING SYSTEM

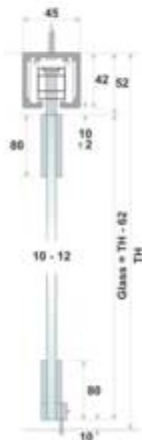
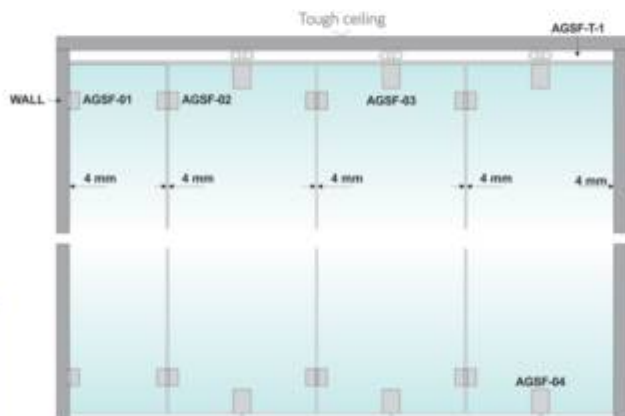

Start panel with top and bottom wall to glass hinge	Folding panel with top - bottom roller and connected hinge device	Folding panel with top - bottom roller and connected hinge device	Folding panel with top - bottom roller and connected hinge device
Door width : Folding Door/2	800mm	800mm	800mm

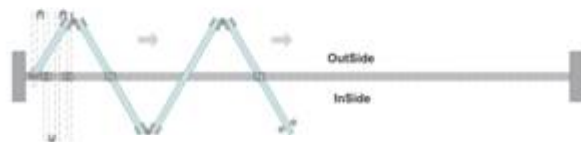

Calculation of glass weight :

Thickness of glass	Approx weight Per Sq. Ft.
6mm	1.400 kg
8mm	1.900 kg
10mm	2.400 kg
12mm	2.900 kg



Features :

- Advanced glass center folding mechanism for up to 6 frame less glass panels with professional design concept.
- Center folding system is designed for both interior and exterior applications.
- Panels are connected using a hinges system
- Nylon wheels integrated bearing for quite easy running
- Maximum weight of door : 75kgs/Panel
- Minimum Panel Width : 500mm



AGSF-01

Wall to glass connecting hinges
Finish : Satin
Material : Stainless Steel 304 Grade

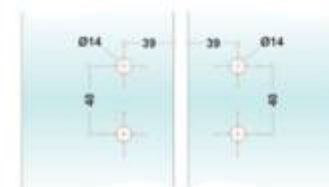
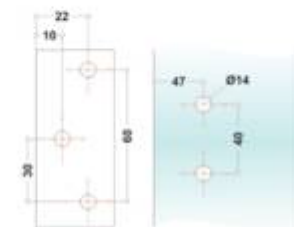

AGSF-02

Glass to glass interconnecting hinges
Finish : Satin
Material : Stainless Steel 304 Grade



AGSF-03

Glass sliding door roller
(Use : Track code AGSF-T-1)
Finish : Satin
Material : Stainless Steel 304 Grade

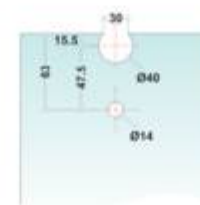

AGSF-04

Push bottom lock
Finish : Satin
Material : Stainless Steel 304 Grade

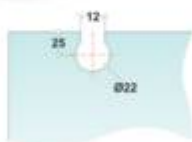

AGSF-R-1

Glass sliding door roller for 10 to 12mm glass
(Use : Track code AGSF-T-2)

Finish : Satin

Material : Stainless Steel 304 Grade

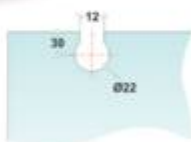

AGSF-R-2

Glass sliding door roller for 10 to 12mm glass
(Use : Track code AGSF-T-2)

Finish : Satin

Material : Stainless Steel 304 Grade

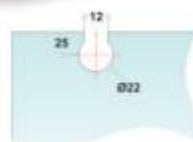

AGSF-R-5

Glass sliding door roller for 10 to 12mm glass
(Use : Track code AGSF-T-3 / T-4 / T-5)

Finish : Satin

Material : Stainless Steel 304 Grade

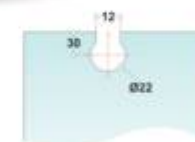

AGSF-R-6

Glass sliding door roller for 10 to 12mm glass
(Use : Track code AGSF-T-3 / T-4 / T-5)

Finish : Satin

Material : Stainless Steel 304 Grade

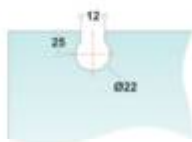

AGSF-R-3

Glass sliding door roller for 10 to 12mm glass
(Use : Track code AGSF-T-2)

Finish : Satin

Material : Stainless Steel 304 Grade

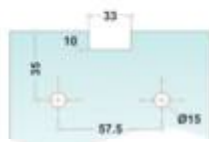

AGSF-R-4

Glass sliding door roller for 10 to 12mm glass
(Use : Track code AGSF-T-2)

Finish : Satin

Material : Stainless Steel 304 Grade

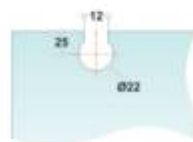

AGSF-R-7

Glass sliding door roller for 10 to 12mm glass
(Use : Track code AGSF-T-3 / T-4 / T-5)

Finish : Satin

Material : Stainless Steel 304 Grade

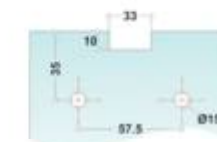

AGSF-R-8

Glass sliding door roller for 10 to 12mm glass
(Use : Track code AGSF-T-3 / T-4 / T-5)

Finish : Satin

Material : Stainless Steel 304 Grade



AGSF-T-1

Top track
Material : Aluminium anodize



AGSF-T-2

Top track
Material : Aluminium anodize



AGSF-T-3

Top track for only door
Material : Aluminium anodize



AGSF-T-4

Top track for double doors
Material : Aluminium anodize

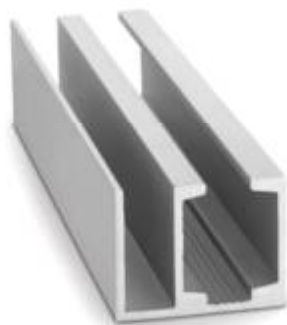

AGSF-T-5

Top track for door & fixed glass
Material : Aluminium anodize



ADS-01

Door stopper
Finish : Satin / Glossy
Material : Stainless Steel 304 Grade



AFG-01

Floor guide
Finish : Satin / Glossy
Material : Stainless Steel 304 Grade



A-1

Track mounting bracket wall to track fixer
Finish : Satin / Glossy
Material : Stainless Steel 304 Grade



A-2

Wall to track connector
Material : PVC solid (white)



A-3

Door stopper
(Use : Roller code AGSF-R-1 to R-4)
Material : PVC solid (white)



A-4

Door stopper
(Use : Roller code AGSF-R-5 to R-8)
Material : PVC solid (white)

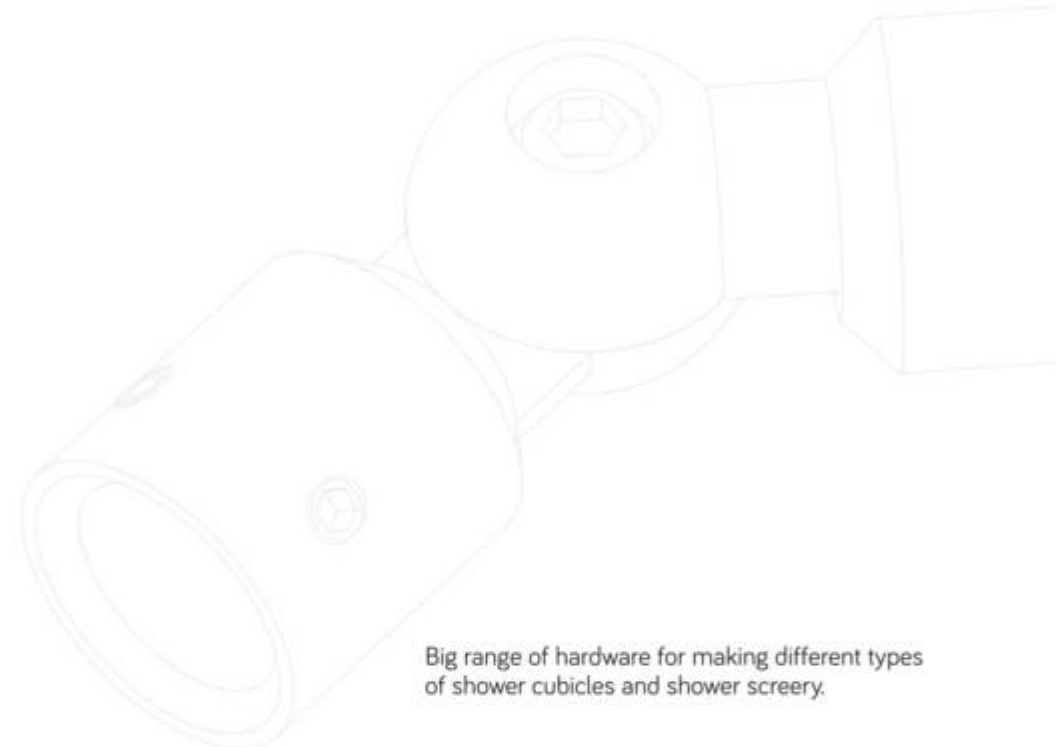

Big range of hardware for making different types of shower cubicles and shower screeny.

SHOWER GLASS FITTINGS



ASDH-01

Glass sliding rectangle door handle
 Finish : Satin / Glossy
 Material : Stainless steel 304 grade

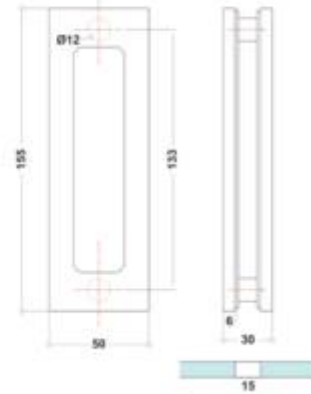

ASDH-02

Glass sliding rectangle door handle
 Finish : Satin / Glossy
 Material : Stainless steel 304 grade

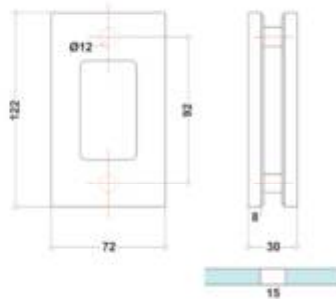

ASDH-03

Glass sliding rectangle door handle
 Finish : Satin / Glossy
 Material : Stainless steel 304 grade

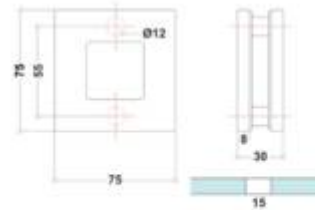

ASDH-04

Glass sliding round door handle
 Finish : Satin / Glossy
 Material : Stainless steel 304 grade

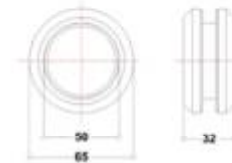

ASDH-05

Glass sliding round door handle
 Finish : Satin / Glossy
 Material : Stainless steel 304 grade

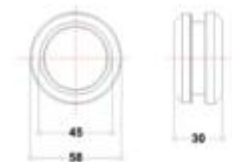

**ASGF-01**

Rod to wall connector for Ø19mm rod
Finish : Satin / Glossy
Material : Stainless Steel 304 Grade

**ASGF-02**

Rod to glass support connector for Ø19mm rod
Finish : Satin / Glossy
Material : Stainless Steel 304 Grade

**ASGF-03**

Top rod to glass connector for Ø19mm rod
Finish : Satin / Glossy
Material : Stainless Steel 304 Grade

**ASGF-04**

Support clamp for
two way connecting rod for Ø19mm tube
Finish : Satin / Glossy
Material : Stainless Steel 304 Grade

**ASGF-05**

Support clamp for
three way connecting rod for Ø19mm tube
Finish : Satin / Glossy
Material : Stainless Steel 304 Grade

**ASGF-06**

Round Track Ø19mm tube
Finish : Satin / Glossy
Material : Stainless Steel 304 Grade

**ASGF-07**

Wall to track connector
Finish : Satin / Glossy
Material : Stainless Steel 304 Grade

**ASGF-08**

Track to glass connector
Finish : Satin / Glossy
Material : Stainless Steel 304 Grade

**ASGF-09**

Track to track connector 90°
Glass to track end connector
Finish : Satin / Glossy
Material : Stainless Steel 304 Grade

**ASGF-10**

Reinforcing Track 10x30mm
Finish : Satin / Glossy
Material : Stainless Steel 304 Grade



ASGK-01

Shower door knob
Finish : Satin / Glossy
Material : Stainless Steel 304 Grade



ASGK-02

Shower door knob
Finish : Satin / Glossy
Material : Stainless Steel 304 Grade



ASGK-03

Shower door knob
Finish : Satin / Glossy
Material : Stainless Steel 304 Grade



ATB-01

Shower glass door handle - round
(Ø19mm pipe / Ø22mm pipe / Ø25mm pipe)
Finish : Satin / Glossy
Material : Stainless Steel 304 Grade



ATB-02

Shower glass door handle - square
(Ø 20mm pipe / Ø 25mm pipe)
Finish : Satin / Glossy
Material : Stainless Steel 304 Grade



A-R-01

Railing fitting Julia
Finish : Satin / Glossy
Material : Stainless steel 304 grade



A-R-02

Railing fitting pipe to glass - Solid casted
Finish : Satin / Glossy
Material : Stainless steel 304 grade



A-R-03

Railing fitting pipe to glass - Solid
Finish : Satin / Glossy
Material : Stainless steel 304 grade



A-R-04

Railing fitting - Solid
Finish : Satin / Glossy
Material : Stainless steel 304 grade

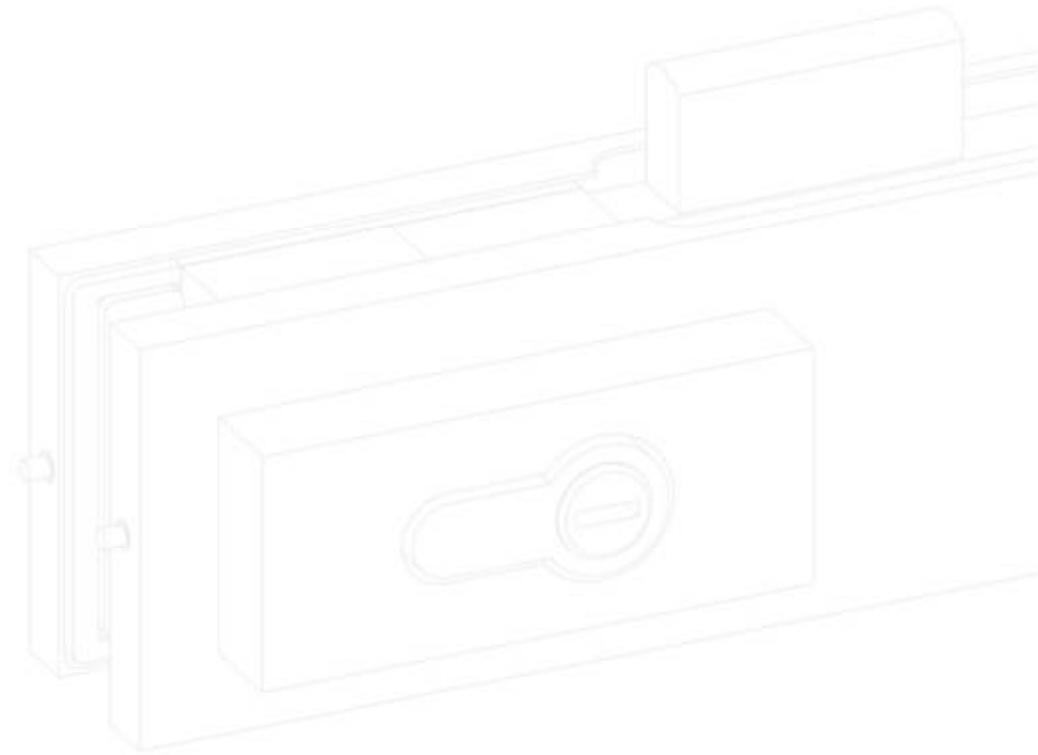

Making things smooth in the life and better usability is exact need cotteder by us.

PATCH FITTINGS



APF-01

Top patch
Finish : Satin
Material : Aluminium alloy body & stainless steel 304 grade cover plate



APF-02

Bottom patch
Finish : Satin
Material : Aluminium alloy body & stainless steel 304 grade cover plate

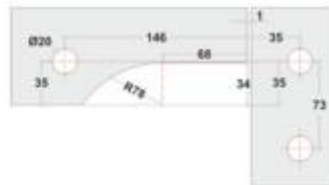

APF-03

Over panel side panel patch with pivot (Big 'L')
Finish : Satin
Material : Aluminium alloy body & stainless steel 304 grade cover plate



APF-04

Aluminium fixed floor
Finish : Satin
Material : Aluminium alloy body & stainless steel 304 grade cover plate

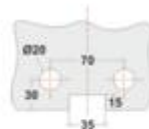

APF-05

Glass to glass aluminium fixed floor
Finish : Satin
Material : Aluminium alloy body & stainless steel 304 grade cover plate

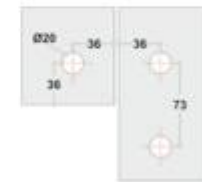

APF-06

Over panel side panel patch (Small 'L')
Finish : Satin
Material : Aluminium alloy body & stainless steel 304 grade cover plate



APF-07

Over panel patch with pivot & wall
Finish : Satin
Material : Aluminium alloy body & stainless steel 304 grade cover plate

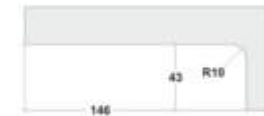

APF-08

Patch lock
Finish : Satin
Material : Aluminium alloy body & stainless steel 304 grade cover plate



APF-09

Bottom bearing patch pivot
Finish : Satin
Material : Stainless steel 304 grade & M.S



APF-10

Top patch pivot
Finish : Satin
Material : Stainless steel 304 grade



architectural
hardware
FITTINGS

Time less designs and
elegance for better life
style and proper
functionality.

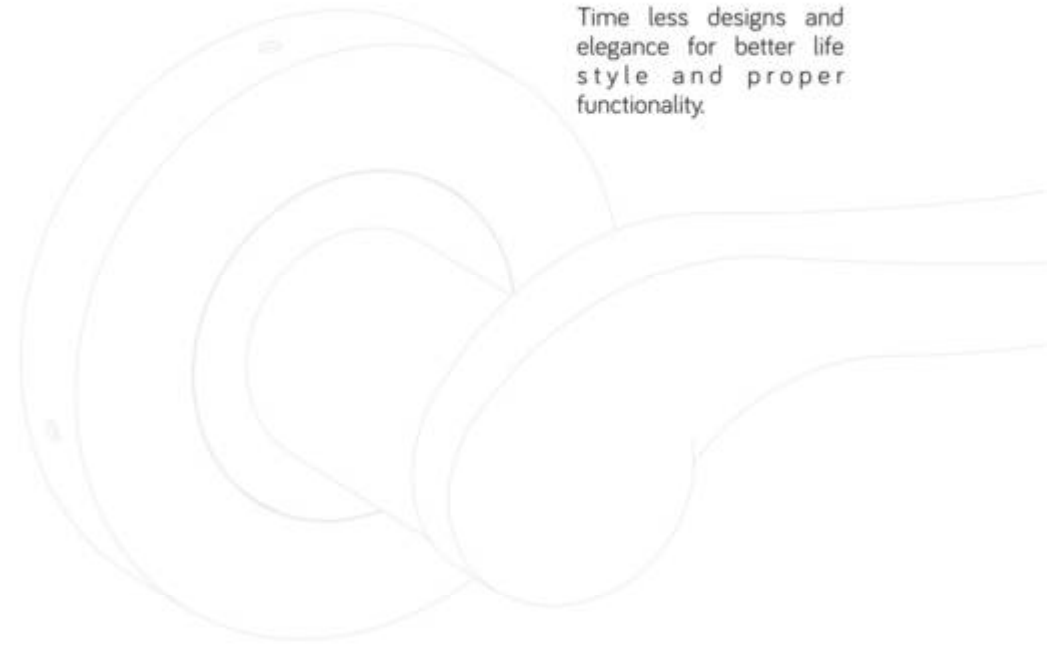

MORTISE HANDLES



AMH-01

Mortise handle 19mm & 22mm round pipe
Finish : Satin / Glossy
Material : Stainless steel 304 grade
(Also available in plate type mortise)



AMH-02

Mortise handle 19mm & 22mm round pipe
Finish : Satin / Glossy
Material : Stainless steel 304 grade
(Also available in plate type mortise)



AMH-03

Mortise handle 19mm & 22mm round pipe
Finish : Satin / Glossy
Material : Stainless steel 304 grade
(Also available in plate type mortise)



AMH-04

Mortise handle 22mm round pipe
Finish : Satin / Glossy
Material : Stainless steel 304 grade
(Also available in plate type mortise)



AMH-05

Mortise handle 19mm round pipe & solid casted
Finish : Satin / Glossy
Material : Stainless steel 304 grade
(Also available in plate type mortise)



AMH-06

Mortise handle solid casted
Finish : Satin / Glossy
Material : Stainless steel 304 grade
(Also available in plate type mortise)



AMH-07

Mortise handle solid casted
Finish : Satin / Glossy
Material : Stainless steel 304 grade
(Also available in plate type mortise)



AMH-08

Mortise handle solid casted
Finish : Satin / Glossy
Material : Stainless steel 304 grade
(Also available in plate type mortise)

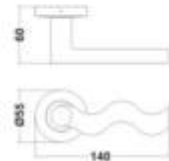

AMH-09

Mortise handle solid casted
Finish : Satin / Glossy
Material : Stainless steel 304 grade
(Also available in plate type mortise)

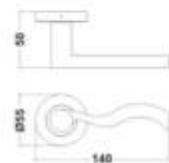

AMH-10

Mortise handle solid casted
Finish : Satin / Glossy
Material : Stainless steel 304 grade
(Also available in plate type mortise)

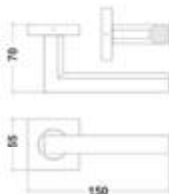

AMH-11

Mortise handle solid casted
Finish : Satin / Glossy
Material : Stainless steel 304 grade
(Also available in plate type mortise)

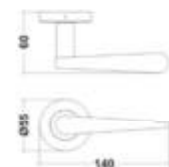

AMH-12

Mortise handle solid casted
Finish : Satin / Glossy
Material : Stainless steel 304 grade
(Also available in plate type mortise)

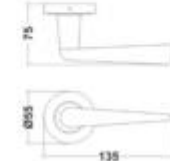

AMH-13

Mortise handle solid casted
Finish : Satin / Glossy
Material : Stainless steel 304 grade
(Also available in plate type mortise)

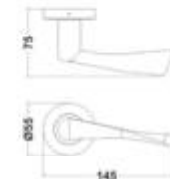

AMH-14

Mortise handle solid casted
Finish : Satin / Glossy
Material : Stainless steel 304 grade
(Also available in plate type mortise)

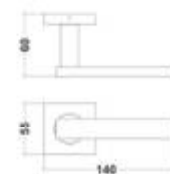

AMH-15

Mortise handle solid
Finish : Satin / Glossy
Material : Stainless steel 304 grade
(Also available in plate type mortise)

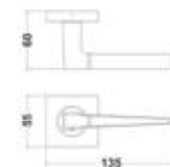

AMH-16

Mortise handle solid casted
Finish : Satin / Glossy
Material : Stainless steel 304 grade
(Also available in plate type mortise)

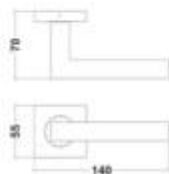

AMH-17

Mortise handle 20mm square pipe
Finish : Satin / Glossy
Material : Stainless steel 304 grade
(Also available in plate type mortise)

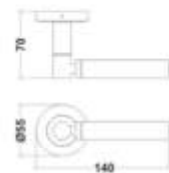

AMH-18

Mortise handle 19mm round pipe
Finish : Satin / Glossy
Material : Stainless steel 304 grade
(Also available in plate type mortise)



AMH-19

Mortise handle
Finish : Satin / Glossy
Material : Stainless steel 304 grade
(Also available in plate type mortise)

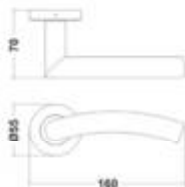

AMH-20

Mortise handle 22mm round pipe
Finish : Satin / Glossy
Material : Stainless steel 304 grade
(Also available in plate type mortise)

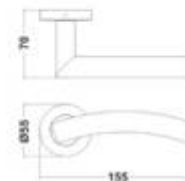

AMH-21

Mortise handle 22mm round pipe
Finish : Satin / Glossy
Material : Stainless steel 304 grade
(Also available in plate type mortise)

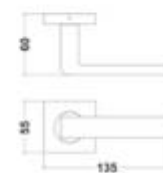

AMH-22

Mortise handle solid
Finish : Satin / Glossy
Material : Stainless steel 304 grade
(Also available in plate type mortise)

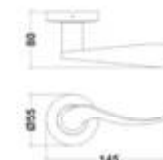

AMH-23

Mortise handle solid casted
Finish : Satin / Glossy
Material : Stainless steel 304 grade
(Also available in plate type mortise)

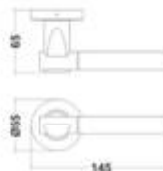

AMH-24

Mortise handle solid casted & 19mm round pipe
Finish : Satin / Glossy
Material : Stainless steel 304 grade
(Also available in plate type mortise)

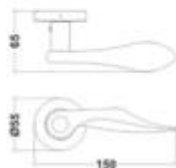

AMH-25

Mortise handle solid casted
Finish : Satin / Glossy
Material : Stainless steel 304 grade
(Also available in plate type mortise)

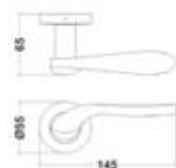

AMH-26

Mortise handle solid casted
Finish : Satin / Glossy
Material : Stainless steel 304 grade
(Also available in plate type mortise)

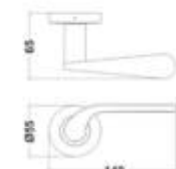

AMH-27

Mortise handle solid casted
Finish : Satin / Glossy
Material : Stainless steel 304 grade
(Also available in plate type mortise)

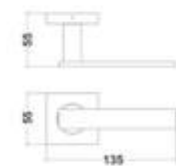

AMH-28

Mortise handle solid & 20mm square pipe
Finish : Satin / Glossy
Material : Stainless steel 304 grade
(Also available in plate type mortise)

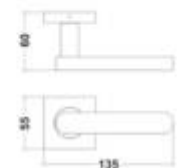

AMH-29

Mortise handle solid
Finish : Satin / Glossy
Material : Stainless steel 304 grade
(Also available in plate type mortise)

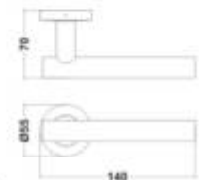

AMH-30

Mortise handle 22mm round pipe
Finish : Satin / Glossy
Material : Stainless steel 304 grade
(Also available in plate type mortise)

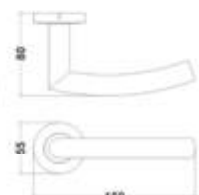

AMH-31

Mortise handle 22mm round pipe
Finish : Satin / Glossy
Material : Stainless steel 304 grade
(Also available in plate type mortise)

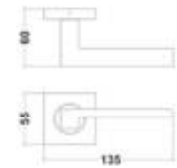

AMH-32

Mortise handle solid
Finish : Satin / Glossy
Material : Stainless steel 304 grade
(Also available in plate type mortise)

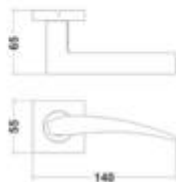

AMH-33

Mortise handle solid casted
Finish : Satin / Glossy
Material : Stainless steel 304 grade
(Also available in plate type mortise)

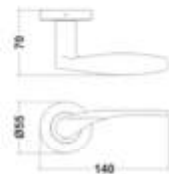

AMH-34

Mortise handle solid casted
Finish : Satin / Glossy
Material : Stainless steel 304 grade
(Also available in plate type mortise)

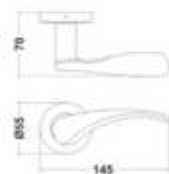

AMH-35

Mortise handle solid casted
Finish : Satin / Glossy
Material : Stainless steel 304 grade
(Also available in plate type mortise)

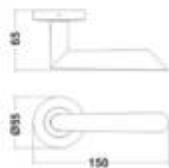

AMH-36

Mortise handle solid casted
Finish : Satin / Glossy
Material : Stainless steel 304 grade
(Also available in plate type mortise)

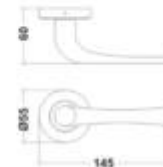

AMH-37

Mortise handle solid casted
Finish : Satin / Glossy
Material : Stainless steel 304 grade
(Also available in plate type mortise)

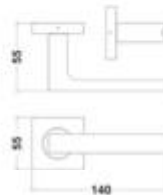

AMH-38

Mortise handle solid casted
Finish : Satin / Glossy
Material : Stainless steel 304 grade
(Also available in plate type mortise)

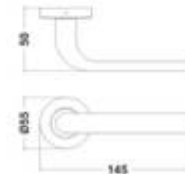

AMH-39

Mortise handle solid casted
Finish : Satin / Glossy
Material : Stainless steel 304 grade
(Also available in plate type mortise)

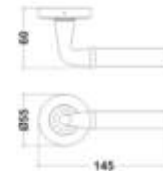

AMH-40

Mortise handle solid casted
Finish : Satin / Glossy
Material : Stainless steel 304 grade
(Also available in plate type mortise)

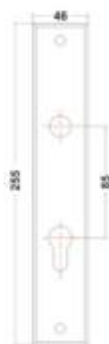

AMH-01-P

Mortise handle with plate solid casted
Finish : Satin / Glossy
Material : Stainless steel 304 grade



AMH-02-P

Mortise handle with plate
Finish : Satin / Glossy
Material : Stainless steel 304 grade



AMH-03-P

Mortise handle with plate
Finish : Satin / Glossy
Material : Stainless steel 304 grade

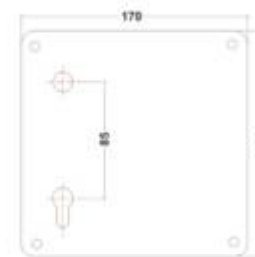

AMH-04-P

Mortise handle with plate
Finish : Satin / Glossy
Material : Stainless steel 304 grade



AML-01

Mortise lock body with strike plate for wood door applied with mortise & cylinder
Finish : Satin / Black



Close Body



Stainless steel plate
avoid rusting



Brass part for
durability



Brass part for
durability



AML-02

Mortise dead lock with strike plate for wood door applied with cylinder
Finish : Satin / Black



AML-03

Mortise baby latch with strike plate for wood door applied with cylinder
Finish : Satin / Black



AKH-01

Round key hole
Finish : Satin / Glossy
Material : Stainless steel 304 grade



AKH-02

Square key hole
Finish : Satin / Glossy
Material : Stainless steel 304 grade



AMC-01

Both side key cylinder with key



AMC-02

One side key & one side knob cylinder with key



AMC-03

One side knob & one side screwdriver part



AMC-04

Half cylinder one side knob only

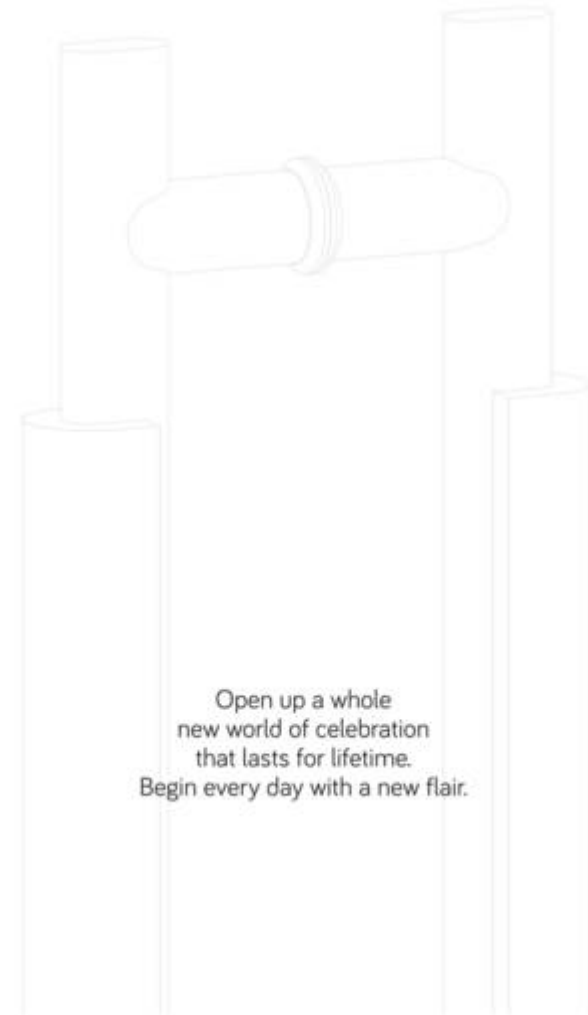

Open up a whole
new world of celebration
that lasts for lifetime.
Begin every day with a new flair.

GLASS DOOR HANDLES

**APH-01**

Glass door handle
 Ø22mm pipe
 Finish : Satin / Combi
 Material : Stainless steel 304 grade

**APH-02**

H-type glass door handle
 Ø22mm / Ø25mm / Ø32mm pipe
 Finish : Satin / Combi
 Material : Stainless steel 304 grade

**APH-05**

Glass door handle
 Finish : Satin
 Material : Stainless steel 304 grade

**APH-06**

D-type glass door handle
 Ø22mm / Ø25mm / Ø32mm pipe
 Finish : Satin / Combi
 Material : Stainless steel 304 grade

**APH-03**

Glass door handle
 Ø19mm / Ø22mm pipe
 Finish : Satin
 Material : Stainless steel 304 grade

**APH-04**

Glass door handle
 170mm x 170mm plate
 Finish : Satin
 Material : Stainless steel 304 grade

**APH-07**

S-type glass door handle
 Ø22mm pipe
 Finish : Satin / Combi
 Material : Stainless steel 304 grade

**APH-08**

C-type glass door handle
 Ø22mm pipe
 Finish : Satin / Combi
 Material : Stainless steel 304 grade

**APH-09**

Glass door handle
 Ø19mm pipe & solid casted
 Finish : Satin / Combi
 Material : Stainless steel 304 grade

**APH-10**

Glass door handle square
 20mm / 25mm pipe
 Finish : Satin / Combi
 Material : Stainless steel 304 grade

**APH-11**

Glass door handle
 Ø22mm pipe
 Finish : Satin / Combi
 Material : Stainless steel 304 grade

**APH-12**

Glass door handle
 Ø22mm / Ø25mm pipe
 Finish : Satin / Combi
 Material : Stainless steel 304 grade

**APH-13**

H-type square glass door handle
 20mm / 25mm pipe
 Finish : Satin / Combi
 Material : Stainless steel 304 grade

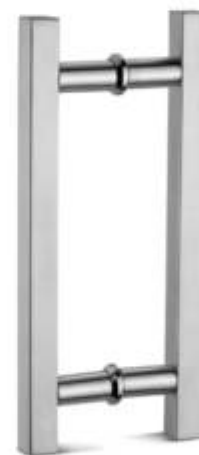
**APH-14**

Glass door handle
 20mm / 25mm pipe
 Finish : Satin / Combi
 Material : Stainless steel 304 grade

**APH-15**

Glass door handle
 15x30 pipe
 Finish : Satin / Combi
 Material : Stainless steel 304 grade

**APH-16**

Glass door handle
 2 pipe
 Finish : Satin / Combi
 Material : Stainless steel 304 grade

**APH-17**

H-type adjustable glass door handle
Ø25mm pipe
Finish : Satin / Combi
Material : Stainless steel 304 grade

**APH-18**

Glass door handle
Ø25mm pipe
Finish : Satin / Combi
Material : Stainless steel 304 grade

**APH-19**

Glass door handle
10x20 Solid
Finish : Satin / Combi
Material : Stainless Steel 304 Grade

**APH-20**

Glass door handle with wood
Finish : Satin / Glossy
Material : Stainless steel 304 grade & wooden

**APH-21**

Glass door handle with wood
Finish : Satin / Glossy
Material : Stainless steel 304 grade & wooden



Wide range of glass connectors for different applications and designs. Press fitting and elegant look are our design philosophy.

GLASS CONNECTORS

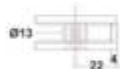

AGC-01

Fixed floor mounting - Casting
Finish : Satin / Glossy
Material : Stainless steel 304 grade

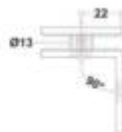

AGC-02

Wall to glass connector 90° - Casting
Finish : Satin / Glossy
Material : Stainless steel 304 grade

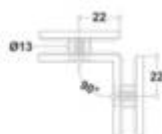

AGC-03

Glass to glass connector 90° - Casting
Finish : Satin / Glossy
Material : Stainless steel 304 grade

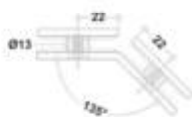

AGC-04

Glass to glass connector 135° - Casting
Finish : Satin / Glossy
Material : Stainless steel 304 grade



AGC-05

Glass to glass connector 180° - Casting
Finish : Satin / Glossy
Material : Stainless steel 304 grade



AGC-06

Fixed floor mounting
4mm sheet metal
Finish : Satin / Glossy
Material : Stainless steel 304 grade

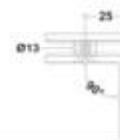

AGC-07

Wall to glass connector 90°
4mm sheet metal
Finish : Satin / Glossy
Material : Stainless steel 304 grade

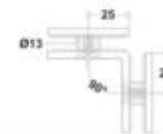

AGC-08

Glass to glass connector 90°
4mm sheet metal
Finish : Satin / Glossy
Material : Stainless steel 304 grade

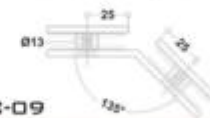

AGC-09

Glass to glass connector 135°
4mm sheet metal
Finish : Satin / Glossy
Material : Stainless steel 304 grade

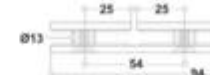

AGC-10

Glass to glass connector 180°
4mm sheet metal
Finish : Satin / Glossy
Material : Stainless steel 304 grade

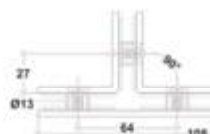

AGC-11

Glass to glass connector three way 90°
4mm sheet metal
Finish : Satin / Glossy
Material : Stainless steel 304 grade



AGC-12

Fixed floor mounting
3mm sheet metal
Finish : Satin / Glossy
Material : Stainless steel 304 grade



AGC-13

Wall to glass connector 90°
3mm sheet metal
Finish : Satin / Glossy
Material : Stainless steel 304 grade



AGC-14

Glass to glass connector 90°
3mm sheet metal
Finish : Satin / Glossy
Material : Stainless steel 304 grade

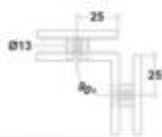

AGC-15

Glass to glass connector 135°
3mm sheet metal
Finish : Satin / Glossy
Material : Stainless steel 304 grade

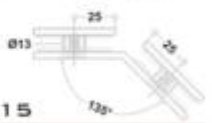

AGC-16

Glass to glass connector 180°
3mm sheet metal
Finish : Satin / Glossy
Material : Stainless steel 304 grade



AGC-17

Glass to glass connector three way 90°
3mm sheet metal
Finish : Satin / Glossy
Material : Stainless steel 304 grade

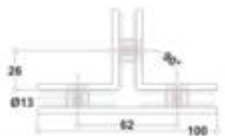

AGC-18

Fix bracket wall to glass 90°
Finish : Satin / Glossy
Material : Stainless steel 304 grade



AGC-19

Square glass center button
Finish : Satin / Glossy
Material : Stainless steel 304 grade

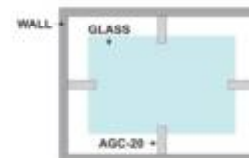

AGC-20

Glass center
Finish : Satin / Glossy
Material : Stainless steel 304 grade



AGH-01

Glass to glass hinge without spring action for 6mm & 8mm
Finish : Satin / Glossy
Material : Stainless steel 304 grade



AGH-02

Wall to glass hinge without spring action for 6mm & 8mm
Finish : Satin / Glossy
Material : Stainless steel 304 grade



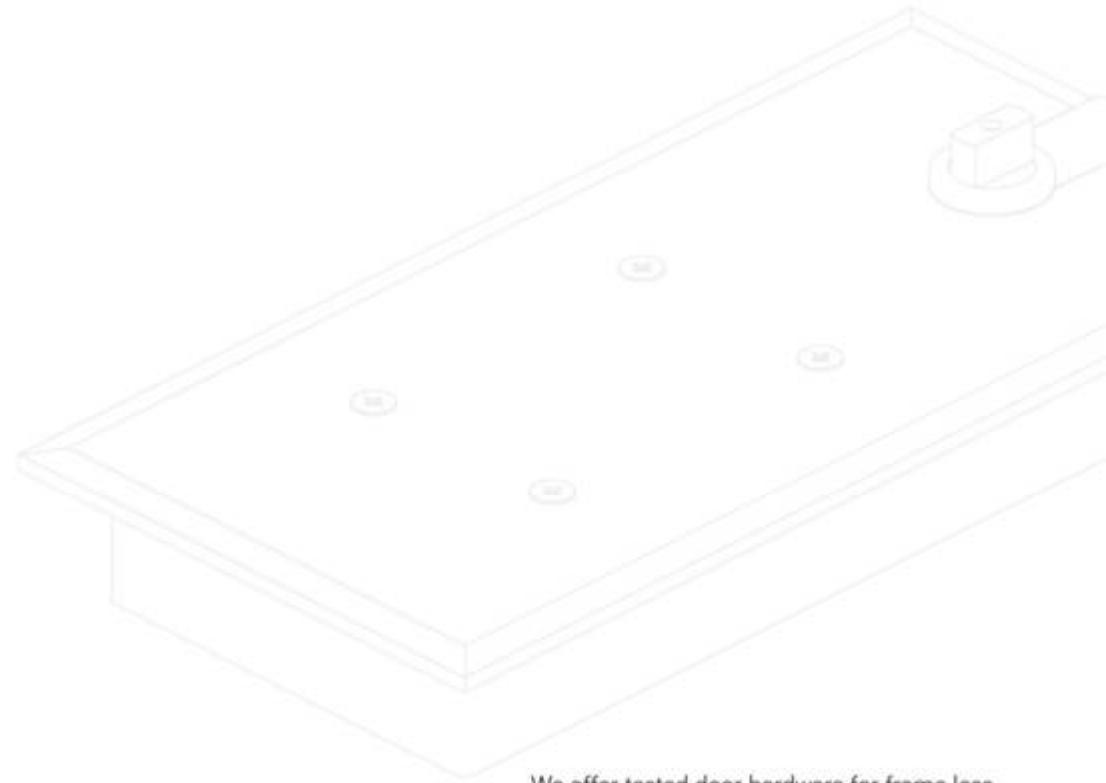
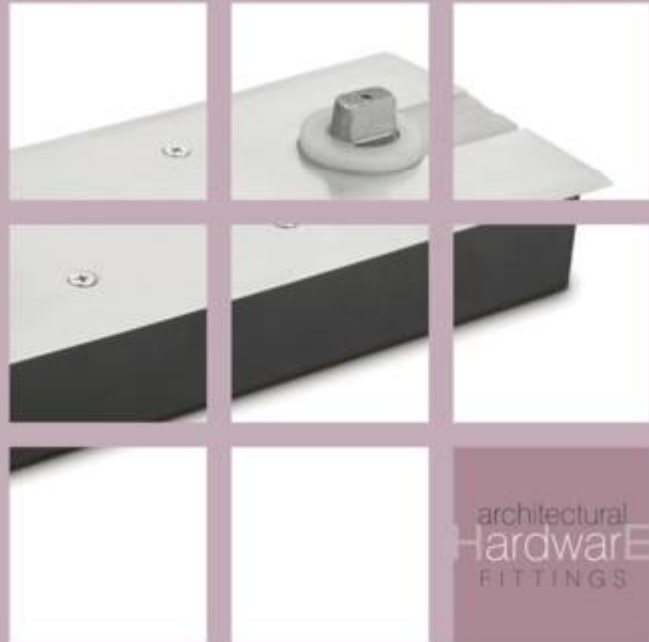

We offer tested door hardware for frame less glass, wooden or metal door and ensure long term smooth movement of the door.

FLOOR SPRING & DOOR CLOSER



AFS-01

Floor Spring, Glass door weight capacity - 80 kg
 Material : Stainless steel 304 grade cover plate & metal body
 Tested : Cycle tested 500,000



TOP PIVOT SET

for Wooden & Aluminium door



WOODEN BOTTOM STRIP

for Wooden & Aluminium door



ADC-01

Door closer (Regular), Door weight capacity - 80 kg
 Material : Aluminium Extrusion Body
 Color : Silver / Golden / Brown / Black
 Tested : Cycle tested 500,000

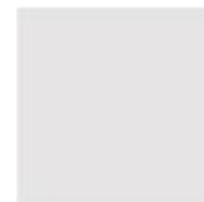

At **alfah**, we constantly endeavor to raise the bar for excellence – be it in our designs, manufacturing or consumer relationship. We are grateful to have you as our valued client, associate and well-wisher and in order to meet your expectations – or even surpass it – we urge you to share your views with us at your convenience, so that we can improve upon perfection. We reiterate our commitment to deliver the most versatile range of architectural hardware fittings that translate your dream into a magical reality.



Mfg. & Mkt'd by

ALFA Industries

Rajkot (Gujarat)

🌐 www.alfahardware.com

✉ info@alfahardware.com