

Easyflex

TM

Flexible Duct Connector



Introduction :

In order to isolate vibrations caused by air handling units, fans or other equipment connected to air ducts, it is highly recommended to install a flexible duct connector joint between the outlet of these devices and the airduct. It is necessary to select an airtight and flexible cloth, with good weathering qualities and one which will withstand the temperatures inside and outside the duct. Duct being generally made of steel, the main difficulty is to fasten the cloth to it in order to obtain a perfectly airtight joint. Easyflex duct connectors are perfect for this job.

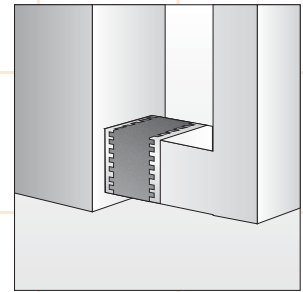
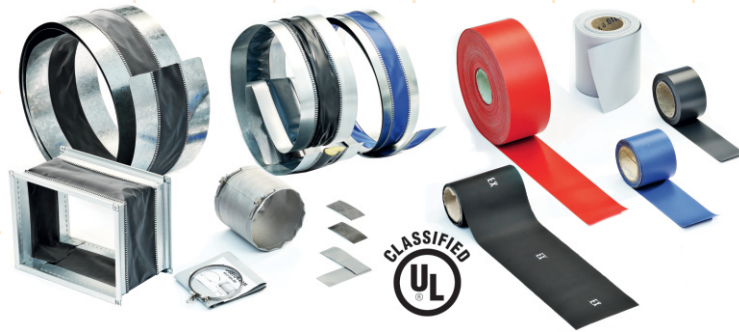

Easyflex offers you a pre-assembled airtight and mechanically resistant flexible duct connector. It consists of a strip of treated cloth, attached on both sides to strips of galvanised steel, using a strong mechanical joint and providing airtightness. In order to meet the requirements of each kind of installation Easyflex has especially developed a wide range of pre-assembled, ready to use duct connectors which offer a quick, easy, economical and efficient method of assembly.

Easyflex flexible duct connector is available in various steel thicknesses, cloth qualities, cloth widths, steel widths and types of seam. Air handling unit manufacturers will, by using narrower widths, be able to produce more compact air handling units, with savings of weight, volume and cost.

Standard Fabrics

Fabric	RO-(Robust)	EO-(Neoprene)	PU-(Polyurethane)	SI-(Silicon)
Backing	Polyester	Glassfiber	Glassfiber	Glassfiber
Coating	PVC	Neoprene	Polyurethane	Silicone
Colour	Dark grey / Black	Black	Aluminium grey	Aluminium grey
Fire Resistance		BS 476 Part 7 Class 1 M1	400°C/2h - M0	BS 476 Part 7 Class 1 M1/M0
Weight Backing	160 gr/sq.m.	520 gr/sq.m.	410 gr/sq.m.	410 gr/sq.m.
Coating	440 gr/sq.m.	2 x 125 gr/sq.m.	2 x 20 gr/sq.m.	2 x 20 gr/sq.m.
Total	600 gr/sq.m.	660 gr/sq.m.	450 gr/sq.m.	450 gr/sq.m.
Temperatures	-30° / +70°C	-20° / +100°C	-50° / +200°C	-50° / +200°C
Use	Very good mechanical resistance Flame Resistant	Very good mechanical resistance. "Hardly Flammable classified	Fragile fabric but "M0 - 400°C/2h classified	Fragile fabric but "M0 - 400°C/2h classified

Flexible duct connector Type LOC 4 - steel 0.4 mm (28 ga.) European Standard

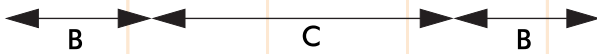
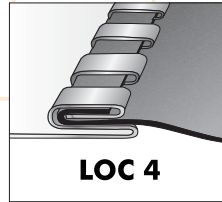
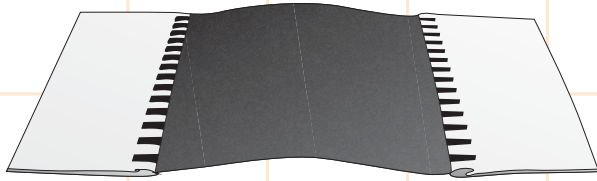

- ⇒ A = thickness of steel: 0.4mm (ga.)
- ⇒ B = steel width
- ⇒ C = fabric width
- ⇒ L = length of roll: 25 m (others on request)

How to order? (example)

RO - 45 - 60 - 25

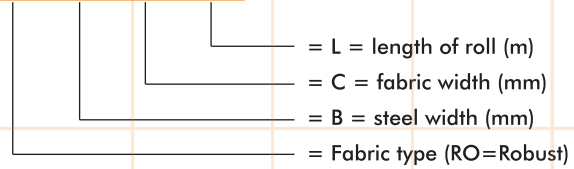

Type	B	C	B	L
Rox	45	60	45	25 mts.
	45	100	45	25 mts.
Neo	45	100	45	25 mts.
	45	125	45	25 mts.
	45	150	45	25 mts.
	100	150	100	15 mts.
Silicon	35	150	35	25 mts.
	45	100	45	25 mts.
	45	150	45	25 mts.
	100	150	100	15 mts.

Recommended assembly method

Ensure that the notched side of the connector faces outward and position the joint in the middle of a side rather than at a corner.

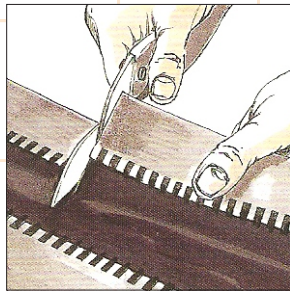

At a notch, cut a length equivalent to the perimeter required plus an overlap of 5 to 6 cm (2") for joining

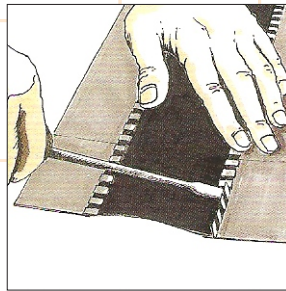

Lift the seam outwards at right angle

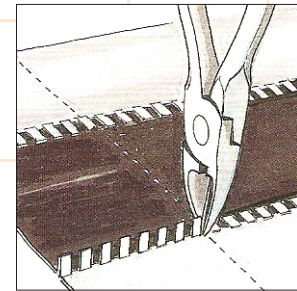

Make a cut at the edge of the lifted seam section

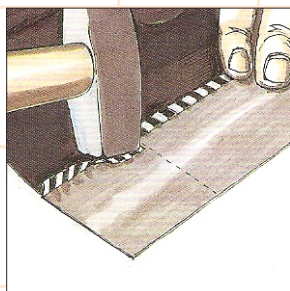

Bend down the seam whilst ensuring that the cloth remains fastened

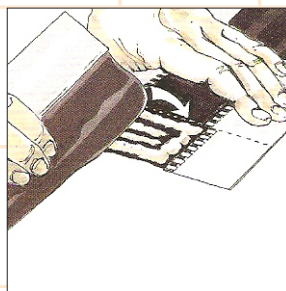

Coat the cloth with the appropriate adhesive. Join both sides and press together firmly

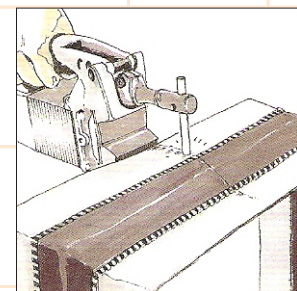

Spotweld the steel and form to the desired shape

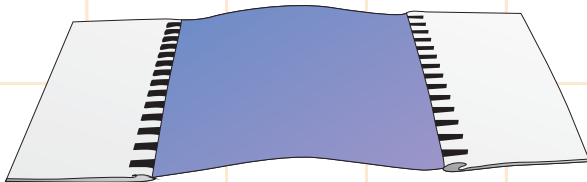
Robust (RO)**Flexible Duct Connector - PVC/Vinyl coated fabric**

- ⇒ Excellent mechanical resistance.
- ⇒ Excellent tear and tensile strength.
- ⇒ Excellent water resistance
- ⇒ All purpose fabric
- ⇒ High temp. : 160° F (+70°C)
- ⇒ Flame Resistant

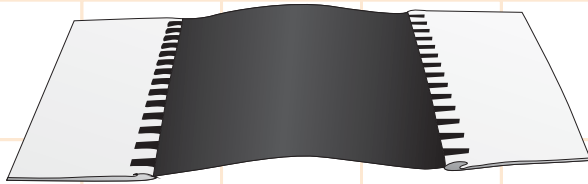
Neoprene (EO)**Flexible Duct Connector - Neoprene coated fabric**

- ⇒ Excellent mechanical resistance
- ⇒ "Hardy Flammable" classified
- ⇒ Very good chemical resistance
- ⇒ High temp. : 210°F (100°C)

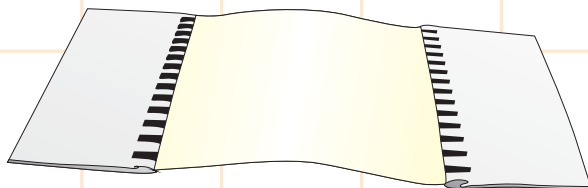
Silicone (SI)**Flexible Duct Connector - Silicone coated fabric**

- ⇒ Excellent high temp. Resistance : 530°F (280°C)
- ⇒ Very good low temp. Resistance : -40°F (-40°C)
- ⇒ Very low smoke emission
- ⇒ Very good chemical resistance
- ⇒ Excellent ozone and weathering resistance

Introduction :

All air duct installations for heating, cooling or ventilation are attached to mechanical equipment containing a fan or blower. This equipment causes vibrations and noises which are transmitted in the metal ducts throughout the installation. In order to isolate vibrations and noises caused by air handling units, fans and other equipment. It is highly recommended to install an airtight flexible joint between the outlet of the devices and the airduct. This joint, consisting of a fabric which is attached to sheet metal on both sides is called a "Flexible Duct Connector". It is necessary to select an airtight and flexible cloth with good weathering qualities and which can temperatures inside and outside the duct. Easyflex flexible duct connectors are perfect for this job.

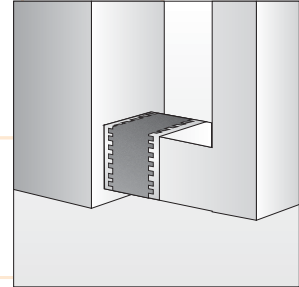

Related NFPA 90A & 90B Standards :

2-3.2.2 Vibration isolation connectors in duct systems shall be made of an approved flame retardant fabric or shall consist of sleeve joints with packing of approved material, each having a flame spread rating of not over 25 and a smoke developed rating of not higher than 50.

Isolex

- ⇒ Made of fiberglass insulation between two layers of fabrics.
- ⇒ "R" value : 4.5
- ⇒ Insulation thickness : 1" (25mm)
- ⇒ Insulation density : 1-1/2 lbs/cft
- ⇒ High temp. : 160°F (70°C)

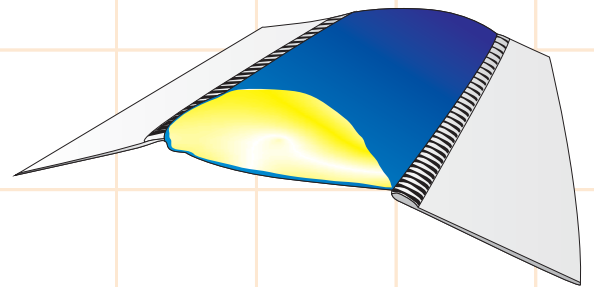

Standard Fabrics

Fabric	Robust RO	EO-(Neoprene)	PU-(Polyurethane)	SI-(Silicon)
Backing	Polyester	Glassfiber	Glassfiber	Glassfiber
Coating	PVC	Neoprene	Polyurethane	Silicone
Colour	Dark grey / Black	Black	Aluminium grey	Aluminium grey
Fire Resistance		BS 476 Part 7 Class 1 M1	400°C/2h - M0	BS 476 Part 7 Class 1 M1/M0
Weight Backing	160 gr/sq.m.	520 gr/sq.m.	410 gr/sq.m.	410 gr/sq.m.
Coating	440 gr/sq.m.	2 x 125 gr/sq.m.	2 x 20 gr/sq.m.	2 x 20 gr/sq.m.
Total	600 gr/sq.m.	660 gr/sq.m.	450 gr/sq.m.	450 gr/sq.m.
Temperatures	-30° / +70°C	-20° / +100°C	-50° / +200°C	-50° / +200°C
Use	Very good mechanical resistance	Very good mechanical resistance. "Hardly Flammable classified	Fragile fabric but "M0 - 400°C/2h classified	Fragile fabric but "M0 - 400°C/2h classified

Introduction :

In order to isolate vibrations caused by air handling units, fans or other equipment connected to air ducts, it is highly recommended to install a flexible connector joint between the outlet of these devices and the airduct. It is necessary to select an airtight and flexible cloth, with good weathering qualities and one which will withstand the temperatures inside and outside the duct. Duct being generally made of steel, the main difficulty is to fasten the cloth to it in order to obtain a perfectly airtight joint.

Easyflex circular straight sleeve connectors are perfect for this job.

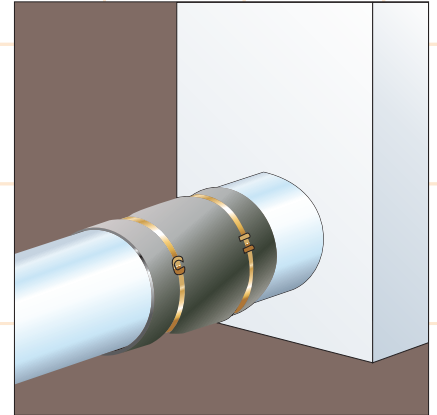

The circular straight sleeves can be produced for any diameter, They are made from Polyurethane cloth strips (M0 and 400°C/2h classified) 160 mm wide and the ends are sewn with a strong, high-temperature thread. Each sleeve is supplied with two suitable clamps. Assembly takes place by sliding the sleeve over the external diameter of the circular duct and its matching part and clamping each end. This is simple and efficient and affords perfect airtightness.

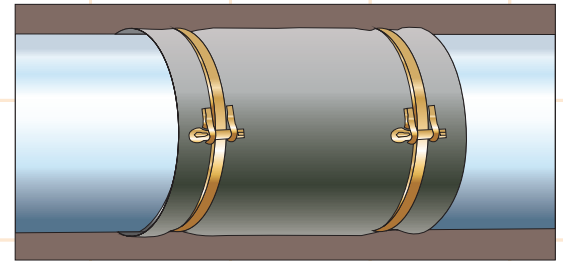

Fabric

- ⇒ Glassfiber coated with polyurethane on both sides
- ⇒ Fire resistance : M0 and 400°C/2h
- ⇒ Sewn with high temperature thread
- ⇒ Other fabrics available on request

Fastening bands

- ⇒ Galvanised steel strip
- ⇒ Thickness : 0,4 mm
- ⇒ Width : 8 mm
- ⇒ Length of the steel bands : (perimeter of the sleeve x2) + 5cm
- ⇒ Security clamp with " Cotter Pin Fastening "

Packaging

- ⇒ Individual bags with one circular straight sewn fabric sleeve finished to required size and two fastening clamps with fasteners
- ⇒ Sold in cartons of 10 individual bags (5 bags for diameters over 900 mm)

The nominal diameter correspond to standard nominal duct diameters.

The actual diameter of the circular straight sleeve is slightly larger to enable the sleeve to be slid on the ducts.



Nominal diameter	Width	Code	Description
125 mm	160 mm	121125	MAN160 - Ø 125
160 mm	160 mm	121160	MAN160 - Ø 160
200 mm	160 mm	121200	MAN160 - Ø 200
250 mm	160 mm	121250	MAN160 - Ø 250
280 mm	160 mm	121280	MAN160 - Ø 280
315 mm	160 mm	121315	MAN160 - Ø 315
355 mm	160 mm	121355	MAN160 - Ø 355
400 mm	160 mm	121400	MAN160 - Ø 400
450 mm	160 mm	121450	MAN160 - Ø 450
500 mm	160 mm	121500	MAN160 - Ø 500
560 mm	160 mm	121560	MAN160 - Ø 560
630 mm	160 mm	121630	MAN160 - Ø 630
710 mm	160 mm	121710	MAN160 - Ø 710
800 mm	160 mm	121800	MAN160 - Ø 800
900 mm	160 mm	121900	MAN160 - Ø 900
1000 mm	160 mm	122000	MAN160 - Ø 1000
1120 mm	160 mm	122120	MAN160 - Ø 1120
1250 mm	160 mm	122250	MAN160 - Ø 1250

Method of application

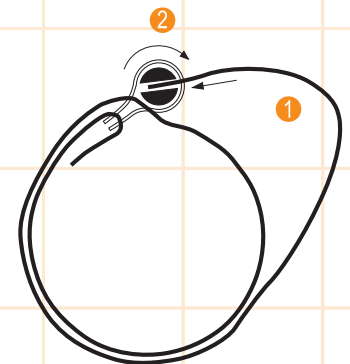

- ⇒ Roll the steelband twice passing underneath the axle and leave 3 to 4 cm slack
- ⇒ Insert the steelband in the axle and turn it clockwise until the slack has disappeared



Other sizes on request.

Other fabrics on request.

Fabric only

Easyflex can also supply its range of fabrics only pre-cut to any desired width.



EasyflexTM

Wrap-on Flexible Duct Connector Style : EFWODC



FLEXIBILITY	: ± 10 MM OR MORE
TEMPERATURE	: UPTO 100° C
PRESSURE RANGE	: -3000mm WC. TO +3000mm WC.
STANDARD WIDTH	: 150 MM / 200 MM
STANDARD LENGTH	: UPTO 5 Meter Rolls

Available in 3 basic types :

- Full Width Fabric.
- With GI / Aluminum Metal edges covered with fabric.
- With GI / Aluminum Metal edges partly covered with fabric.

⇒ Easyflex WRAP-ON Flexible Duct Connector will met every type of installation requirement in hospitals, offices, large buildings, factories, institutions etc.

⇒ Maximum design freedom - does not need to be excessively large than ducting.

⇒ Connectors will effectively isolate Vibration, Noise & Rattles resulting from operation of Fans & blowers.

⇒ Connectors will protect duct work and ancillary equipment from the effect of Vibration, Movements & Misalignment.

⇒ Connectors can be used on both cool and warm side of air conditioning systems - highly suitable for duct carrying heavily moisture laden air.

⇒ Durable construction - Neoprene impregnated and leak proofed fabric is fire retardant, resists grease, gasoline vapours, acids, moisture, mildew, etc.

- Tear resistant.
- Excellent flexing properties.
- Low resistance to deflection.
- Combination of metal & fabric give added strength & flexibility.
- Fire Retardent Neoprene Rubber

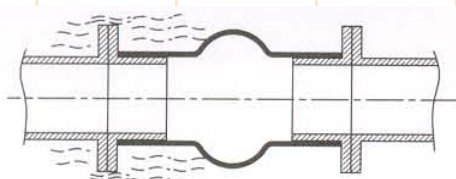

VIBRATION ISOLATION

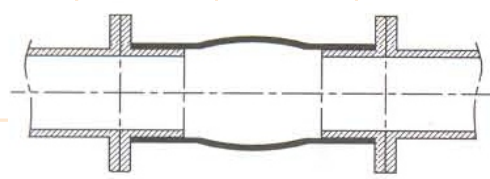

AXIAL EXPANSION

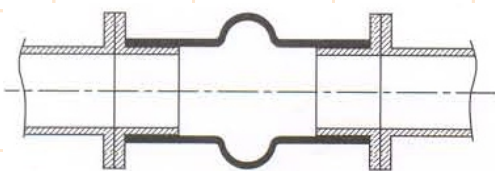

AXIAL CONTRACTION

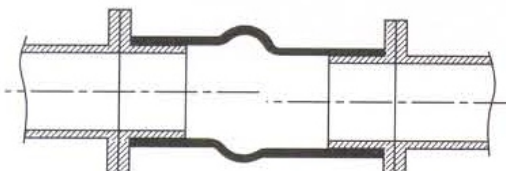

LATERAL DEFLECTION

⇒ Higher Thickness/Length/Polymers available please contact our engineering department.

Features :

- ⇒ To produce a neat, airtight and consistent joint for flexible duct connectors.
- ⇒ Made from Robust or Neoprene fabric combined with a pre-glued tape for simple assembly
- ⇒ Just remove the release paper backing and carefully place the pad over the joint.

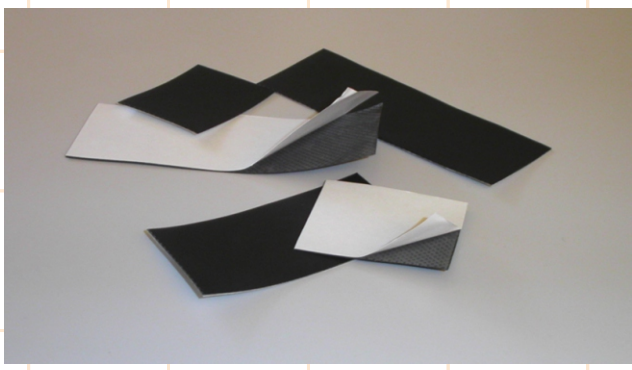

Code	Description	Description	Description W x L	Packaging
191106	RO-ADH-50x60	RO-Robust (PVC-Vinyl)	50x60mm	100 pcs
191110	RO-ADH-50x100		50x100mm	100 pcs
191114	RO-ADH-50x140		50x140mm	100 pcs
198106	ROX-ADH-50x60	ROX-Robust (PVC-Vinyl – light grey)	50x60mm	100 pcs
198110	ROX-ADH-50x100		50x100mm	100 pcs
198140	ROX-ADH-50x140		50x140mm	100 pcs
191206	NEO-ADH -50x60	NEO-Neoprene	50x60mm	100 pcs
191210	NEO-ADH -50x100		50x100mm	100 pcs
191214	NEO-ADH -50x140		50x140mm	100 pcs

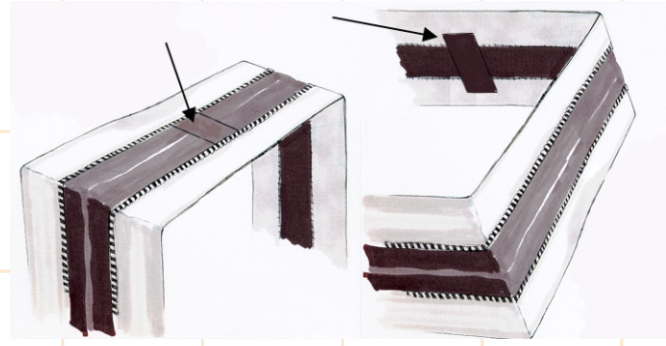
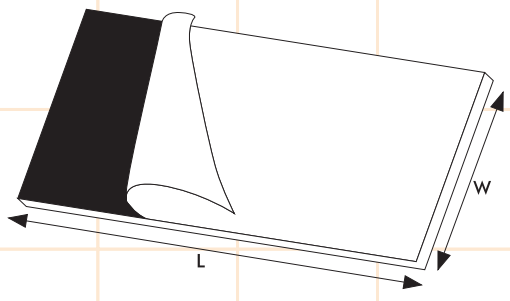

Code	Description	Packaging
191001	DST01-50x50 (Double sided adhesive only)	Rolls 50mmx50m

Introduction :

In order to isolate vibrations caused by air handling units, fans or other equipment connected to air ducts, it is highly recommended to install a flexible connector joint between the outlet of these devices and the air duct. It is necessary to select an airtight and flexible cloth, with good weathering qualities and one which will withstand the temperatures inside and outside the duct. Duct being generally made of steel, the main difficulty is to fasten the cloth to it in order to obtain a perfectly airtight joint. Easyflex Fabric connectors with clamps are perfect for this job.

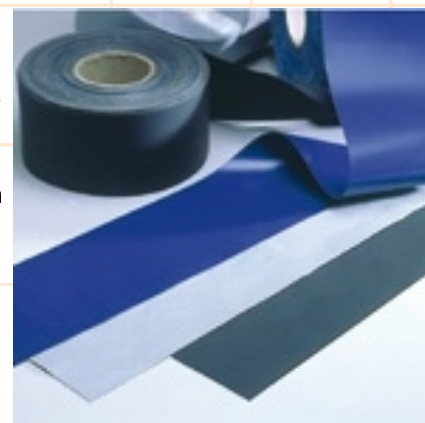

Easyflex offers you rolls of high quality airtight and mechanically resistant fabric strip of treated cloth. The roll ensures that the flexible connector can be cut to different sizes and can be used easily at sites.

Easyflex flexible Fabric connector is available in various cloth qualities, cloth widths as below. Air handling unit manufacturers will, by using narrower widths, be able to produce more compact air handling units, with savings of weight, volume and cost.

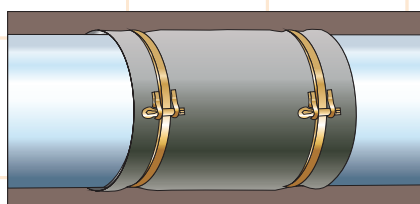

Standard Fabrics

Fabric	RO-(Robust)	EO-(Neoprene)	PU-(Polyurethane)	SI-(Silicon)
Backing	Polyester	Glassfiber	Glassfiber	Glassfiber
Coating	PVC	Neoprene	Polyurethane	Silicone
Colour	Dark grey / Black	Black	Aluminium grey	Aluminium grey
Fire Resistance		BS 476 Part 7 Class 1 M1	400°C/2h - M0	BS 476 Part 7 Class 1 M1/M0
Weight Backing	160 gr/sq.m.	520 gr/sq.m.	410 gr/sq.m.	410 gr/sq.m.
Coating	440 gr/sq.m.	2 x 125 gr/sq.m.	2 x 20 gr/sq.m.	2 x 20 gr/sq.m.
Total	600 gr/sq.m.	660 gr/sq.m.	450 gr/sq.m.	450 gr/sq.m.
Temperatures	-30° / +70°C	-20° / +100°C	-50° / +200°C	-50° / +200°C
Use	Very good mechanical resistance Flame Resistant	Very good mechanical resistance. "Hardly Flammable classified	Fragile fabric but "M0 - 400°C/2h classified	Fragile fabric but "M0 - 400°C/2h classified

⇒ Standard width of 150mm, 200mm, 300mm available.

⇒ Also available in square meter basis on request, please contact our Engineering Department.

Easyflex

TM

Insulated Flexible Duct Connector



Description

Isoflex is highly efficient, resilient, flexible blanket insulation composed of fine, stable and uniformly textured inorganic glass fibers bonded together by a non-water soluble and fire-retardant thermosetting and heat resistant resin. It is free from coarse fibers and shot due to its mineral composition.

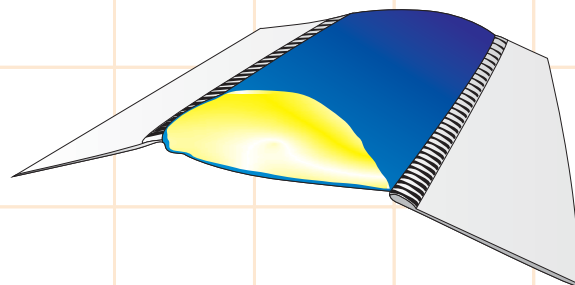

Application

Isoflex is intended for use in commercial, institutional, industrial and residential construction as thermal and acoustical insulation of heating, air conditioning and dual temperature ducts and air handling equipment. The use of Isoflex Wrap helps prevent condensation when properly applied to air-condition ductwork.

The semi-rigid duct wrap with densities from 24 to 40 kg/m³, are flexible insulation rolls for application over irregularly-shaped surfaces where rigid as well as flexible properties are desired.

Features

- ⇒ Non Capillary
- ⇒ Non Hygroscopic
- ⇒ Non Corrosive

Sound Absorption Coefficients

Frequency (Hz)	125	250	500	1000	2000	4000
α_s (60 mm)	0.31	0.59	0.89	1.00	1.05	1.11

Compressive Strength

- ⇒ PSF at 10% deformation: 12
- ⇒ PSF at 25% deformation: 20

Nominal Thermal Conductivity

- ⇒ (ASTM C 518) (BS 874) "K" value at "λ" mean temperature

0°C	10°C	24°C	50°C	75°C	100°C
0,031	0,032	0,035	0,039	0,043	0,047

Fire Properties

- ⇒ Classified A.1 as per EN 13501-1

Working Temperature Limitations (ASTM C 411)

- ⇒ (ASTM C 411) -4°C to + 350° C

Alkalinity

- ⇒ pH 9

Mold Growth (ASTM D 2020, UL 181)

- ⇒ Does not breed or sustain mold, fungus, bacteria or rodents.



Fastening Band & Locking Device



General description

The CBR fastening band allows you to create a custom made fastening band.
 The band is supplied in a dispenser with markings for easy and efficient cuts at the appropriate length.
 The CLD locking device is specially designed to fit our CBR band. Thanks to its tilting screw cage it is easy to adjust at proper perimeter or length.
 Fastening bands are used for quick and easy tightening of flexible ducts.

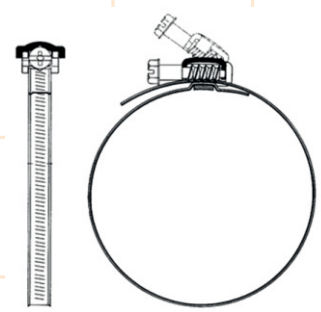
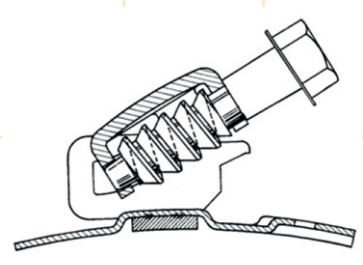
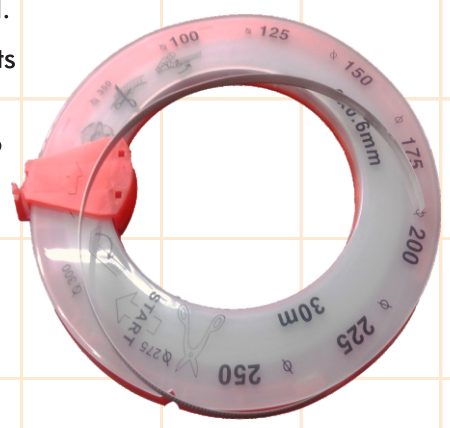

Technical description

BAND CBR	MATERIAL	stainless steel AISI 430 EN
	LENGTH	roll of 30 m
	WIDTH	9 mm
	THICKNESS	0,6 mm

LOCKING DEVICE CLD	MATERIAL	zinc coated steel, passivation free of Cr6+
	SCREW	Hexagonal head Phillips end slotted