

Product Features :

- ⇒ Dimensional accuracy is ensured since each set is individually machine moulded.
- ⇒ Effective means of preventing crushing of insulation at pipe support points of chilled water, condenser water and domestic hot/cold water installation.
- ⇒ Very high load bearing capacity.
- ⇒ Excellent resistance to deterioration or distortion.
- ⇒ Rubber being an inert material, RSI are not corrosive to metal pipes.
- ⇒ Eliminates need for termite control treatment.
- ⇒ Tongue & groove design available.
- ⇒ Various thickness available.
- ⇒ Inherently superior to wood.

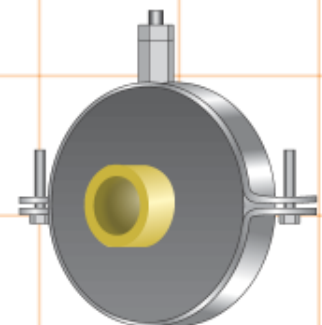
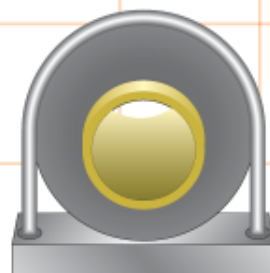
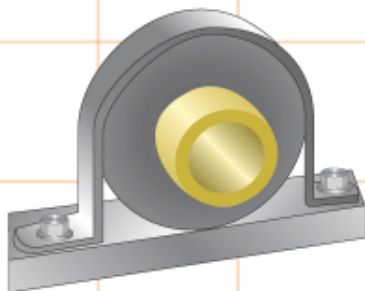
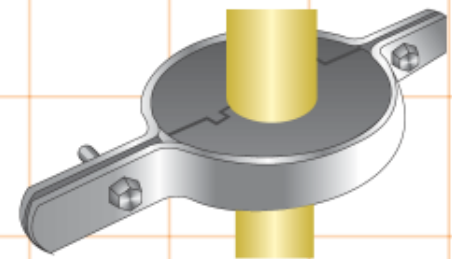
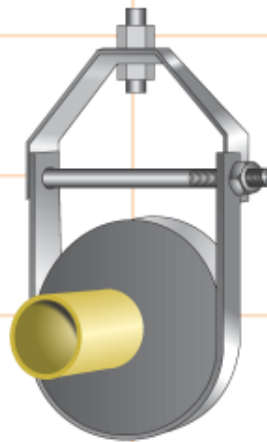
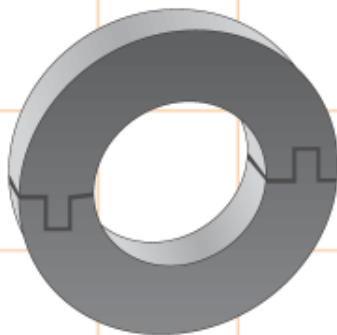
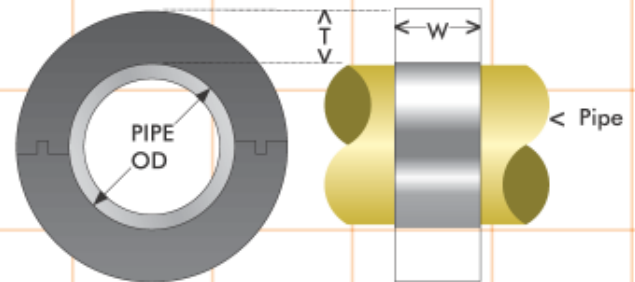

⇒ Due to policy of continual improvement, the specifications are subject to change without prior notice.
 ⇒ Measurements are subject to 5% tolerance.

Product Features :

- ⇒ Dimensional accuracy is ensured since each set is individually machine moulded.
- ⇒ Effective means of preventing crushing of insulation at pipe support points of chilled water, condenser water and domestic hot/cold water installation.
- ⇒ Very high load bearing capacity.
- ⇒ Excellent resistance to deterioration or distortion.
- ⇒ Rubber being an inert material, RSI are not corrosive to metal pipes.
- ⇒ Eliminates need for termite control treatment.
- ⇒ Tongue & groove design available.
- ⇒ Various thickness available.
- ⇒ Inherently superior to wood.

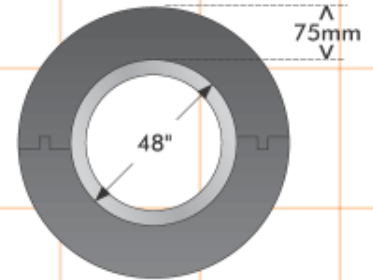

EFRSI ID (inch)	EFRSI Thick (mm)
48	75

Specification :

- ⇒ Material - Compounded Rubber
- ⇒ Density - 1300 kg/m³
- ⇒ Temperature Range - -20°C to 110°C
- ⇒ Thermal Conductivity - 0.16 w/m °C

Standard Width for RSI :

- ⇒ 1/2" to 2" - 25mm
- ⇒ 2 1/2" to 5" - 38mm
- ⇒ 6" & above - 50mm