



Create Strength

Wire Rope Slings Manufacturers 8 mm to 56 mm

- ▶ Polyester Webbing & Round Endless Slings
- ▶ Wire Rope, SS Wire Rope, PVC Coated Wire Rope
- ▶ Wire Rope Clamps, Wire Rope Slings & Chain Slings
- ▶ Eye Hook, Eye Bolt, Turn Buckle
- ▶ D-Shackles & Bow Shackles
- ▶ Plate Lifting Clamps
- ▶ Ratchet Lever Hoist
- ▶ Chain Pulley Block
- ▶ Magnetic Lifter
- ▶ All Material Handling Items & Lifting Tackles



An ISO 9001:2015 Certified Co.



H.O. : VATVA GIDC, AHMEDABAD
UNIT-2 : MAKARPURA GIDC, VADODARA

Polyester Webbing Slings

Colour	Vertical Straight lift	Width	Approx thick(mm)	Chocker	Basket	Basket 45°	Basket 90°	Remarks
VIOLET	1,000 kg	25	7	800 kg	2,000 kg	1,800 kg	1,400 kg	Double Ply
GREEN	2,000 kg	50	7	1,600 kg	4,000 kg	3,600 kg	2,800 kg	Double Ply
YELLOW	3,000 kg	75	7	2,400 kg	6,000 kg	5,400 kg	4,200 kg	Double Ply
GREY	4,000 kg	100	7	3,200 kg	8,000 kg	7,200 kg	5,600 kg	Double Ply
RED	5,000 kg	125	7	4,000 kg	10,000 kg	9,000 kg	7,000 kg	Double Ply
BROWN	6,000 kg	150	7	4,800 kg	12,000 kg	10,800 kg	8,400 kg	Double Ply
BLUE	8,000 kg	200	7	6,400 kg	16,000 kg	14,400 kg	11,200 kg	Double Ply
ORANGE	10,000 kg	250	7	8,000 kg	20,000 kg	18,000 kg	14,000 kg	Double Ply
ORANGE	12,000 kg	300	7	9,600 kg	24,000 kg	21,600 kg	16,800 kg	Double Ply
ORANGE	15,000 kg	250	10.5	12,000 kg	30,000 kg	27,000 kg	21,000 kg	3 Ply
ORANGE	16,000 kg	200	14	12,800 kg	32,000 kg	28,800 kg	22,400 kg	4 Ply
ORANGE	18,000 kg	300	10.5	14,400 kg	36,000 kg	32,400 kg	25,200 kg	3 Ply
ORANGE	20,000 kg	250	14	16,000 kg	40,000 kg	36,000 kg	28,000 kg	4 Ply
ORANGE	24,000 kg	300	14	19,200 kg	48,000 kg	43,200 kg	33,600 kg	4 Ply



Polyester Round Slings

Colour	W.L.L (straight lift) (kg)	Approx thickness (mm)	Approx Width (mm)	Chocker 80%	Basket 200%	Basket 180%	Basket 140%
VIOLET	1,000 kg	6	40	800 kg	2,000 kg	1,800 kg	1,400 kg
GREEN	2,000 kg	7	50	1,600 kg	4,000 kg	3,600 kg	2,800 kg
YELLOW	3,000 kg	8	60	2,400 kg	6,000 kg	5,400 kg	4,200 kg
GREY	4,000 kg	9	70	3,200 kg	8,000 kg	7,200 kg	5,600 kg
RED	5,000 kg	11	75	4,000 kg	10,000 kg	9,000 kg	7,000 kg
BROWN	6,000 kg	12	80	4,800 kg	12,000 kg	10,800 kg	8,400 kg
BLUE	8,000 kg	13	90	6,400 kg	16,000 kg	14,400 kg	11,200 kg
ORANGE	10,000 kg	15	100	8,000 kg	20,000 kg	18,000 kg	14,000 kg
ORANGE	12,000 kg	16	110	9,600 kg	24,000 kg	21,600 kg	16,800 kg
ORANGE	15,000 kg	18	125	12,000 kg	30,000 kg	27,000 kg	21,000 kg
ORANGE	20,000 kg	20	150	16,000 kg	40,000 kg	36,000 kg	28,000 kg
ORANGE	30,000 kg	32	200	24,000 kg	60,000 kg	54,000 kg	42,000 kg
ORANGE	50,000 kg	45	220	40,000 kg	1,00,000 kg	90,000 kg	70,000 kg
ORANGE	80,000 kg	70	260	64,000 kg	1,60,000 kg	144,000 kg	112,000 kg
ORANGE	1,00,000 kg	80	290	80,000 kg	2,00,000 kg	180,000 kg	140,000 kg



How to Order

- Webbing Slings With Eye Loops
 - Vertical Capacity in Ton & Effective Length (Loop to Loop In Mtrs)
- Round Endless Slings
 - Vertical Capacity in Ton & Circumferential Length or Effective Length (Half of Circumferential Length)

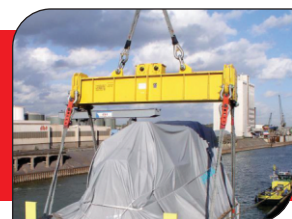

Cargo Lashings

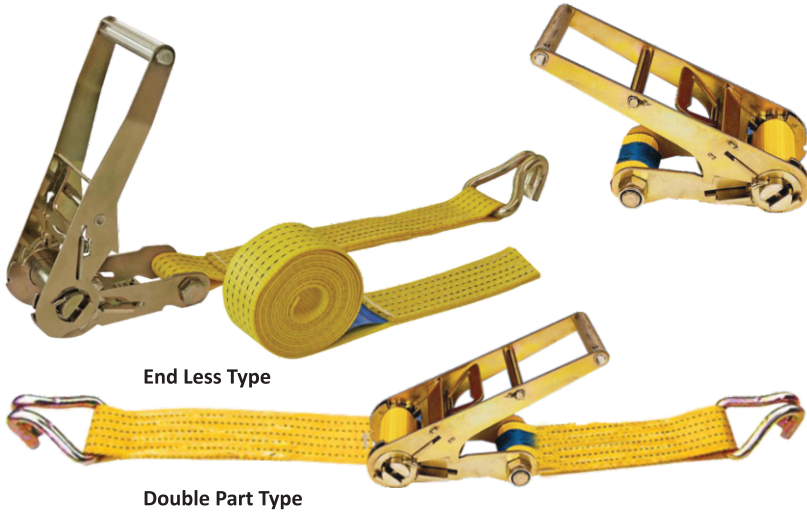

Multileg Slings



Special Purpose Slings (Zola Type)

We are also Manufacturing Special type of Slings for Special Applications Where Diameter of Round Shaped Objects are Very Large in Size, Range up to 1200mm Wide Flat Belts are Available with us.



Parallel Lane Slings Can Be Used As a Eye & Eye



Slings

Anti - Cutting Sleeve



Polyester Double Sided Polyurethane Anti Cutting Sleeve

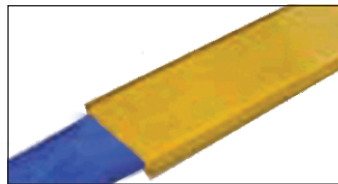

Anti - Abrasive Sleeve



Heavy Duty Synthetic Anti Abrasive Sleeve Enhances Life of The Sling as A Guard Against Abrasion by Rough Surface.

SS ROPE, CHAIN AND FITTINGS

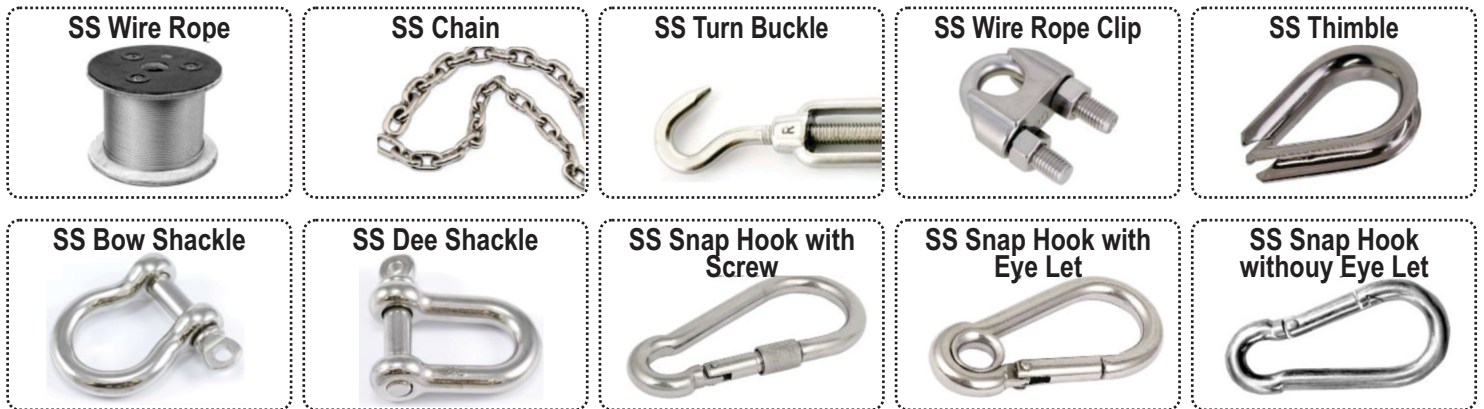

Type of Chain Slings

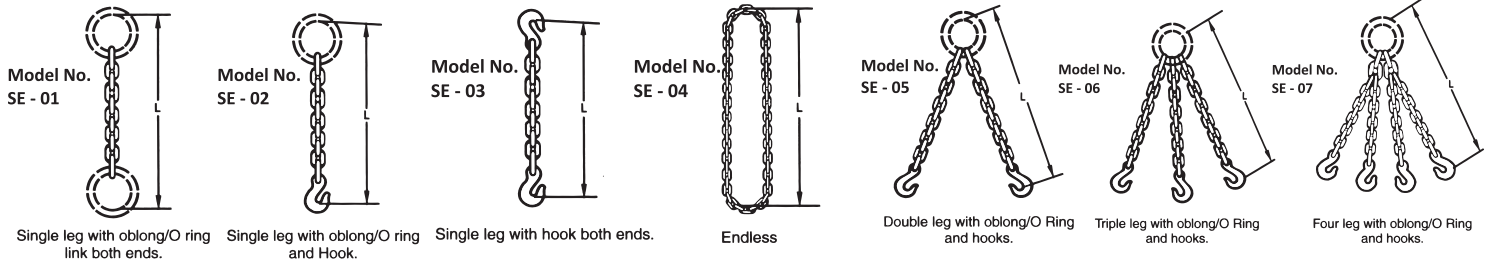

Type of Single Part Slings

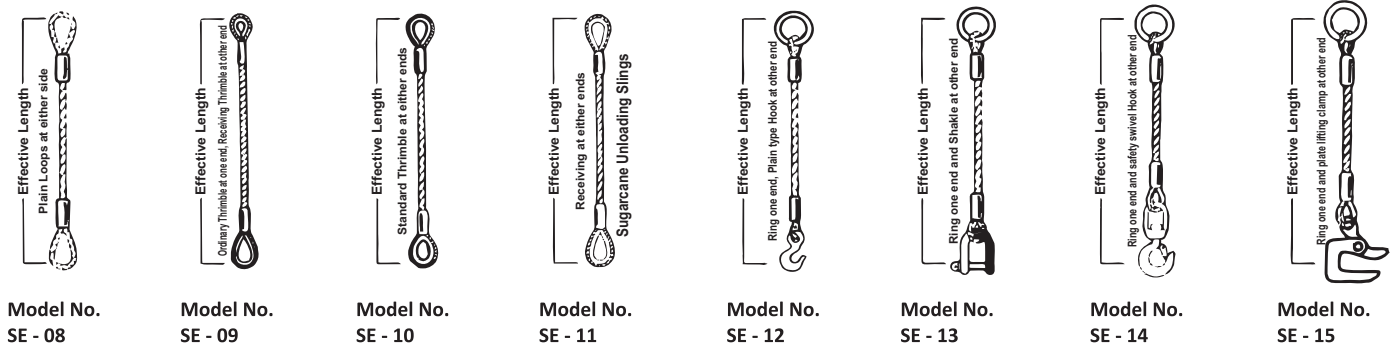

Multiple Leg Wire Rope Slings

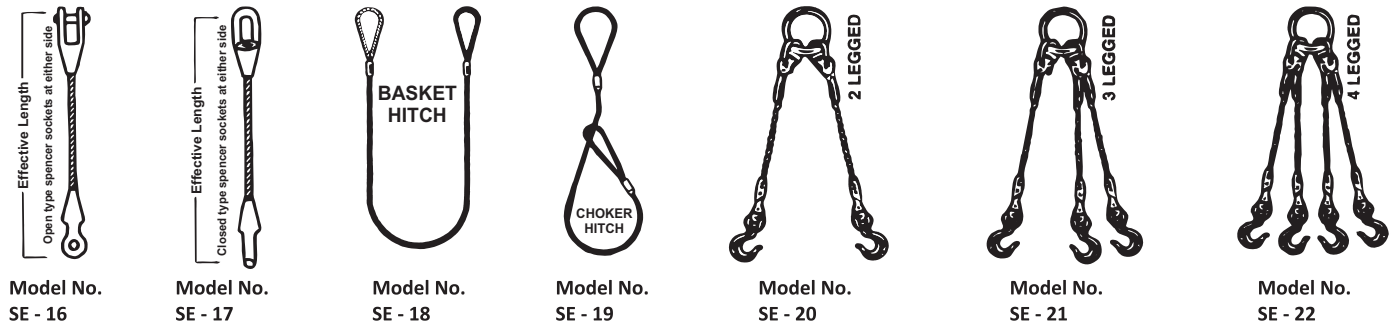

Chain Attachments

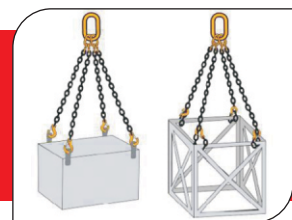
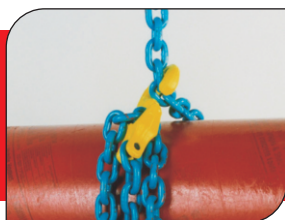

Wire Rope Pulley Blocks

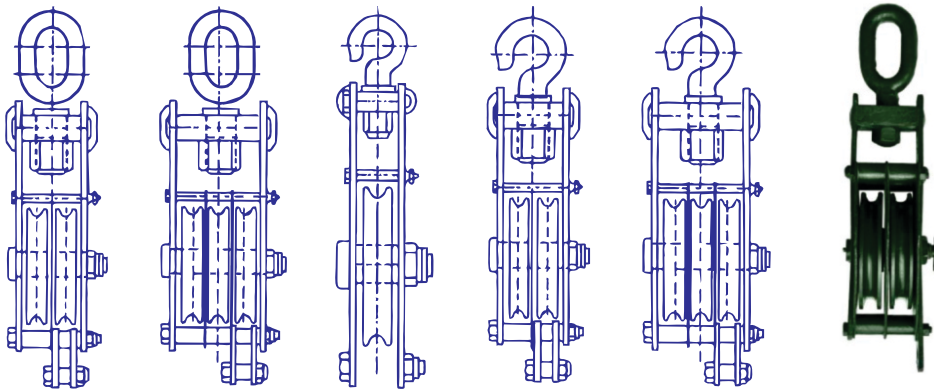

ROPE DIA	SINGLE SWL	DOUBLE SWL	TRIPLE SWL
3/8"	1000	2000	3000
1/2"	1500	3000	5000
5/8"	2500	5000	7000
3/4"	3000	6000	9000
1"	5000	10000	15000
1 1/8"	7500	15000	20000
1 1/4"	10000	20000	30000

Manila Rope Pulley Blocks



ROPE DIA	SINGLE SWL	DOUBLE SWL	TRIPLE SWL
1/2"	100	150	250
5/8"	150	200	300
3/4"	200	400	500
3/4"	500	1000	1500
1 1/4"	600	1500	2000
1 1/2"	1000	2000	2500

Turn Buckles



Bottle Screw

SIZE	BODY	SWL
M-10	160 MM	300 KGS
M-12	200 MM	450 KGS
M-16	250 MM	700 KGS
M-20	3150 MM	1150 KGS
M-22	355 MM	1650 KGS
M-24	400 MM	2000 KGS
M-30	450 MM	3200 KGS
M-36	450 MM	4500 KGS
M-39	450 MM	5000 KGS
M-52	450 MM	10000 KGS
M-56	450 MM	15000 KGS
M-62	450 MM	20000 KGS



Dee Shackles

Bow Shackles

Model No.
SE - 32



Model No.
SE - 33

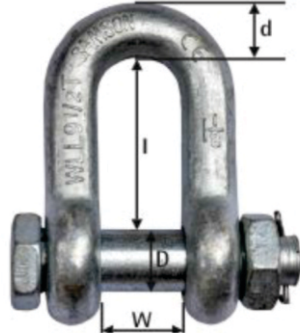

Model No.
SE - 34



Model No.
SE - 35

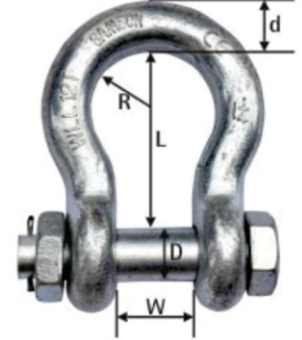

Galvanised Eye Bolt



Galvanised Eye Nut



MS Black Eye Bolt



Swivel Eye



Swivel Hoist Ring (Standard)



Rotating Eye Bolt



Thimble



Solid Thimble



Bulldog Grip/ Forged Clamp (Indian)



Bulldog Grip/ Forged Clamp (CRB TYPE)



PVC Coated Wire Rope



Available Size : 2X4, 3X5, 4X6, 6X8, 8X10, 10X12

Safety Sling (Whip Check)



Cable Clamping Dia
7 to 14 mm



Cable Clamping Dia
25 mm



Cable Clamping Dia
Multi Cable



Wire Rope Metal Trolley
Multi Calbe

Horizontal Plate Lifting Clamp Indian



Horizontal Plate Lifting Clamp Imported



Vertical Plate Lifting Clamp Indian



Universal Plate Lifting Clamp Imported



Pipe Lifting Clamp



RUBBER COATED

Beam Clamp



Gear Trolley



Cap : 1, 2, 3, 5, 10 Ton

Magnetic Lifter



Ratchet Lever Hoist



Cap : 0.75, 1.5, 3, 6 Ton

Pulling Lifting Machine



Motorised Winch



Electric Hoist



Motorized Trolley

Cap : 0.5, 1, 2, 3, 5 Ton



Crane Weigher



Cap : 1, 2, 3, 5, 7, 10, 15, 20, 25, 30, 40 Ton

Bottom Hook Assembly



Hydraulic Hand Pallet Truck



Chain Pulley Block

Cap : 1 Ton to 10 Ton up to 15 mtr Height



Chain Hoist

Cap : 0.5, 1, 2, 3, 5, 7.5 & 10 Ton



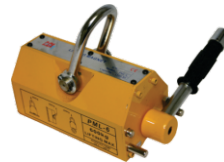

An ISO 9001:2015 Certified Co.



Marketing Manager : Hiren Modi - M. : 99044 07099

Office : 21 Shreenathji Industrial Estate, Nr. PNB Bank, Bombay Conductor Road, Phase-I, GIDC VATVA, Ahmedabad - 382445. (Guj.) M. : 99242 00551. Off. M. : 99044 07051, E-mail : shubhament31@yahoo.com

Unit-2 : GF-34, Vardhini Industrial Estate, Plot No. 203, Nr. Hanumanji Temple, Makarpura GIDC, Vadodara-390010. M. 9904402407, 9904407055 Web. : shubhamententerprise.co/