



TNY Series-Multifunction Panel Meter



Installation Guide

Rev.-01

INDEX

1. Introduction :
2. Features :
3. Model Selection :
4. Specification
5. Integer Flow :
6. Auxiliary Supply :
7. PT Supply :
8. CT Connection :
9. Wiring Diagrams :
10. Key Functions :
11. Meter Measurement Scrolling :
12. KVA Measurement Method :
13. Trip function :
14. Setting/Configuration Modes :
- 15 . Programming mode Details :
16. Dimensional details_



1. Introduction :

TNY series meters are compact digital power meter, equipped with customized 4 digit, 3 row alphanumeric display. Three navigator keys & alphanumeric digits simplifies Display & configuration of meter. TNY series are available with accuracy class of 1.0 IEC 62053-21/(Optional 0.5,0.2 IEC- 62053-22) Modbus Communication On RS 485 or RS232.

2. Features

- Simultaneous Display of Measured Quantity & Parameter
- Trip Function enables user to have record of integration qty. from a selected time
- Auto scaling of Kilo Giga, Mega and decimal Point
- Password protection for user programmable parameters
- Modbus Communication on RS - 485 or RS232
- Meter / Wiring configuration is field programmable as Star/ Delta/ Single Phase connection.
- Accuracy Class 1.0 IEC 62053 - 21/ (Optional 0.5;0.2 IEC 62053-22)
- Selectable auto & manual scroll of display
- 18 LEDs (9 in each column) near display
- Poly carbonate body
- IP 65 from front

MEASUREMENT	PARAMETERS	TNY-2411	TNY-2443		
Basic					
Voltage	VLL, VLN	■	■		
Line Current	IR, IY, IB	■	■		
Frequency	Hz	■	■		
Average	I		■		
Neutral current	Calculated		■		
Power					
Apparent Power	VA , VA1, VA2, VA3		■		
Active Power	W, W1, W2, W3	■	■		
Power factor	PF, PF1, PF2, PF3	■	■		
Integration Present					
Active Energy	Wh	■	■		
Apparent Energy	Vah		■		
Run Hour	RnHr	■	■		
Load Hour	Ldhr		■		
Interrupts	Nos.		■		
Old					
Active Energy	Wh	■	■		
Apparent Energy	Vah		■		
Run Hour	RnHr	■	■		
Load Hour	Ldhr		■		
Interrupts	Nos.		■		
Trip					
Active Energy	Wh	■	■		
Apparent Energy	Vah		■		
Run Hour	RnHr	■	■		
Load Hour	Ldhr		■		
Interrupts	Nos.		■		
THD					
THD	V&I		■		

4. Specification

Accuracy	: Class 1.0 IEC 62053 - 21/ (Optional 0.5;0.2 IEC 62053-22)
Input Voltage	: Vr, Vy, Vb, Vn
Input Voltage Range	: 18-520V (L-L) / 10V-300V (L-N)
Isolation Voltage	: 2000V
Input Current	: Ir, Iy, Ib
Input Current	: 50mA-6A (Accuracy range)
Starting Current	: 1-200mA (programmable)
CT Burden	: 0.2VA max. per phase
Current with stand	: 10A continuous, 50A for 1 Second
Input Frequency	: 40 to 70Hz
Auxiliary Supply	: 35-300V AC/DC
Auxiliary supply burden	: <4VA
Display	: 3 Row 4 Digit (LCD)
Display Scrolling	: Automatic/Manual
Pulse Output Contact Rating	: 50mA (Optional, Max. Pulse width 250+50ms 24VDC)
Communication	: Modbus Comm. on RS-485 or RS-232
CT Primary setting	: 1A to 999kA
CT Secondary setting	: 1A to 10A
PT Primary setting	: 50V to 999kV
PT Secondary setting	: 50V to 999 V

5. Integer Flow

V.PRI x A.PRI x 1.732	Max Reading (Wh/VAh)	Max time to reset the integrator in Run Hours	Max time to overflow in months at full scale
1VA to 40KVA	999999.999KW	100 years	2.8 years
40KVA to 40MVA	999999.999MW	100 years	2.8 years
>40MVA	999999.999GW	100 years	Depends upon setting

6. Auxiliary Supply :

SMPS Supply with input range 35-300V AC/DC. Burden on auxiliary supply is less than 4VA.

7. PT Supply :

TNY can withstand maximum voltage of upto 1000V. Meter can be configured for 3P-4Wire, 3P-3Wire/1Phase connection. Maximum Burden on PT is Less than 0.1VA

8. CT Connection :

Nominal Current of TNY Meter is 6 Amp. Maximum Continuous Current is 10Amp & Current with stand is 50A for 1 Second. Burden on ct less than 0.2VA

9. Wiring Diagrams :

9.1 3-Phase 4-wire connection

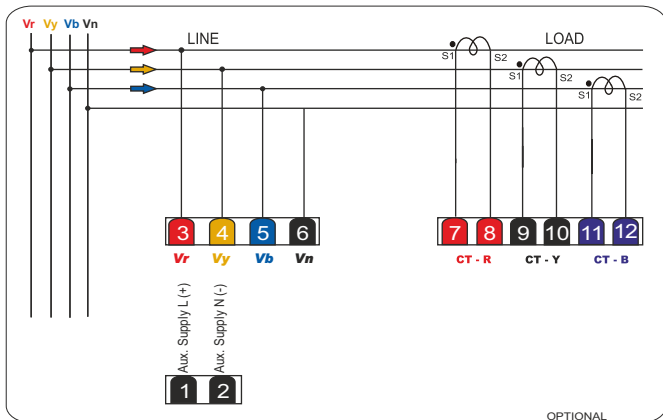

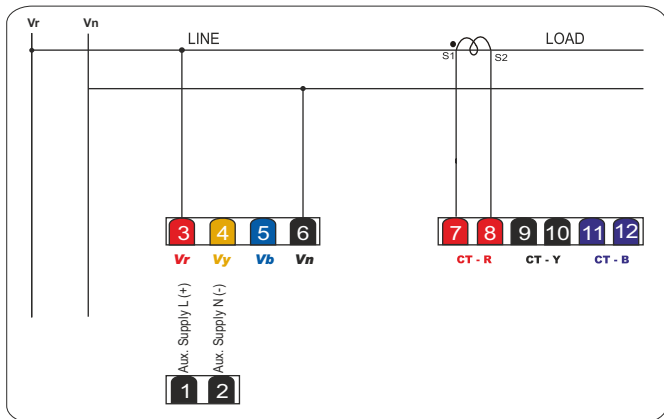

9.2 Single phase connection

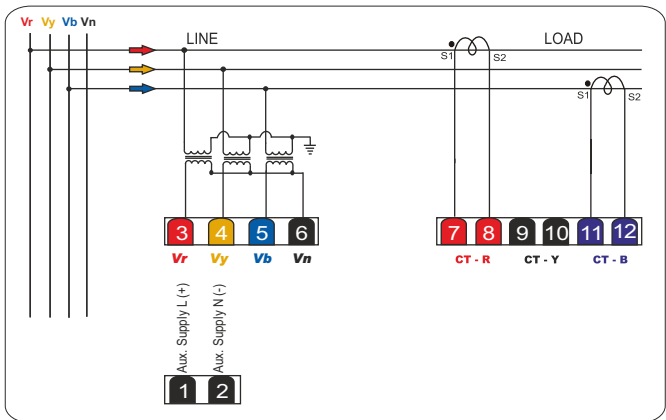

9.3 3-phase 3-wire delta connection



10. Key Functions :

KEY	In EDIT Mode	In Measurement Mode
 Increment	Increment the value of selected parameters.	Long push (for 3sec approx for Scroll ON/OFF
 Decrement	Decrement the value of selected parameters.	-----
 Next	Scrolling to the next parameter in EDIT mode	Scrolling between different measurements parameters.

11. Meter Measurement Scrolling :

Display can be set as auto scroll/Manual scroll Scrolling mode can be changes from auto to manual & vice versa by long press (for 3 sec) of increment key.

In auto scroll the measurement display changes to next page automatically while in manual mode (scroll) measurement page can be selected by pressing Next key.

12. KVA Measurement Method :

3d Recommended method of measurement in case of distorted/unbalance load condition.

Arthematic Conventional method of measurement.

13. Trip function :

Trip function enables the user to have reading of selected cumulative measurement between any two selected time. Please refer 14.5 for resetting the trip reading.

14 . Setting/Configuration Modes :

14.1 EDIT Mode :

This mode is password protected. Set values can be changed in this mode (Editable setting are indicated in table 15.1 along-with setting range)

Example-To change the voltage primary from **415** to **1.2 kV** follow the following steps :-

- a) Press **decrement** and **Next** key together
- b) **EDIT** appears on display.
- c) Press **Next** key.
- d) Display will show **PASS 000** , press **increment** key to reach **123** which is the default password.
- e) Once **123** is set, press **forward** key, display will show **PASS OK**.
- f) Press **Next** key.
- g) Display will show **PTPR VAL 415**, use **decrement** key to reach **120** and press **Next** key
- h) Display will show **PTPR dEC 120**, use **increment/decrement** key to put decimal at **1.20**. Press **Next** key.
- i) Display will show **PTPR UNIT 1.20**, use **increment/decrement** key to change unit to **KILO**, display will show **PTPR UNIT 1.20** with a **K** subscript meaning the value is **1.2 kV**.

Table : 15.1

Display	Description	Range
PTPR VAL	PT Primary Value	50-999
PTPR dEC	PT Primary Decimal Place	-
PTPR UNIT	PT Primary Voltage Unit	Decimal, Kilo
PTSR VAL	PT Secondary Value	50-999
CTPR VAL	CT Primary Value	1-999
CTPR dEC	CT Primary Decimal place	-
CTPR UNIT	CT Primary Unit	Decimal, Kilo
CTSR VAL	CT Secondary Value	1-10
KVA TYPE	KVA Measurement Mode	3d/ARTH
SYS CONF	System Configuration	3P4W/3P3W/1P
STRT MA	Starting Current	1mA-200mA
dEV Id	Device Identification for communication	1-247
bAUd Rate	Communication baud rate	1200, 2400, 4800, 9600, 19200
Comm PARI	Communication parity bit	Even, odd None
Stop bit	Stop Bit for Communication	1-2

14.2 View Mode :

It is possible to view all the set values even without entering the password. Change of values is not permitted in this mode.

14.3 Old Mode :

User can view old data/value of all available integration parameters (eg. Wh, RnHr, LdHr, interrupts)

14.4 Trip Mode :

This enables user to view log of integration parameter since the last reset. User can reset trip data at any moment. Resetting of trip values, restarts integration process, which keeps on going till it is reset again.

14.5 RST Trip :

Reset of trip data is password protected. Entering correct password in this mode, resets trip values of integration parameter.

14.6 RST Pass :

New password can be programmed in this mode. Once the password is changed, it is not possible to retrieve the old password, hence it is recommended to have a record of new password.

15. Programming Mode Details :

15.1 EDIT Mode :

Parameter values can be changed in 'EDIT' mode, 'EDIT' mode is password protected.



Press **Decrement** and **Next** key together



EDIT appears on display.



Press Next key.

Display will show **PASS 000**



Press **increment** key to reach **123** which is the default password.

Once **123** is set



Press **Next** key,

Display will show **PASS OK**.



Press **Next** key.

First editable parameter which is PT primary value appears on display.

15.4 TRIP Setting Mode :

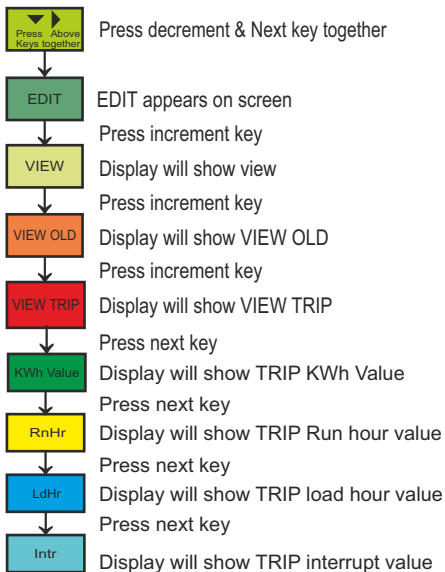

15.5 RST Trip Setting :

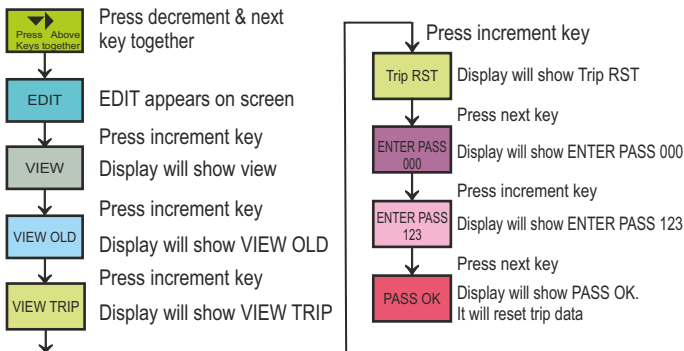

15.2)

View Mode:

User can view all set values in this mode without entering password :



Press **decrement** and **next** key together



EDIT appears on display
Press **increment** key.



Display will show **View**
Press next key to enter into **view** mode.



First editable parameter which is PT primary Value appears on display. User can view next parameter value by pressing increment key

15.3 OLD Setting Mode :



Press **decrement** and **next** key together



EDIT appears on display
Press **increment** key.



Display will show **View**
Press **increment** key and the



Display will show **VIEW OLD**
Press **next** key to enter the **OLD** mode.



Display will show old KWh Value



Press next key
Display will show old Run hour value Press next key



Display will show old load hour value
Press next key



Display will show old interrupt value

15.7 Communication Setting Optional :

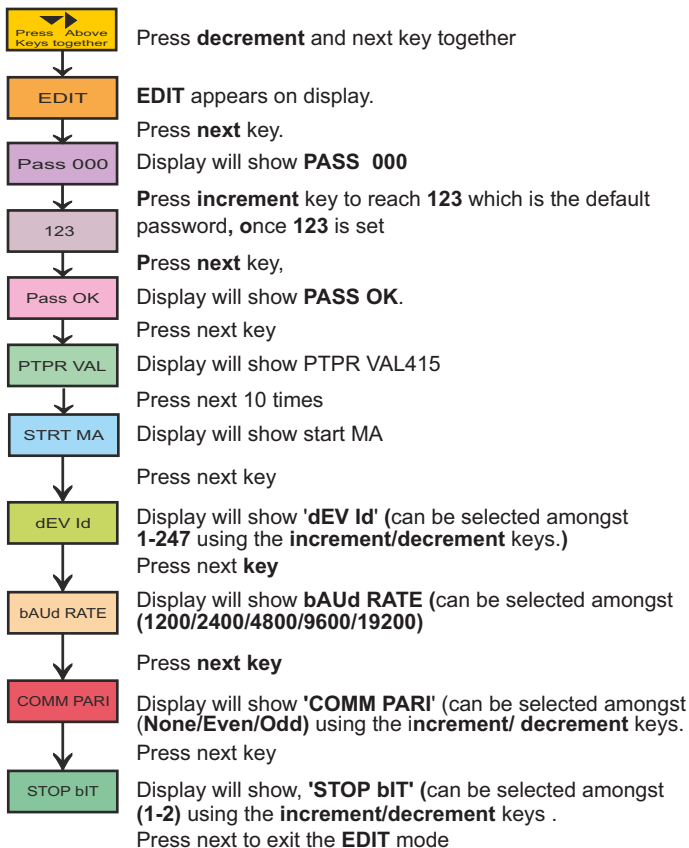

15.6 RST Password :

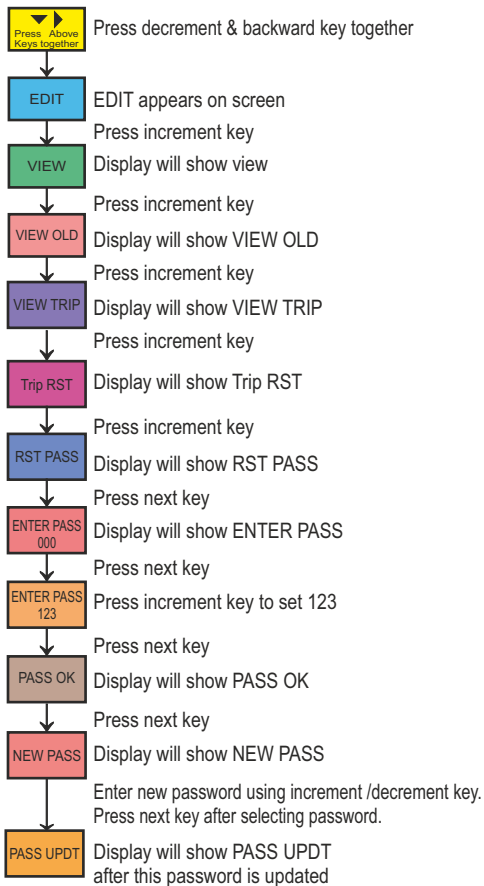

16. Dimensional details_

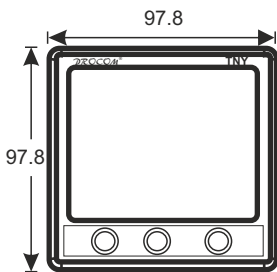

Front View

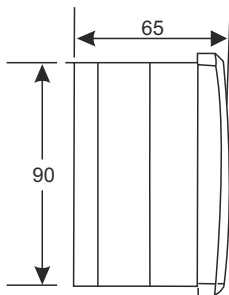

Left View

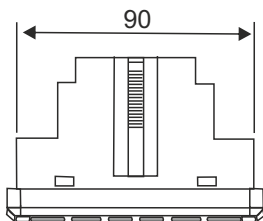

Top View

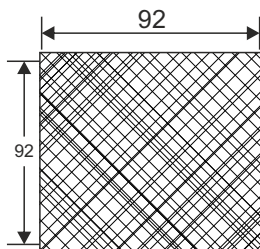

Panel Cutout

All dimensions are in mm.

16. Dimensional details_

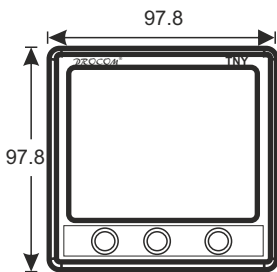

Front View

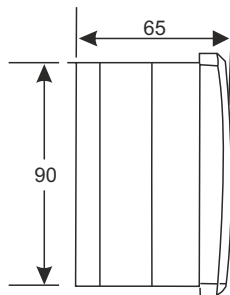

Left View

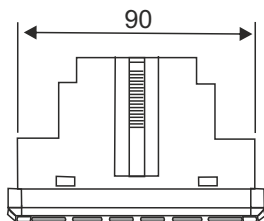

Top View

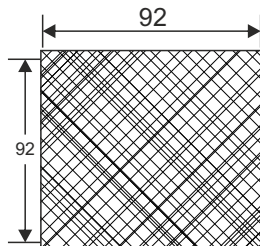

Panel Cutout

All dimensions are in mm.

MRM **PROCOM**[®] Pvt. Ltd.
Plot No. 20-21, Industrial Estate
Sector-59 (II), HUDA, Faridabad-121004, Haryana
Phone: 0129-4700400 (10 Lines), E-mail : info@mrmprocom.com
Website : www.mrmprocom.com