

SoClean®

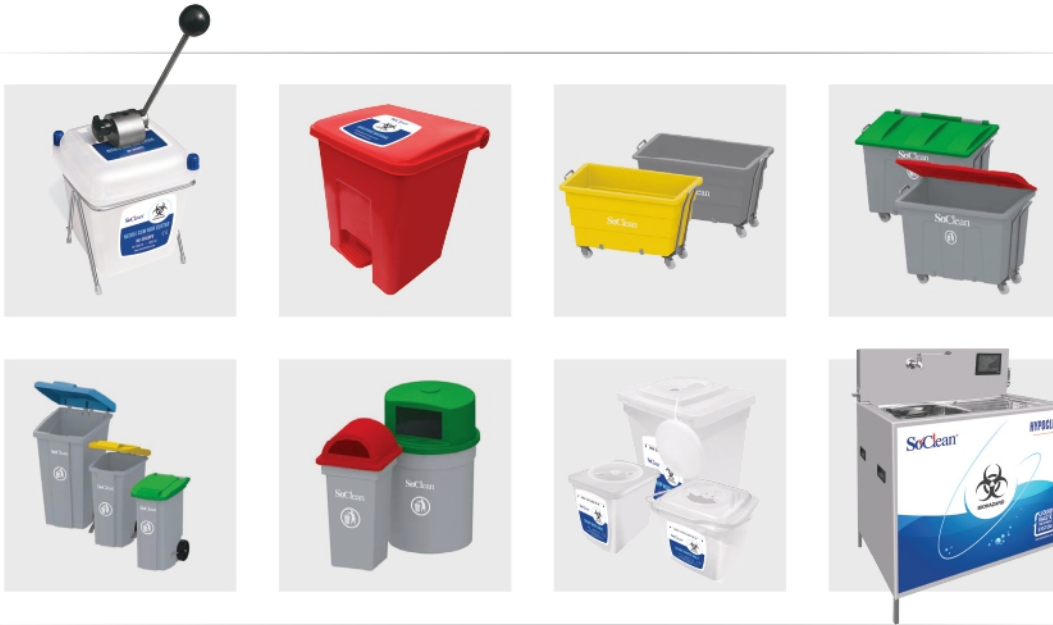

SOLUTIONS FOR BIO-MEDICAL WASTE

MANAGEMENT / SEGREGATION / DISPOSAL



PRODUCT
CATALOGUE
2022 / 6

COMPANY PROFILE

SoClean® Hail Mediproducts Private Limited

Hail Mediproducts Private Limited has been established in 1997, by a team of professionals. Team has experience of more than 19 years as manufacturers, importers & distributors of medical equipments & Devices. Committed to provide International quality Equipments at reasonable prices, complimented by our efficient & versatile customer support system. Having vast experience & proven track record in Government Supplies. We specialize in Equipments, Instruments, Devices & Disposables used in Bio Medical Waste Management as well as Infection Control.



Global Excellence Awards 2018 Winner
Awarded as Best Waste Management Equipment Manufacturer



Receiving Make in India Award from MSME Minister



ISO 9001:2015



ISO 13485:2013



CE

NEEDLE CUM HUB CUTTER

No-Sharps 1000 ml (NS-1000)

Destroys Syringe Hub & Needle in Single Action

FEATURES

- Destroys Syringe Hub & Needle in Single Action
- Reusable and autoclavable container
- Stops Reuse of Needles and Syringes
- Saves Healthcare Professional from Needle Stick Injuries.
- No Electricity Required.
- No Burning, No Fumes
- No Noise, No Smell
- Capacity 1000 ml

UV
STABLE

POLYMER

NON
FADING
COLOURS

ISO
13485:2013
Certified

MINIMUM
50,000
CUTS LIFE



NEEDLE CUM HUB CUTTER DELUXE

No-Sharps 1000 ml (NS-1000 Dx)

Destroys Syringe Hub & Needle in Single Action

- Destroys Syringe Hub & Needle in Single Action
- Reusable and autoclavable container
- Stainless Steel Stand for stability
- Stops Reuse of Needles and Syringes
- Saves Healthcare Professional from Needle Stick Injuries.
- No Electricity Required.
- No Burning, No Fumes
- No Noise, No Smell
- Capacity 1000 ml
- Wall mounting possible

MINIMUM
1,00,000
CUTS LIFE



NEEDLE CUM HUB CUTTER DELUXE

- No-Sharps 800 ml (NS-800 Dx)
- No-Sharps 1500 ml (NS-1500 Dx)
- No-Sharps 3500 ml (NS-3500 Dx)
- No-Sharps 5000 ml (NS-5000 Dx)

Destroys Syringe Hub & Needle in Single Action

UV
STABLE



NON
FADING
COLOURS

ISO
13485:2013
Certified

MINIMUM
1,00,000
CUTS LIFE



FEATURES

- Meets Biomedical Waste Disposal Norms
- Destroys Syringe Hub & Needle in Single Action
- Disposable puncture-proof sharps container
- Strong and Stable Stainless Steel Frame
- Easy to change sharps container
- Stops Reuse of Needles and Syringes
- Saves Healthcare Professional from Needle Stick Injuries
- No Electricity Required.
- No Burning, No Fumes
- No Noise, No Smell
- Capacity 800 ml, 1500 ml, 3500 ml & 5000 ml
- Wall mounting possible



NS-5000 DX



NS-3500 DX



NS-1500 DX



NS-800 DX

NEEDLE & HUB CUTTER

No-Sharps Basic (NS-B)

Manual Needle Destroyer to cut Needle
and Syringe Hub Separately



FEATURES

- Body made of Stainless Steel / ABS
- Upper Lid made of Virgin Plastic
- Syringe Hub & Needle gets cut off by a sharp blade by pulling the handle.
- Separate holes for inserting Needles & Syringe hub.
- No electricity required
- Economical & Reusable

ABS Body

NEEDLE & SYRINGE HUB CUTTER - ELECTRIC

No-Sharps Electric (NS-E)

Destroys Needle by electric incineration
and cut the Hub of Syringe to render it unusable

FEATURES

- Incinerates the needle electrically
- Heavy duty copper coil for longer life
- Manually operatable in absence of electricity
- Cuts the syringe hub
- Collection container to collect the waste
- Shock-proof ABS body
- Portable, compact and handy



SHARPS CONTAINERS

SC-0.8 / SC-1.5 / SC-3.5 / SC-5
SC-6.5 / SC-10 / SC-26

UV
STABLE

POLYMER

NON
FADING
COLOURS

ISO
13485:2013
Certified



FEATURES

- Meets Biomedical Waste Disposal Norms
- Solid and stable shape
- Translucent and Puncture resistant
- Ergonomic handle
- Indents for needles removal.
- Pole / Trolley / Wall mounting possible.
- Permanent closing facility
- Maximum filling level indicator
- Temporary closure easy to activate, with visibility of the inside
- No emission of any harmful gasses during the incineration process
- Available in 0.8 Ltr., 1.5 Ltr., 3.5 Ltrs., 5 Ltrs., 6.5 Ltrs., 10 Ltrs. 12 Ltrs. & 26 Ltrs. capacity



Wide opening & indents
for needle's removal

Temporary closure

Permanent closure



Available Colour variants

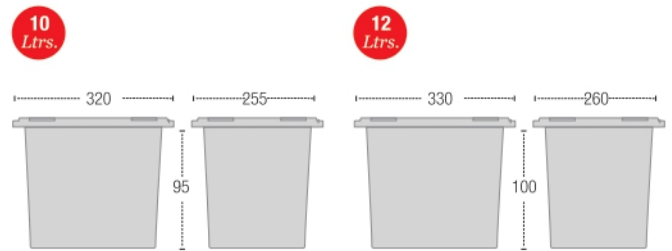

Capacity & Dimensions (in cms)

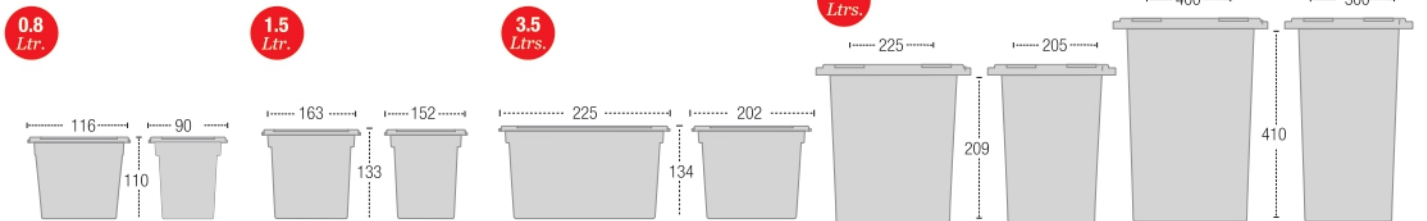

EXTRA LARGE SHARPS CONTAINERS

SC-30 - 30 Ltr.

SC-60 - 60 Ltr.

UV
STABLE

POLYMER

NON
FADING
COLOURS

ISO
13485:2013
Certified



FEATURES

- Meets Biomedical Waste Disposal Norms
- Solid and stable shape
- Translucent and Puncture resistant
- Ergonomic handle
- Wide opening (40x30cm)
- Temporary and Permanent closing facility
- Two anchors and hinge type hooks for attachment of lids.
- Maximum filling level indicator
- Hermetic and Leak proof closing
- No emission of any harmful gasses during the incineration process.
- Port hole sheet for safe deposit of waste.
- The Bins comply UN and NFX Standards of safety.
- Available in 30 Ltrs. & 60 Ltrs. capacity



Available Colour variants



Capacity & Dimensions (in cms)

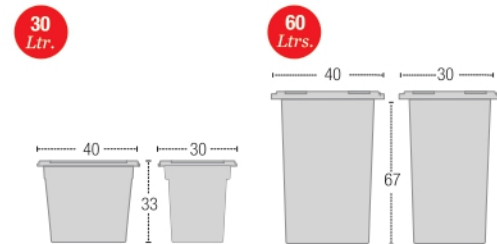

Port hole system and hinge type lid



Hermetic polyurethane gasket

SHARPS SAFETY BOX

Sharps Disposal Cardboard Box

- Bio-degradable board material with Lifting Handle.
- Safe aperture to receive Sharp Waste.
- Possible to close and seal the aperture any time during use.
- Maximum filling line marking
- Stable, spill proof & damage resistant.
- Pictorial instructions to use.
- Available in 5 Ltrs., 10 Ltrs. and 20 Ltrs. Capacity
- As per WHO Standards : WHO/PQS/E10/SB01.1



WASTE COLLECTION SYSTEM

DUO & TRIO

Stainless Steel body for easy collection of segregated waste as per color coding

UV STABLE

POLYMER

NON FADING COLOURS

ISO 13485:2013 Certified



FEATURES

- Stainless Steel body on castors.
- Easy collection of segregated waste.
- Swing lid system for easy deposit of waste.
- The Bins comply UN and NFX Standards of safety.
- Reusable and Autoclavable Plastic Bins as per BMW Color Coding
- Colour coded as per government norms.
- Easy removal of bins for cleaning.
- Capacity : 60 Ltrs. Each Bin



DUO



TRIO

Capacity & Dimensions

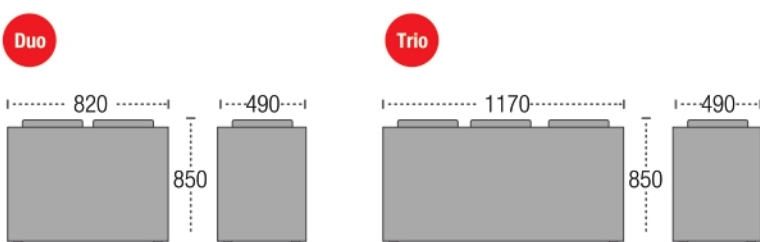

Colour coding options



WASTE SEGREGATION SYSTEM

WSS-1/30, 2/30, 3/30, 4/30

WSS-1/60, 2/60, 3/60, 4/60

Available in 30 Ltrs. & 60 Ltrs. capacity

UV
STABLE



NON
FADING
COLOURS

ISO
13485:2013
Certified



FEATURES

- Stainless Steel / Mild Steel trolley on castors.
- Foot operating system for touch-less opening of lid.
- The Bins comply UN and NFX Standards of safety.
- Reusable and Autoclavable Plastic Bins as per BMW Color Coding
- Bin Sizes 30 Ltrs. & 60 Ltrs.
- Bins can be interchanged as and when required.
- Available in One Bin, Two Bins, Three Bins & Four Bins Trolley Options.
- CE Certified.

Colour coding options



WASTE SEGREGATION SYSTEM WITH UTILITY COMPARTMENT

WSS-2/60, 3/60

30 Ltrs. capacity of Bin above Utility Compartment

30 Ltrs. capacity of Utility Compartment

60 Ltrs. capacity of Other Bins

UV
STABLE



NON
FADING
COLOURS

ISO
13485:2013
Certified



FEATURES

- Stainless Steel / Mild Steel trolley on castors.
- Utility Compartment for Storage.
- The Bins comply UN and NFX Standards of safety.
- Reusable and Autoclavable Plastic Bins as per BMW Color Coding
- Available in option of One Bin of 60 Ltrs. + One Bin of 30 Ltrs + Utility Compartment of 30 Ltrs. & Two Bin of 60 Ltrs. + One Bin of 30 Ltrs. + Utility Compartment of 30 Ltrs.
- CE Certified.

Colour coding options



WASTE SEGREGATION SYSTEM

WSS-1/22, 2/22, 3/22, 4/22

22 Ltrs. capacity of each bin

UV
STABLE



NON
FADING
COLOURS

ISO
13485:2013
Certified



FEATURES

- Stainless Steel trolley on castors.
- Foot operating system for touch-less opening of lid.
- Stainless Steel Bins Powder coated for Colour coding.
- Plastic Inner Bins with handle for Hygiene & Easy cleaning.
- 22 Ltrs. Capacity of each bin.
- Bins can be interchanged as and when required.
- Available in One Bin, Two Bins, Three Bins & Four Bins Trolley Options.
- CE Certified.

Colour coding options



WASTE BINS WITH FOOT PADDLES (PREMIUM)

FP 10P/ 20P / 35P

Built for efficient waste collection

UV
STABLE

POLYMER

NON
FADING
COLOURS

ISO
13485:2013
Certified



FEATURES

- Strong & long life Body.
- Foot Paddle for touch-less deposit of waste.
- Anti-Rust foot Paddle connector for longer life.
- Durable Hinge Design.
- Colour coded for waste segregation.
- Capacity 10 Ltrs., 20 Ltrs. & 35 Ltrs.



Colour coding options



Capacity & Dimensions

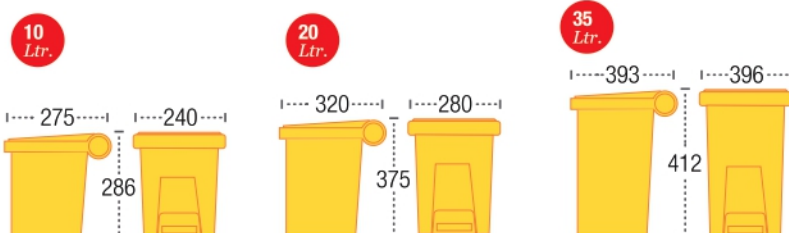

Foot Paddle for touch-less deposit of waste

WASTE BINS WITH FOOT PADDLES (DELUXE)

FP 10Dx / 15Dx / 20Dx / 30Dx / 45Dx / 60Dx

Built for efficient waste collection



FEATURES

- Light Weight, Elegant & Good Looking.
- Foot Paddle for touchless deposit of waste.
- Anti-rust foot paddle connector for longer life.
- Round and smooth edges.
- Colour coded for waste segregation.
- Capacity 10 Ltrs., 15 Ltrs., 20 Ltrs., 30 Ltrs., 45 Ltrs. & 60 Ltrs.

Colour coding options



Capacity & Dimensions

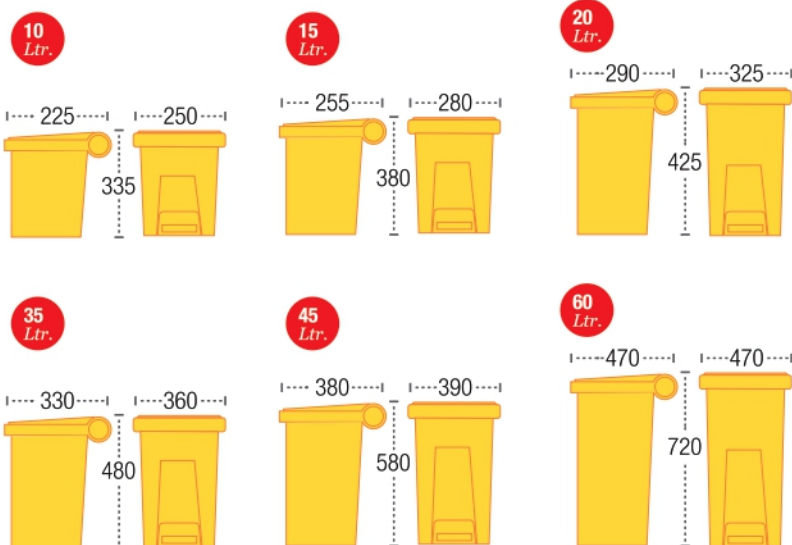

Foot Paddle for touch-less deposit of waste

WASTE BINS WITH FOOT PADDLES & WHEELS (PREMIUM)

FPW 90 / 120 / 240

Built for efficient, large capacity waste collection, roller bin is easily maneuverable and high on functionality. The tough construction makes it easier for users to move heavy loads to pick-up points.

FEATURES

- Strong & long life Body.
- Foot Paddle for touch-less deposit of waste.
- Anti-Rust foot Paddle connector for longer life.
- Side foot paddle for convenience of use.
- Heavy duty wheels for easy movement.
- Moulded-in Handles.
- Durable Hinge Design.
- Colour coded for waste segregation.
- Capacity 90 Ltrs., 120 Ltrs. & 240 Ltrs.



Colour coding options



Anti-rust Foot Paddle Connector

Capacity & Dimensions



Moulded-In Handles

Ergonomically designed grip for greater strength



Durable Hinge Design

WASTE BINS WITH WHEELS (DELUXE) - FOOT PADDLE OPTIONAL

FPW 120 / 240

Built for efficient, large capacity waste collection, roller bin is easily maneuverable and high on functionality. The tough construction makes it easier for users to move heavy loads to pick-up points.



FEATURES

- Light Weight & Elegant.
- Round & Smooth Edges.
- Injection Moulded.
- Wheels for easy movement.
- Optional Foot Paddle (Fabricated of M.S).
- Colour Coded For Waste Segregation.
- Capacity 120 & 240 Ltrs.

Colour coding options



Capacity & Dimensions

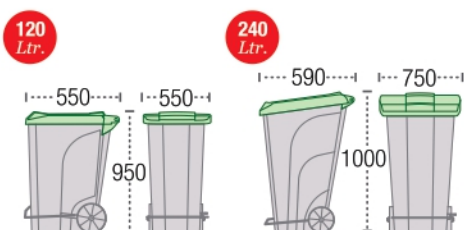

Anti-rust Foot Paddle Connector



Moulded-In Handles

Ergonomically designed grip for greater strength

Durable Hinge Design

HOOD TYPE OUTDOOR BINS

HTB-60 / 110

Built tough and convenient to maintain, the bins offers high capacity and easy access. Designed for high traffic public areas.



FEATURES

- Hood type top ensures long life in extreme conditions
- Grip of easy handling & better control.
- Colour coded as per waste management norms.
- Hanging facility on request.
- Also suitable for placing on ground.
- Capacity : 60 Ltrs. & 110 Ltrs.

Hooded Top

Self draining top ensures longevity in extreme outdoor weather conditions



Moulded-In Shoulder

Grip for easy handling and better control

Colour Coded

Available in multiple colours for sorting between biodegradable, hazardous, and recyclable waste.

Hanging Facilities

Designed for both hanging and placing on ground. Hanging allows for easy unloading and cleaning.



Liners enable easy disposal and increase the life of the bin.

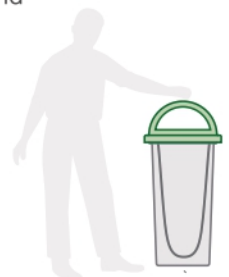

Colour coding options



Capacity & Dimensions

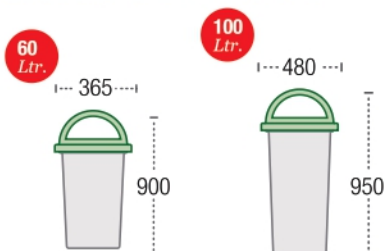

MULTI UTILITY CARTS

MUC 60 / 90 / 250 / 300 / 400

Built for moving large, heavy loads, ideal for usage in both indoor and outdoor spaces

UV
STABLE

POLYMER

NON
FADING
COLOURS

ISO
13485:2013
Certified



FEATURES

- Built for large & Heavy Loads
- Suitable for indoor as well as out door use.
- Compact design for all servicing areas & Lifts
- Ribbed form for high structural strength.
- Mild Steel painted trolley with wheels.
- Extra strength due to Mild Steel Trolley.
- Easy to use Handle.



Colour coding options



Capacity & Dimensions

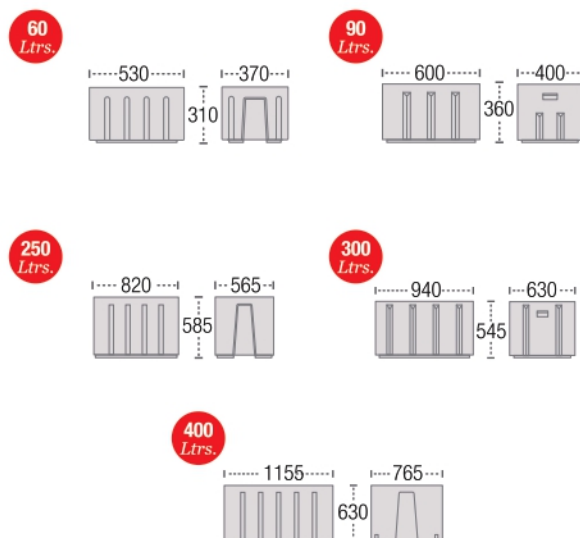

Compact Design

Designed to fit all servicing areas and lifts

Ribbed Form

Durable with high structural strength

Load Bearing Trolley

Ensuring stability while loading and transferring

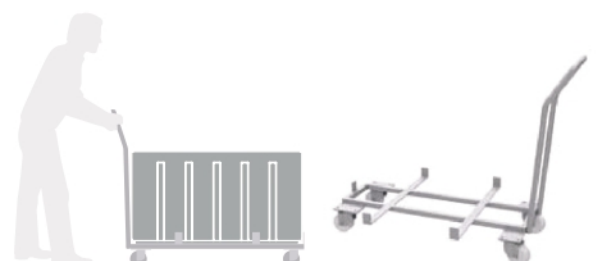

BULK WASTE COLLECTION TROLLEYS

BWCT 650

Provided with wheels and handles to manage unloading and cleaning easily and efficiently.

UV
STABLE

POLYMER

NON
FADING
COLOURS

ISO
13485:2013
Certified



FEATURES

- Ideal for Bulk waste management
- Hinged Cover ensures hygiene & easy excess for emptying.
- Mounted on Mild Steel painted load bearing trolley with wheels.
- Mild Steel Trolleys enhances the stability & strength.
- Anti microbial treated models also available on request.
- Capacity 650 Ltrs.



Colour coding options



Large Capacity

Ideal for bulk waste management

Hinged Cover

Easy access while emptying, and ensures hygiene over long period

Load Bearing Trolley

Ensuring stability while unloading and transferring

Capacity & Dimensions

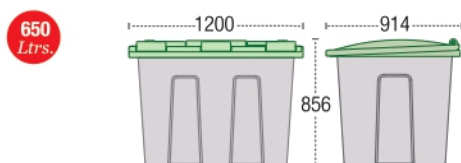

MEDICAL LINEN TROLLEY (COLOUR CODED)

LNT 2/56



FEATURES

- Two 56 Ltrs. (each) Bags Linen Trolley.
- Colour Coded Bags for Segregation of dirty and clean Linen.
- Easily Removable & Washable Bags.
- Stainless Steel Trolley.
- 4 Noiseless Castors / Wheels (2 With Lock)



Capacity & Dimensions

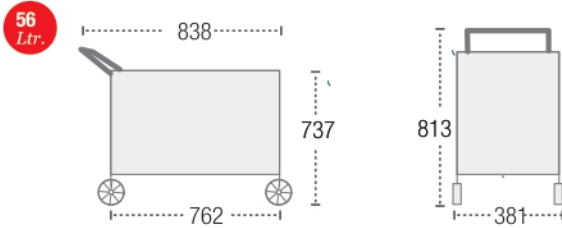

Colour coding options



LAUNDRY CARTS

LC 430

The tough construction ensures long-lasting use. It's mobility and structure makes it helpful in loading and emptying.

FEATURES

- Stable and Sturdy Laundry carts.
- Tough construction ensures long life.
- Mild Steel painted trolley with wheels for load bearing.
- Extra strength due to Mild Steel Trolley.
- Moulded top shoulder provide comfortable grip while handling.
- Capacity 430 Ltrs.



Capacity & Dimensions

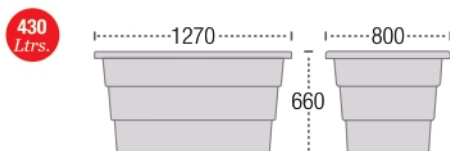

Colour coding options



EMERGENCY TROLLEY / CRASH CART (ABS)

ECT-7500

UV
STABLE

POLYMER

NON
FADING
COLOURS

ISO
13485:2013
Certified



FEATURES

- High quality ABS Body with raised edge design.
- Stainless Steel Guard Rail.
- High quality Scratch-proof Aluminum Columns for extra strength.
- 5 Drawers with Flexible & adjustable Inner partitions.
 - 2 Small Drawers
 - 2 Midsize Drawers
 - 1 Big Drawer
 - Label card holders on drawers
- 1 Defibrillator Shelf & 1 Extra Sliding Side Shelf.
- 1 CPR Board, Oxygen Cylinder Holder.
- 1 IV Pole, 1 Utility Container, 1 Sharp Container, 2 Dust Bins.
- Power Outlet & Hooks.
- Four Noiseless Castors (Front Two with Brakes).

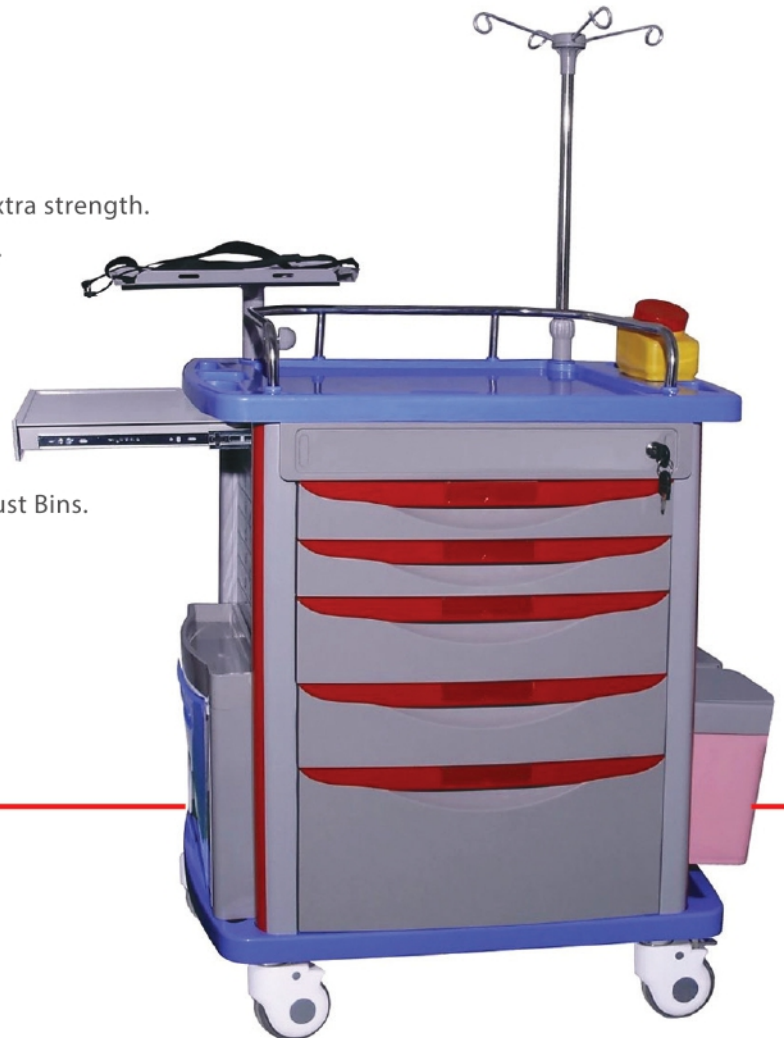

Dimensions

- Working Table: 750 x 475 x 960mm
- Two small drawer panel height: 80mm, inner utility size: 424 x 375 x 68mm
- Two middle drawer panel height: 120mm, inner utility size: 424 x 375 x 110mm
- One big drawer panel height: 240mm, inner utility size: 424 x 375 x 220mm
- ABS drawers with 3x3 dividers for arbitrary partitioning
- Package size: 790 x 540 x 980mm

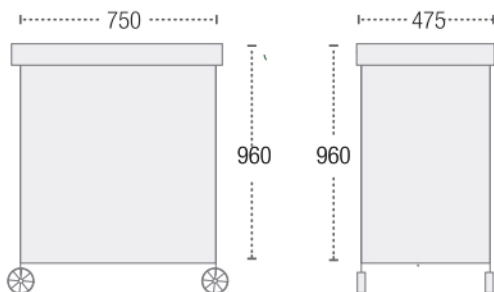

EMERGENCY TROLLEY / CRASH CART (S.S / M.S)

ECT-6500-SS/MS



FEATURES

- High Quality Stainless Steel / Mild Steel Body with raised edge design.
- Stainless Steel / Mild Steel Guard Rail.
- High Quality S.S / M.S columns for Extra Strength.
- 6 Nos. Medical Grade Plastic Drawers with central locking system.
- 6 Nos. Color coded open utility bins (interchangeable).
- 1 Instrument Tray (S.S / M.S).
- 1 Large Storage Shelf at the bottom.
- Strong Handle (S.S / M.S).
- 4 Prongs IV Pole.
- 4 Wall Guard Bumpers.
- Four Noise Less, High Quality, ABS covered Wheels (Front Two with Brakes)



Dimensions

- Working Table Top: L686 mm x W571 mm
- Full Trolley Dimension When Assembled: H1600mm (Excluding IV Pole) x L686mm x W571 mm

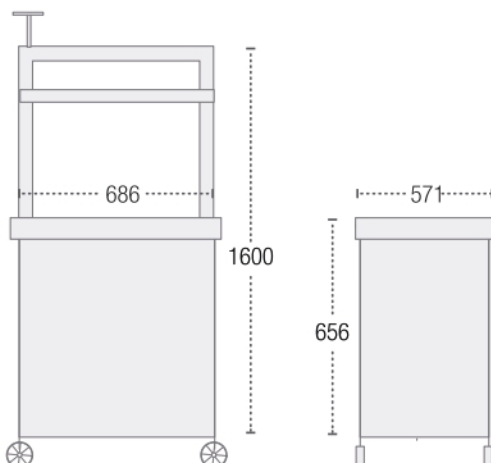

HYPOCLEAN AUTOMATIC

Liquid Waste Treatment System

ISO
13485:2013
Certified



FEATURES

- Fully Automated Liquid Waste Treatment System.
- Treats & Disposes Medical Liquid waste as per BMW management Guidelines.
- 7" (Inches) Color Display & Touch Screen Control.
- Real-time Level Indicators for Waste & NaClO (Sodium Hypo Chloride).
- Automatic Dosing of NaClO.
- Automatic pH Value Sensing.
- Audio Visual alarm For Low Levels of NaClO.
- Audio Visual alarm to avoid overflow of waste processing Unit.
- Continuous Treatment Cycle ensures uninterrupted working.
- Regular controlled dosing ensures complete disinfection.
- Automatic Draining of Treated Waste to Sewage Line at regular intervals.
- Elbow operated tap with washing bay.
- Stainless Steel Body of 304 Grade for very long life.
- Chemical resistant and anti-corrosion tanks.
- Tank Capacity 100 Ltrs., 150 Ltrs. and 175 Ltrs. per cycle.
- System manual override in case of emergency.



Tap

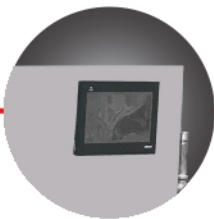

Touch Screen
Control Panel



Washing Bay



Level Indicators

for Waste & NaClO (Sodium Hypo Chloride)

Automatic Draining of Treated Waste

to Sewage Line at regular intervals

Continuous Treatment Cycle

Ensures Uninterrupted Working



HYPOCLEAN MANUAL

Liquid Waste Treatment System

ISO
13485:2013
Certified



FEATURES

- Manual Liquid Waste Treatment System.
- Treats & Disposes Medical Liquid waste as per BMW management Guidelines.
- Provision for pH Value Sensing.
- Continuous Treatment Cycle ensures uninterrupted working.
- Manual controlled dosing ensures complete disinfection.
- Manual Draining of Treated Waste to Sewage Line at regular intervals.
- Elbow operated tap with washing bay.
- Stainless Steel Body of 304 Grade for very long life.
- Chemical resistant and anti-corrosion tanks.
- Tank Capacity 50 Ltrs., 75 Ltrs. and 100 Ltrs. per cycle.

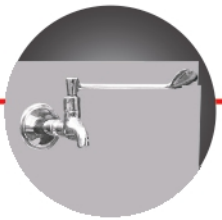

Tap



Washing Bay

Level Indicators

for Waste & NaClO (Sodium Hypo Chloride)

Manual Draining of Treated Waste

to Sewage Line at regular intervals

Continuous Treatment Cycle

Ensures Uninterrupted Working



STEAM AUTOCLAVABLE BAG

SA-Bags

ISO
13485:2013
Certified



FEATURES

- Steam Autoclavable
- Environment Friendly
- Chlorine Free
- Cytotoxic
- Meets all BMW Disposal Norms
- Certified & Tested by Leading test Agencies
- Available in various colours & sizes



WASTE COLLECTION BAG

BMW-Bags

Biodegradable & Non Chlorinated

FEATURES

- Biodegradable
- Environment Friendly
- Chlorine Free
- Cytotoxic
- Meets all BMW Disposal Norms
- Certified & Tested by Leading test Agencies
- Available in various colours & sizes



Hail Mediproducts Private Limited

WH-2, First Floor, Phase-1, Mayapuri Industrial Area
New Delhi-110064 (INDIA)

Mobile: +91-9810077648
Phone: +91-11-40197171, 40197272
Email: info@hailmediproducts.com



www.hailmediproducts.com
www.socleanindia.com

SoClean®