



2025
Edition

Timus Tooling System Pvt Ltd



AN ISO 9001 : 2015 CERTIFIED COMPANY

Mod.Furn

CUT, EDGE , COMPLETE

Where quality is never compromised. . .

PANEL PROCESSING MACHINERY



15

Celebrating 15 Year of

Leading the Way Forward

www.timustooling.com



Sliding Panel Saw Machine



Soft Package Delivery Size	3250X1100x1100mm ³
Installation Size	3250X3500X870mm ³
Machine Weight	795Kg
Dimension Of Slider	3200X400/375mm ²
Maximum Processing Length	3100mm
Maximum Processing Width	1200mm
Maximum Processing Thickness	75mm
Saw Blade Diameter	300-350mm
Main Shaft Diameter	30mm
Blade Angle	45°-90°
Spindle Speed	3600-6000RPM
Main Motor Power	7.5HP
Scoring Saw Diameter	120mm
Speed of Scoring Saw Blade	7200mm
Auxiliary Shaft Diameter	20mm
Auxiliary Motor Power	1.5HP
Voltage	380v Standard, 220v As Per Requirement

TIMUS CNC PANEL SAW



Apply to processing all kinds of density boards, shaving boards wood-based panels, ABS panels, PVC panels, organic glass plates and solid wood and others with wood structure and similar hardness

Movable table guide track is plating chromium steel balls structure, exact and durable

Made of high-strength extruded aluminium alloy, movable table is high in strength and won't bend

With oxidation treatment, movable table surface is beautiful and hardwearing.

LED control panel can accurately display 3 axis of blade height, tilting angle and rip fence position.

Installation Size	3250X3250X900mm³
Dimension Of Slider	3200X420mm²
Gross Cut Capacity	3200mm
Width of Cut between saw blade and rip fence	1220mm
Saw Blade Diameter	300mm (250-300mm)
Height of Cut	75mm
Speed of Main Spindle	4000-6000RPM
Spindle Diameter	30mm
Tilting Saw Blade	45°-90°
Main Motor	5.5kW
Scoring Saw Blade Diameter	120mm
Speed of Scoring Saw Spindle	8000RPM
Scoring Spindle Diameter	20mm
Scoring Motor	0.75kW
Rip Fence Movement	Auto
45° Tilt	Auto
Cross Cut Fence Read Out	Digital
PLC Touch Screen	Yes
Cutter Up Down Movement	Auto



Manual Edge Banding Machine



Model	TT.ME 515A	TT.ME 515B	TT.ME 515C
Type	with rotary auxiliary table	Basic Model	with auxiliary table
Panel Length	Min. 150mm	Min. 150mm	Min. 150mm
Panel Thickness	10 -50mm	10 -50mm	10 -50mm
Edge Thickness	0.4-3mm	0.4-3mm	0.4-3mm
Feeding Speed (stepless motor drive)	1-7m/min (Optional 1-10m/min)	1-7m/min (Optional 1-10m/min)	1-7m/min (Optional 1-10m/min)
Feeding Speed (Inverter motor drive)	1-15m/min	1-15m/min	1-15m/min
Weight	192/ 230kg	168/ 200kg	175/ 210kg
Motor Power	2kw	2kw	2kw
Overall size	1110*830*1000mm	950*750*1000mm	1000*830*1000mm

Timus automatic edge banding machine (TIMUS-1600+)



* PRODUCT FUNCTION

- Automatic feeding
- Automatic end cutting
- Double-sided trimming
- Glue removal
- Double-sided polishing

Overall Size	1600X600X960 mm
Weight	150 Kg
Total Power	5kW
Width	50mm
Edge Banding Speed	0-13m/min
Voltage	220V



Through Feed Edge Banding Machine (3600 Edge Pro)



7 FUNCTION

Pre milling , Gluing , Edge Counting, Front and end cutting, Fine trimming , Scraping , Polishing

TIMUS 3600 EDGE PRO	WITH 10" TOUCH DISPLAY & Edge Counting Meter 3800*800*1450mm
Machine size	
Edge Thickness	0.4-3mm
Edge banding height	12 - 100 mm
Workingpiece thickness	08-55mm
Panel Feed Speed(m/min)	18m/min
Total power	12 Kw
Machine weight	1200 Kg
Air pressure	0.6 - 0.8 Mpa
Mini work Panel Width	> 80mm
Mini work Panel Length	>120 Mm
Voltage	380V / Hz

Through Feed Edge Banding Machine (7300A J/C TYPE)



. Board pre-milling system · Edge banding system · Profiling Bonding System			
. Profiling bonding auxiliary heating system · End cutting system · Trimming system			
. Trimming system · Secondary trimming system · Glue removal			
. Polishing system			
· One-key switch between J/C mode			
Machine size:5600*900*1420mm			
Soft forming J/C type automatic edge banding machine			
Soft forming J/C type integrated automatic edge banding machine			
Product power list			
Board pre-milling system	8kw	Edge banding system	1kw
Profiling bonding auxiliary heating system	3.2kw	End cutting system	1.8kw
Polishing system	1.6kw	Delivery system	0.35kw
Rated voltage	380v	Edge band thickness:	0.5mm
Edge band width:	40mm-70mm	Profiling bonding system	2.15kw
Type of wood processing	Multilayer board, ecological board, particle board, compression board	Glue type	Granular glue type: (180°C~210°C/PUR)
Trimming system	1.8kw	Total power	20kw

Throughfeed Edge Banding Machine (TT-468J)



FUNCTION.

PRE MILLING , GLUING PASTING, END CUTTING, TOP AND BOTTOM ROUGH AND FINE TRIMMING , CORNER ROUNDING , SCRAPING , BUFFERING, & AIR POLISING

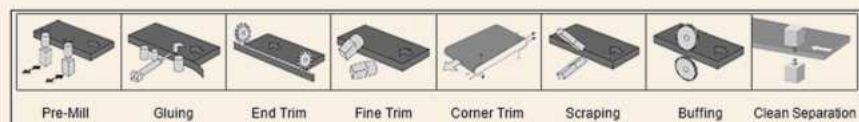

brand name	Timus TT-468J
Size	5500x900x1500mm
Feed Speed	12m/min,16m/min,20m/min
Panel Thickness	10-60mm
Edge Thickness	0.4-3mm
Working Pressure	0.6Mpa, 0.8Mpa
voltage	220v/380v as your requirement
power (kw)	13 kw
Single gross weight	1500 Kg
Warranty	1 Year
Panel Length Minimum	>=150mm
Panel Width Minimum	>=60mm



Throughfeed Edge Banding Machine

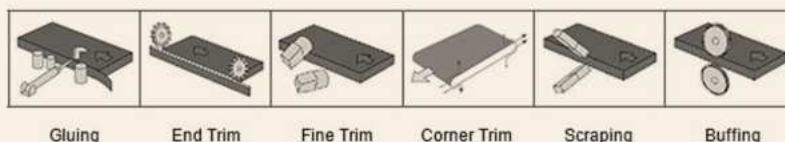

Model	TT-3650 EDGE 5 PRO	TT-3650 EDGE 6 PREMIUM
Function	Guling, End cutting, Fine trimming, Scraping, Buffing	Guling, End cutting, Fine trimming, Corner Rounding, Scraping, Buffing
Panel Length	Min. 140mm	Min. 140mm
Panel Width	Min. 60mm	Min. 60mm
Panel Thickness	10-50mm	10-50mm
Edge Thickness	0.4-3mm	0.4-3mm
Feeding Speed	13 or 18m/min	13 or 18m/min
Working Pressure	0.7Mpa	0.7Mpa
Weight	860kg	1150kg
Motor Power	7kw	11kw
Overall Size	3440*750*1550mm	3800*750*1360mm

Single Head Multiboring Machine



Functions

Head assembly tilts 0-90°,
Horizontal & Vertical works
in 2 operations with
different settings

Max. working thickness	70
Max. size of workpiece	2000X800mm ²
No. of spindle head	1
No. of spindles per head	21
Shank diameter of drill	10mm
Drilling depth	0-50mm
Elect. Motor / Total Power	1X2=2HP
Machine dimension (L x B x H)	1070X1020X1300mm ³
Approx. net weight	400Kg

Double Head Multiboring Machine



Functions

Head assembly tilts 0-90°, Horizontal & Vertical head works simultaneously one by one on the same setting in single operation

Max. working thickness	70
Max. size of workpiece	2000X640mm ²
No. of spindle head	2
No. of spindles per head	21
Total Spindle	21+21=42
Minimum Centre Distance Between 2 Vertical Heads	392
Maximum Centre Distance Between 2 Vertical Heads	472
Drilling depth	0-50mm
Elect. Motor / Total Power	2X2=4HP
Machine dimension (L x B x H)	2000X1220X1340mm ³
Approx. net weight	500Kg

C Type Double Head Multiboring Machine

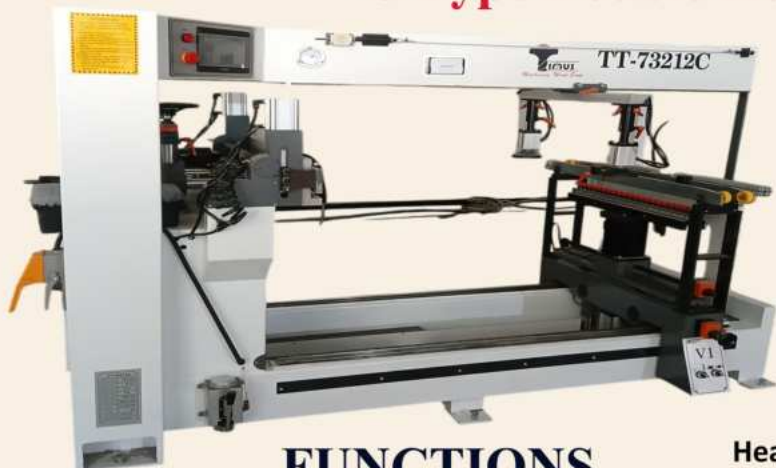

FUNCTIONS

Head assembly tilts 0-90°, Horizontal & Vertical head works simultaneously one by one on the same setting

Model	TT-73212C
Max. drilling diameter	35mm
Max. drilling depth	60mm
Max. processing hole distance	0-1200mm
Number of drills	21*2 rows
Spindle speed	2840rpm
Motor power	3kw
Working Air pressure	0.6-0.8Mpa
Overall size	2600x1200x1600mm
voltage	380v
Weight	685kg

Three Head Multiboring Machine



Functions

Semi-Automatic Boring machine equipped with 1 horizontal & 2 rotating vertical boring heads with 21 spindles for executing holes in a line for wardrobe side processing of knock down furniture.

Max. working thickness	60
Max. size of workpiece	1850X640mm ²
No. of spindle head	3
No. of spindles per head	21
Total Spindle	21+21+21=63
Minimum Centre Distance Between 2 Vertical Heads	150
Maximum Centre Distance Between 2 Vertical Heads	1650
Drilling depth	0-50mm
Air Pressure Required	6-7Kg/cm ²
Elect. Motor / Total Power	3X2=6HP
Machine dimension (L x B x H)	3000X3050X1500mm ³
Approx. net weight	900Kg

Timus Blue 50



MODEL	BLUE 50	BLUE 50A
Pressure board dimensions	2500x1300mm	2500x1300mm
Max. pressure	60 Tons	60 Tons
Max. opening	1250mm	1250mm
Power req.	5 HP	5 HP
Overall Dimensions (LxWxH)	3000 x 1300 x 3050mm	3000 x 1300 x 3050mm
Cylinder stroke	700mm	1000mm
Weight	2600-2800Kg	2600-2800Kg

Timus Blue 100



MODEL	BLUE 100	BLUE 100A
Pressure board dimensions	2500x1300mm	2500x1300mm
Max. pressure	120 ton	120 Ton
Max. opening	1250mm	1250mm
Power req.	5 HP	5 HP
Overall Dimensions (LxWxH)	3000 x 1450 x 3000mm	3000 x 1450 x 3000mm
Cylinder stroke	700mm	1000mm
Weight	3800-4000Kg	3800-4000Kg

Timus Hot Press Machine



MODEL	THP100
Size of hot plate	2500 x 1300mm
Total thrust	120 tons
Cylinders	6 Nos
Piston dia	100mm
Stroke	300/450mm
Motor / RPM	5 HP/1440
Electric elements	22kw
Heating of machine	Aluminium
Height of machine	1900mm
Movement	Hydraulic
Mode of heating	Electric/Oil
Heating temp	150° C
Maximum pressure	100kg/cm²
Job completion time	5 minutes
Day light	380mm
Press size	3600x1550x1900mm

Timus Vaccum Press



MODEL	TVP 2500X1300
Working table	1
Working class	2500 x 1300mm
Working piece thickness	80mm
Approximate weight	1300kg. (approx)
Working cycle time	3-5 min
Application board	MDF/HDF
Material	PVC Film
Power required	18 kw

CNC Router Nesting Machine



Model	TT-1325ATC	TT-2030ATC
X working area	1300mm	2000mm
Y working area	2500mm	3000mm
Z working area	200mm	200mm
Max. working speed	45m/min	45m/min
Max. engraving speed	25m/min	25m/min
Repositioning accuracy	±0.05mm	±0.05mm
Command	G code	G code
Spindle	9kw air cooled spindle	9kw air cooled spindle
Spindle speed	0-18000rpm	0-18000rpm
Packing size	3800*2250*2250mm	4300*2280*2250mm

Timus Pin Router



Model No	Unit	TPR 800x600
Work table size	mm	800 x 600
Max. cutting thickness	mm	60
Lifting travel of work table	mm	130
Maximum table tilt	degree	45°
Throat clearance	mm	750
Spindle speed	rpm	8000 / 16000
Guide pin diameter	mm	6 & 12.7
Shank diameter of cutter	mm	12
Spindle actuation	-	Pneumatic
Compressed air requirement	hp/kg/cm ²	1.5 / 7.0
Total Power	hp / rpm	4 / 1400 & 2800
Machine dimension (L x B x H)	mm	1500 x 900 x 1750
Approx. net weight	kg	500

CNC Engraving Router



Working Size(x, y, z)	1300*2500*300
Max. Moving Speed	10000mm/min
Reposition Accuracy	<0.05mm/300mm
Max Engraving Speed	6000-24000 RPM
Spindle Power	3.5kw Air Cool Spindle
Motor	CW 450B Stepper Motor
Control System	NC STUDIO
DSP	Optional
Inverter	Best
Platform	Aluminium
Cross Beams	Steel
Warranty	One Year
Driver	YAKO 2608 Z Axis 200mm
Tool Diameter	Ø3.175,Ø4,Ø6,Ø12
Dust Collector	Optional
Working Voltage	/50HZ(AC Can Use 380v)
X, Y, Z Guide Rail	China Brand 20
Engraving Instruction	HPGL, G Code
Rail Guide	20mm

CNC LASER Machine (TIMUS CL-1325)

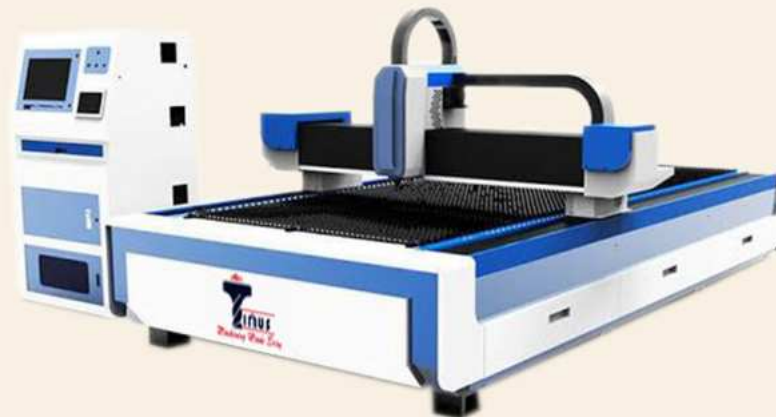

LASER POWER	130 WATT
LASER TYPE	CO2 GLASS LASER
POWER SUPPLY	AC220V ± 10%, 50 HZ
LOCATION PRECISION	0.01mm
GROSS POWER	1250W
OPERATION HUMIDITY	0-45DIG
ENGRATION SPEED	0-24000(mm/Min)
COOLING SYSTEM	WATER COOLING
MIN. LASER SIZE	1X1 mm
GRAPHIC FORMAT SUPPORTED	BMP, ZIP, JPEG, PCX, TGA, TIFE, PLT, CDR, DMG/DDF
APPLICABLE MATERIAL	MDF, ACRYLIC, REDIUM, RUBBER etc.

Beam Saw



Computer Controlled Beam Saw Machine	
MODEL	TBS 3280 AUTO
Saw cutting length	3280 mm
Saw cutting thickness	90mm
Diameter of main saw blade	Ø 400mm
Diameter of main saw blade shaft	Ø 60mm
Revolving speed of main saw blade	3930 r/min
Diameter of scoring saw blade	Ø 180mm
Diameter of scoring saw blade shaft	Ø 30 mm
Revolving speed of scoring saw blade	6500r/min
Advance speed of saw base (stepless)	9-50 m/min
Back speed of saw base	100 m/min
Drive motor of saw base	1 kw
Drive motor of main saw blade	15 kw
Automatic feeding motor	1.5 kw
Automatic feeding speed	50m/min
Operating pressure	5 ~ 8 kg/cm
Net weight of device	62420 kg
External dimensions (L x W x H)	5830 x 6630 x 1810 mm



Hinge Drilling Machine



Model	TT.HB 73031	TT.HB 73032
Max.drilling diameter	35mm	35mm
Max.drilling depth	60mm	60mm
Vertical spindle heads	220-815mm	220-750mm
Number of drills	3	3 * 2heads
Spindle speed	2840rpm	2840rpm
Motor power	1.5kw	3kw
Working pressure	0.6-0.8Mpa	0.6-0.8Mpa
Overall size	800*750*1700mm	1700*850*1700mm
Packing size	970*760*1650mm	1720*1050*1690mm
Weight	150kg	260kg



Portable Hinge Drilling Machine

Machine Size	450X500X550
Weight	25Kg
Rated Power	750W, 220V 1Phase
Hinge Bit	35mm
Drill Depth	40mm
Speed	2880RPM

Six Sided Drilling Machine



Panel length	200-3000mm
Panel width	30-1200mm
Panel thickness	10-60mm
Max speed	135/135/75/30m/min
Main spindle power	3.5kw×2
Max rotation speed	18000rpm
Upper vertical drill	18×2
Upper vertical drill	X direction : 6×2 Y direction : 2×2
Lower vertical drill	9
Rotation speed	5000rpm
Dust collector	Top dust collectorφ150mm×2 Bottom dust collectorφ125mm
Total power	21.93kw
Overall dimension	6150×2806×2325mm
Net weight	3750kg

Auto TCT Top and Face Grinding Machine



Size	1070X930X1290mm ³
Saw Blade Size	150-800mm
Grinding Wheel Size	150X32X10mm
Move the Saw Tooth Speed	0-55 Tip/min
Motor Speed	5000RPM
Grinding Wheel Motor Power	550W
X-Axis Motor Power	100W
Z-Axis Motor Power	1000W
Y-Axis Motor Power	100W
Weight	245Kg

Fully Automatic TCT Top and Face Grinding Machine



Size	1810X1650X110mm ³
Processing Dia of Blade	80-800mm
Bore of Blade	10-200mm
Diameter of Grinding Wheel	125mm
Bore of Grinding Wheel	32mm
Grinding Speed	25Tip/min
Grinding Wheel Speed	5000-10000RPM

TCT Tip Brazing Machine



Processing Dia of Blade	100-700mm
Bore of Blade	6-160mm
Carbide Tip	2-6mm
Hook Angle	10°-35°
Voltage	220V
Brazing Voltage	2.7V
Connected Load	1.2kW

Timus Portable TCT saw Sharpening Machine



Voltage	250w/370w/550w
Speed	2850 rpm
Diamond wheel	125*10*32*2 mm
Packing size	720*430*500 mm
Grinding range	80-700 mm
Angle	Left 30° Right 40°
Adjust angle	-20° --- +20 °
Gorss weight	30-32 kgs

Timus Mini Panel Saw



Mini Panel Saw 5 In One



Table Size	2800X110 mm
Weight	110Kg
Rated Power	240V 1Phase
Cutting Width	1250 mm
Up-Down movement of saw blade	Manual
Motor for saw blade	1HP
Max. Cutting Depth 45°	50mm
Max. Cutting Depth 90°	90mm
Tilt	45°
Saw Blade Speed	3200 RPM

Timus Mini Panel Saw With Rocker



Table Size	2800X110 mm
Weight	125Kg
Rated Power	240V 1Phase
Cutting Width	1250 mm
Up-Down movement of saw blade	Manual
Motor for saw blade	1HP
Max. Cutting Depth 45°	50mm
Max. Cutting Depth 90°	90mm
Tilt	45° - 90°
Saw Blade Speed	3200 RPM

Timus Portable edge banding



Size	350X350X400mm ³
Weight	14Kg
Rated Power	750W
Edge Sealing Speed	2-6m/min
Heating Time	5-10min
Continuous Working Time	<10H

Timus mini edge banding



AUTOMATION GRADE	MANUAL	VOLTAGE	220VOLTS
PHASE	1 PHASE	EDGE THICKNESS	8-50MM
WEIGHT	30KG	EDGE BELT THICKNESS	8-50MM
SIZE	500X500MM PACKED SIZE	FEEDING SPEED	VARIABLE
AIR PRESSURE	4-6BAR	GLUE POT CAPACITY	SMALL SIZE 1-2KG APPROX
FREQUENCY	50HZ	WORKING PRESSURE	4-6BAR
HEATING ELEMENT	MULTIPLE	TAPE THICKNESS	UPTO 3/3MM

GLUE APPLICATOR

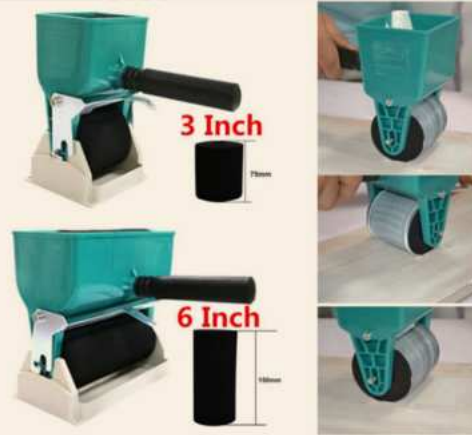

SIZE AVAILABLE (6") AND (3")

Glue Capacity 6" -- 900mL

Glue Capacity 3" -- 450mL

SPONGE
1 pcs. FREE
INSIDE

Glue applicator foam also available
seperately

Pvc Corner Rounding Trimmer



Function

Pvc Edge Corner Rounding

Rated Power

240V 1Phase 0.5HP

2 in 1 Portable Trimmer

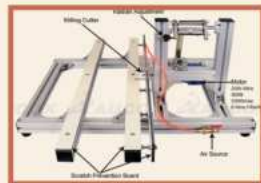
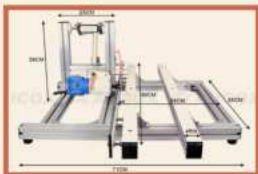

Voltage:220V

Power:0.35KW

Cutter Speed:4m/min

Weight:18kg

Size:87x73.5x18cm

Max Width:2400mm

Max Thickness:80mm

Max Length:2400mm

Pneumatic Side Hole Drill Machine



Power Consumption	500W
Voltage	220V
Usage/Application	Drilling Wood Panel Holes
Drilling Depth	4 Cm
Automation Grade	Semi-Automatic



Timus Portable Jointing Slotting Machine

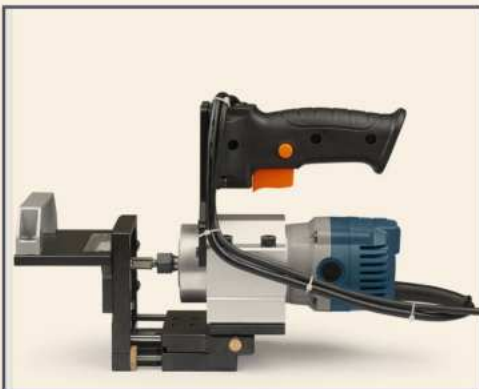

Model Name/Number	TS111N
Brand	Timus
Automatic Grade	Semi-automatic
Usage/Application	Industrial
Input Power	800 W
Weight	2.6 kg
No-load Speed	10000/min
Max. Slotting Depth	20 mm



DUST COLLECTOR



Also available in single bag



Model	TT.DC 9030	TT.DC 9040	TT.DC 9055
Motor Power	3kW	4kW	5.5kW
Voltage/Frequency	380v 220v /As For Requirement	380V/50Hz/3Phase	380V/50Hz/3Phase
Air Volume	3150m ³ /Hr	4450m ³ /Hr	5500m ³ /Hr
Suction Holes Diameter	φ4" x 3pcs.	φ4" x 3pcs.	φ4" x 6pcs.
Bag Diameter	φ480mm x 4pcs	φ630mm x 4pcs.	φ630mm x 4pcs.
N.W/ G. W	55/70Kg	95/104kg	120/127Kg
Packing Dimension	1200x560x530mm	1450x730x710mm	1450x730x710mm



Model	TT.DC 9011-24	TT.DC 9011-48
Motor Power	15HP	15HP
Voltage / Frequency	380V 50hz 3phase	380V 50hz 3phase
Air Volume	11000m ³ /Hr	12000m ³ /Hr
Air Speed	40 – 45 m/s	42 – 47 m/s
Suction Holes Diameter	5 x 150	5 x 150
Dimensions	2350 x 1000 x 3100mm	3600 x 1000 x 3100mm
Weight	400kg	450kg



WOODWORKING MACHINERY SPARE PARTS

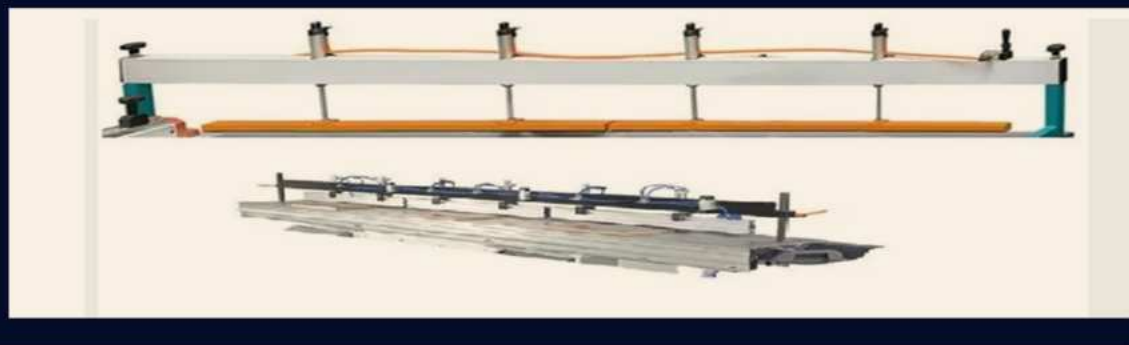

Hot Melt Adhesives



Allen Keys



Portable Router/Trimmer



End Cutter & Manual Edge Trimmer Scraper / Single Side Edge Trimmer



Heavy Duty End Cutter



Pneumatic Trimmer for PvC



Drill Machine



Reciprocating Compressor



Grinding Wheel



Welding Machine



WOODWORKING HAND TOOLS AND ACCESSORIES



TIMUS WOODWORKING TOOLS

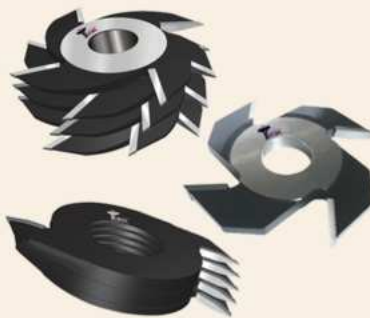
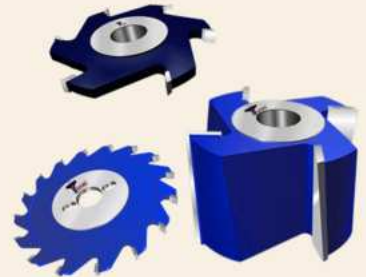
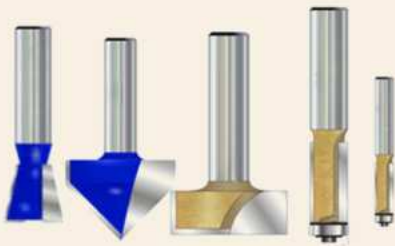

For more information ask for Timus tools catalogue

Semi-Auto Sharpening Machine Timus Pipe Cutting Machine



CNC Auto HSS Sharpening Machine



Timus Cold Saw Blades







Where quality is never compromised...

AN ISO 9001 : 2015 CERTIFIED COMPANY



Countries We Are Outsourcing From



**Kh.NO-835 Mandi Village Dera Mandi Road Near
Janki Max Hospital ND-110047**

☎ +91 9266384544, +91 9717358599

✉ timustooling@hotmail.com

www.timustooling.com