

# GLOBAL PRINTECH GRAPHICS

## INDEX

<b>PRINTING RUBBER BLANKETS</b>	<b>1-4</b>
<b>BLANKET BARS</b>	<b>5</b>
<b>KOMORI SPARE PARTS AND CONSUMABLES</b>	<b>6-9</b>
<b>HEIDELBERG SPARE PARTS AND CONSUMABLES</b>	<b>10-11</b>
<b>KODAK MACHINES &amp; SPARE PARTS/CONSUMABLES</b>	<b>12-13</b>
<b>WEB OFFSET SPARE PARTS</b>	<b>14-15</b>
<b>LED UV CURING SYSTEM/ UV-LED LAMPS</b>	<b>16</b>
<b>SLOW-DOWN BELTS</b>	<b>17</b>
<b>PAPER CUTTING KNIFE</b>	<b>18</b>
<b>CREASING MATRIX ACCESSORIES</b>	<b>19</b>
<b>DOCTOR BLADE</b>	<b>20</b>
<b>CHILLING UNIT FILTERS</b>	<b>21</b>
<b>MANILA ART PAPER , ANTI MARKING FILM &amp; POLICROM SELF ADHESIVE</b>	<b>22</b>
<b>FINITO UNDER BLANKET PACKING</b>	<b>23</b>
<b>BOTTCHER MAINTENANCE PRODUCTS &amp; CHEMICAL</b>	<b>23A</b>
<b>BOBST MACHINE SPARE PARTS</b>	<b>24</b>
<b>WASHUP BLADE FOR INK ROLLER</b>	<b>25</b>
<b>HAND STRIPPING MACHINE</b>	<b>26</b>
<b>FALCON PRESS-ROOM CHEMICALS</b>	<b>27</b>
<b>PLATE SUCKERS</b>	<b>28</b>
<b>VISKOVITA SPONZES</b>	<b>29</b>
<b>DRILL BIT</b>	<b>30</b>
<b>PH METER &amp; EYE GLASSES</b>	<b>31</b>
<b>STITCHING WIRES</b>	<b>32</b>



# PHOENIX *Xtra* BLANKETS

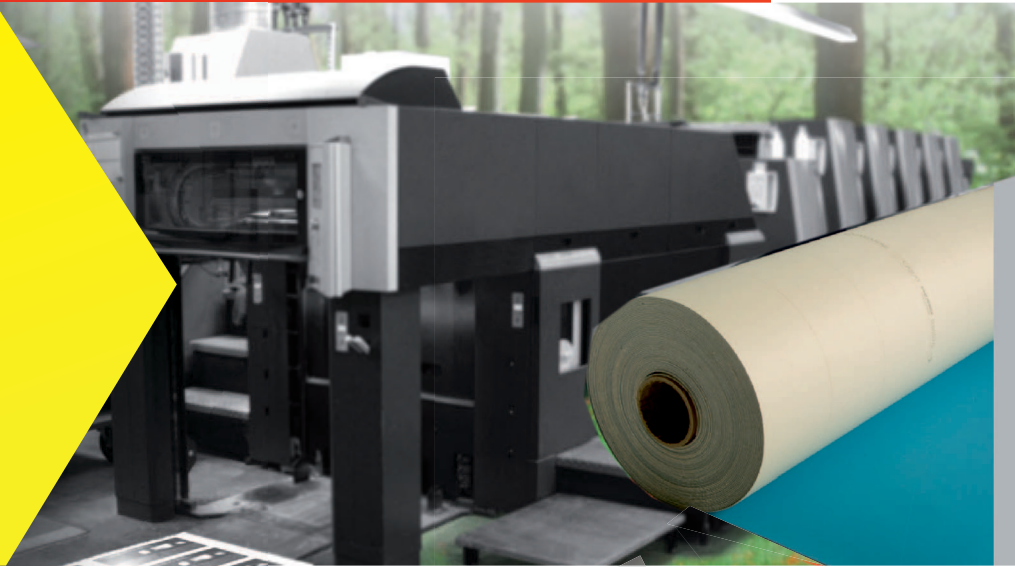

## Aquamarine+



Our improved specialist for packaging and metal printing

## Stratos



Our highly compressible all-round blanket solution for conventional sheet-fed printing

## Ruby CARAT



The no. 1 in UV offset printing

## Topaz CARAT



Suitable for hybrid applications and switching between UV & conventional inks / Combi

## Nova Spot



Our compressible varnishing plate for UV and waterbased coating (4 in 1)

## Amaranth *high speed*



Amaranth high speed is the innovative



# PHOENIX *Xtra* BLANKETS



*Your needs first. people and environment*

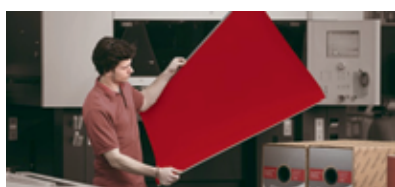
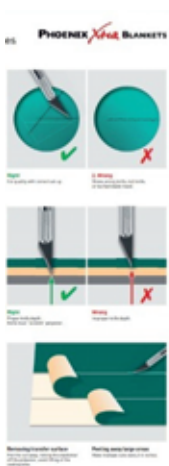



# RUBBER BLANKETS



- Polset**:- General purpose sheet fed blankets
- Ultra Green**:- General purpose sheet fed blankets
- Rapid**:- Versatile & Durable Web Blankets suits for all machines
- Print UV**:- Specially designed new generation EPDM face compound suitable for high quality UV Printing
- Royal Green**:- Premium Blankets for High Quality printing for all sheetfed applications
- StripCoat**:- Fabric reinforced coating Blankets for Strippable blankets for Coating and Varnishing applications

## Rubber Blankets

with Bar or without Bar Available  
 Heidelberg  
 Planeta  
 Komori  
 Mitsubishi  
 Akiyama  
 Roland  
 Crabtree  
 KBA  
 Dominant  
 Shinohara  
 Orient/ Excel  
 Goss Universal  
 Manugraphic CITILINE/HILINE  
 HAMADA  
 TOSHIBA  
 MILLER

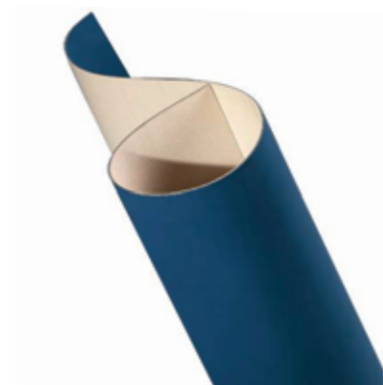



# RUBBER BLANKETS

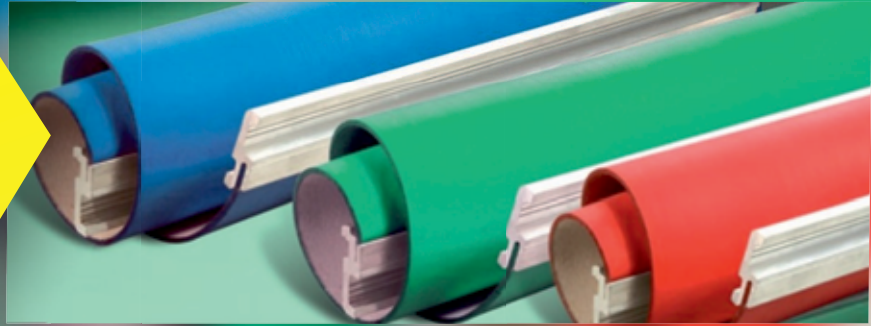

We are specialized in

- 1) Flat Bar
- 2) Steel Bar
- 3) Self Adhesive Blanket
- 4) UV Blankets
- 5) Coating Blankets
- 6) Varnish Blankets
- 7) Combi Blankets

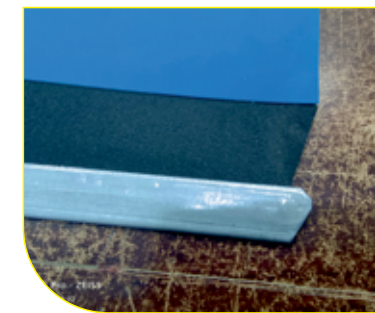
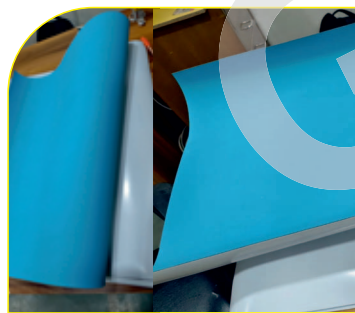
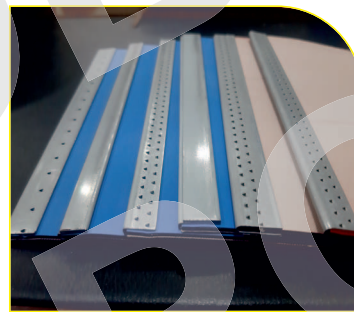
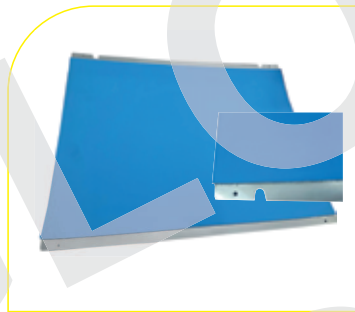
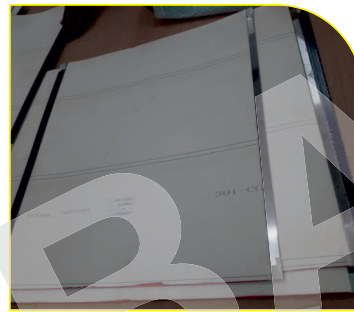
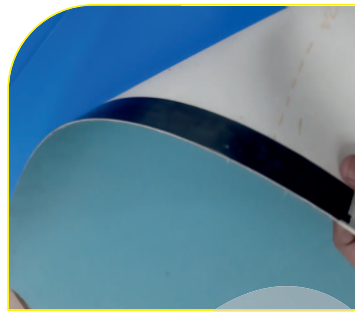



# Tailor Made BAR BLANKET



## Aluminium Steel- Flat Bar

- 1) Heidelberg Sm-74/Cd-102
- 2) Komori LS-429/GL-37/L440
- 3) Ryobi machine
- 4) Akiyama
- 5) Roland
- 6) Mitsubishi
- 7) GOSS
- 8) Orient
- 9) Manugraphic
- 10) Harris

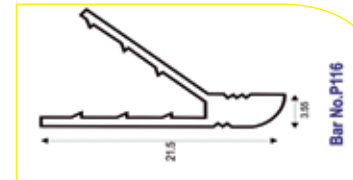
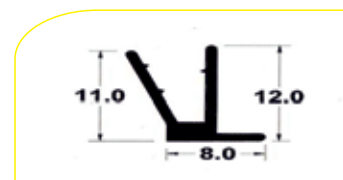
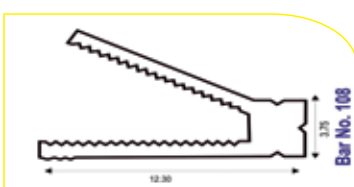
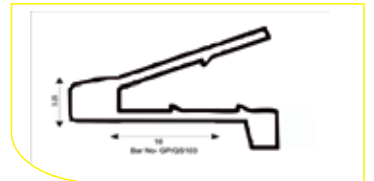
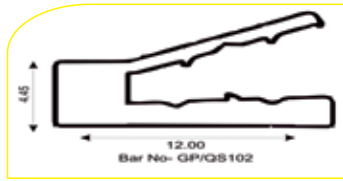
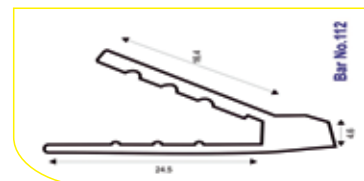
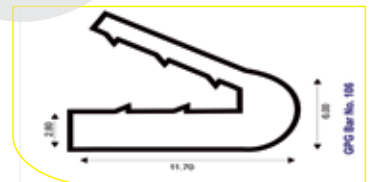
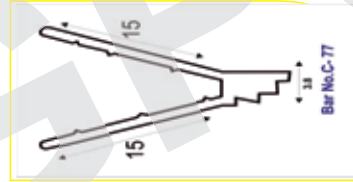
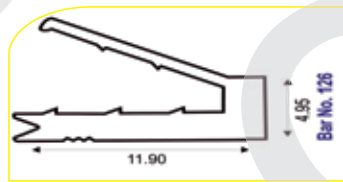



# Komori Machine Spare Parts



**KOMORI Spare Parts for**

- Feeder Unit
- Printing Unit
- Coating Unit
- Delivery Unit

- KOMORI Sprint GS 228
- SPICA 426
- Komori L 426
- LITHRONE LS/GL37
- LITHRONE LS/GL29
- LITHRONE LS40/GL40
- LITHRONE G40



Feeder Blast foot/ Metal



Delivery Chain link/RS60  
Tsubaki- Japan



Dial Gauge ( 0.4 - 6.00)



Rear Sucker/Feeder



Feeder Wheel Assly  
6mm x 45mm

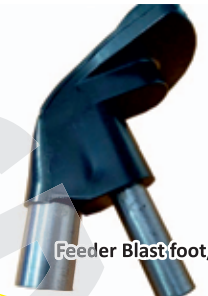

Feeder Blast/foot/Plastic



Forwarding sucker  
(Wire Type) - Black  
Feeder LS 529



Forwarding sucker  
(Manul/Knob Type)  
Feeder



Forwarding sucker assly  
(Fix Type) Feeder



Piston Forwarding sucker  
assly ( Feeder)



Lifting Sucker  
Feeder ( OD-20 \*ID-16\*L-36)



Lifting Sucker  
Feeder ( OD-22 \*ID-18\*L-52)



Fording sucker Wire type  
Steel feeder



Brush wheel- soft  
45mm \*6mm( Feeder)



Brush wheel- Hard  
45mm \*6mm( Feeder)



Feeder Wheel Assly  
6mm \*35mm



Feeder Brush wheel Assly



Runner- Rubber with Bearing  
OD 57mm ID 12mm Thickness 16mm



Belt runner / Plastic  
Feeder



Runner- Rubber with Bearing  
OD 35mm ID 6mm Thickness 14mm



Runner- Plastic  
OD 37mm ID 6mm Thickness 14mm



Runner Nylon with bearing  
OD-35 \* Thickness 14\*ID-6mm

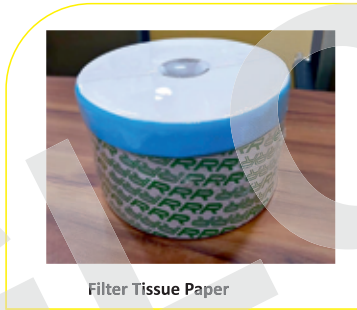

Filter Tissue Paper



Runner with bearing  
OD-47 \* 15mm \* thickness 15mm



Dial Gauge Cover  
Push type



Runner- Plastic  
OD 45mm ID 6mm Thickness 14mm



Komori Runner/Feeder

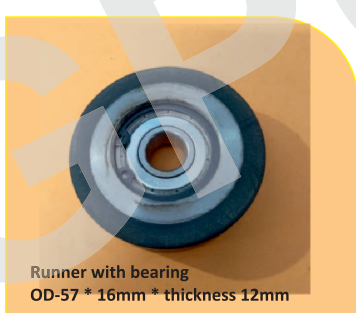

Runner with bearing  
OD-57 \* 16mm \* thickness 12mm



Filter- komori  
OD 98 \* ID -60 \* L 75mm



Filter- komori  
OD 70 \* ID -38 \* L 80mm



Filter for Blower Pump



Front lay Guide/GL40  
Smoother/feeder



Front lay Guide/LS40  
Smoother/feeder (3 type)



TRESU End Seal



Komori Coating Unit  
L52, W20, H15



Komori Fan

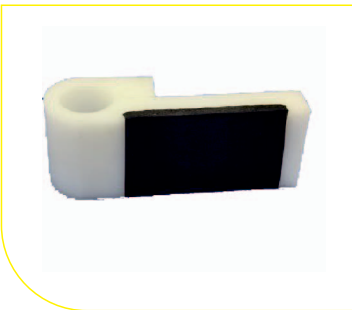

Powder Spray cup/ small size



Powder Spray cup/ Big size



AIR Cylinder / Piston  
DA 50\*50-8D



Oil Filter Big & Small Size



Damping roller Gear  
40 Teeth Gear



Damping roller Gear  
38 Teeth Gear



Damping roller Gear  
35 Teeth Gear



34 Teeth Gear



Damping roller Gear  
36 Teeth Gear



Damping Roller Gear / 31 Teeth



Damping Roller Gear / 32 Teeth



Damping roller Gear  
34 Teeth Gear



37 Teeth Gear



31 Teeth Gear



31 Teeth Gear



Tommy 8mm



Paper Separator Blower Plastic/Feeder

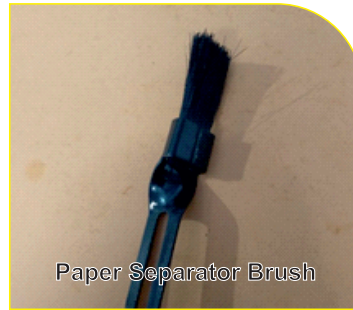

Paper Separator Brush

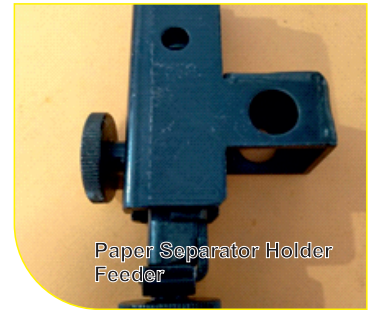

Paper Separator Holder Feeder



Rear Sucker Feeder



Diaphragm



Diaphragm Coated Pump



Diaphragm Coated Pump



Hickey remover



Wash up Blade LS-410



Wash up Blade LS-440



Wash up Blade LS/GL-37



Sucker



Nylon Rubber suckers  
32\*15\*.08mm  
35\*15.1mm



Ballom Type Sucker



CAP Type Sucker

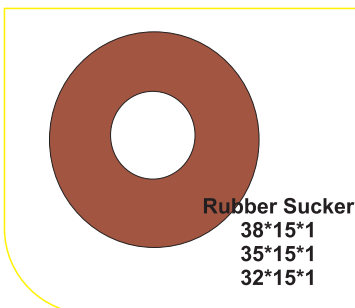

Rubber Sucker  
38\*15\*1  
35\*15\*1  
32\*15\*1

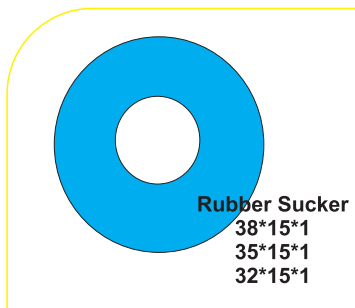

Rubber Sucker  
38\*15\*1  
35\*15\*1  
32\*15\*1

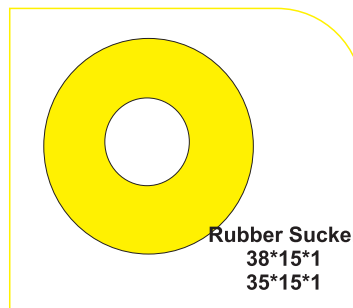

Rubber Sucker  
38\*15\*1  
35\*15\*1

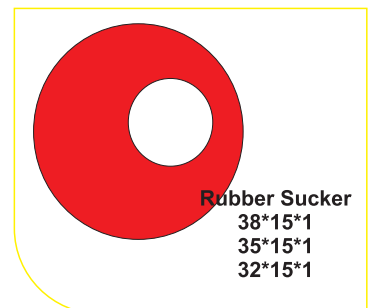

Rubber Sucker  
38\*15\*1  
35\*15\*1  
32\*15\*1



# Heidelberg Spare Parts

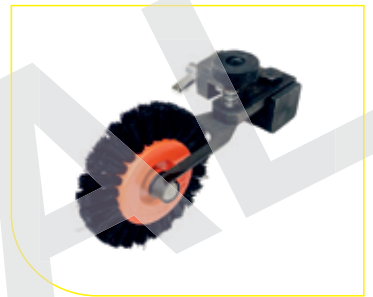
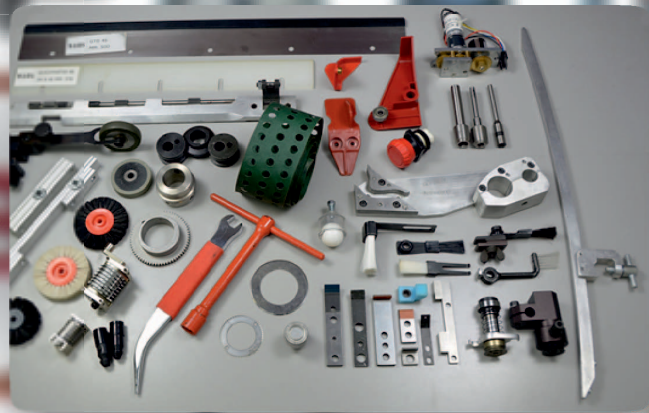

Ink Duct Foil



Anti marking Jacket



Protective Underlay Foil

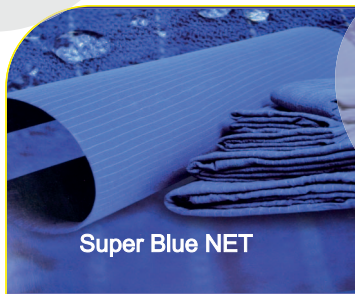

Super Blue NET

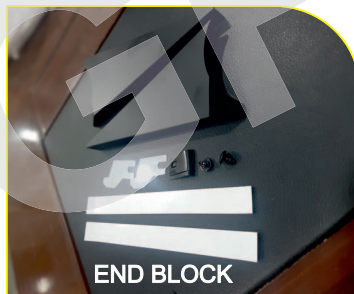

END BLOCK



Duck Insulation strips



Antimarking Jacket SM-102



Antimarking Jacket SM-102



Antimarking Jacket SM-74



Antimarking Jacket GTO52

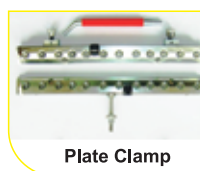
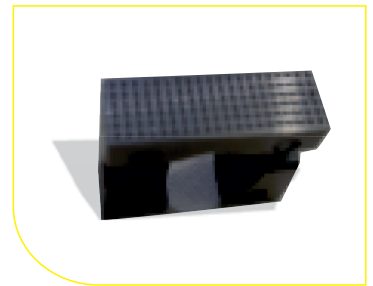
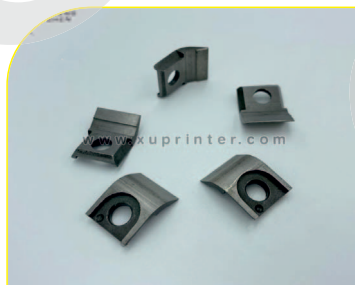
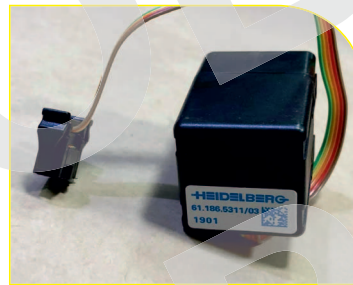
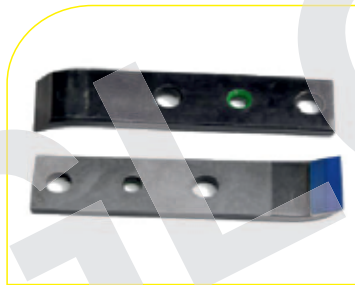
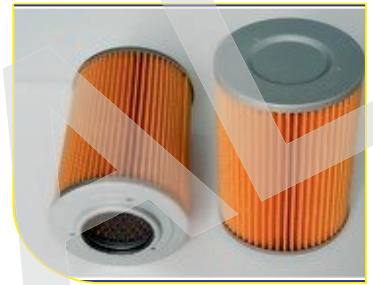
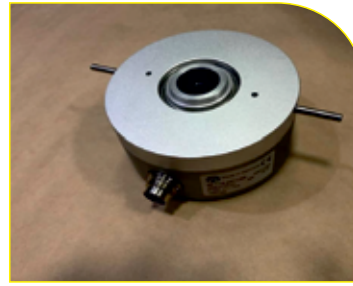

Plate Clamp



GTO-52 Plate Clamp





# KODAK MACHINES & SPARE PARTS CONSUMABLES

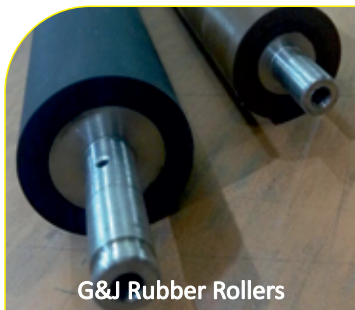

G&J Rubber Rollers



KODAK Rubber Rollers

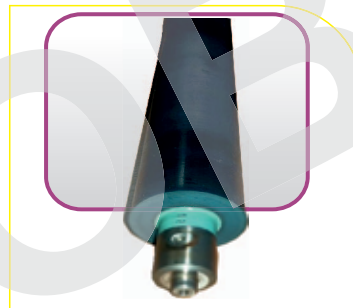

UDRC Drum Filter



Screen Air Filter

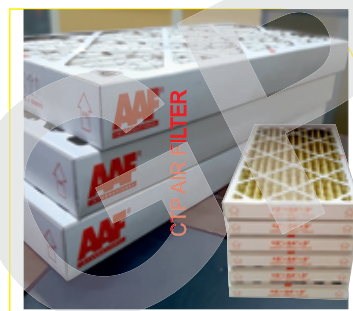

Coolent



Iwaki Pump MD-15 & MD20



Blower Motor



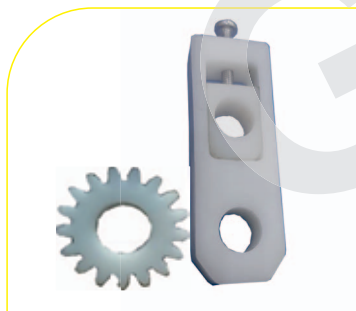
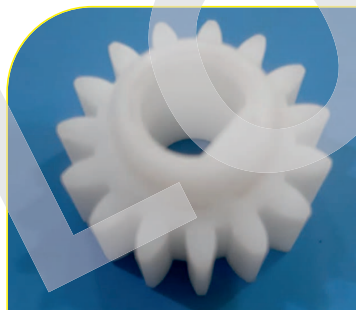
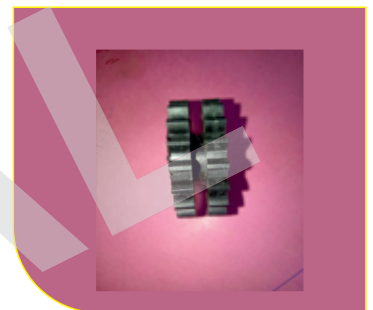
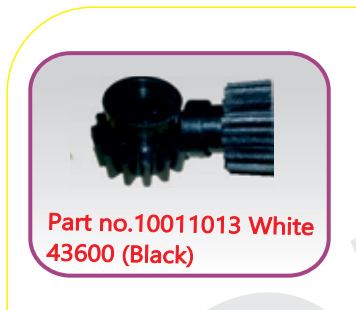

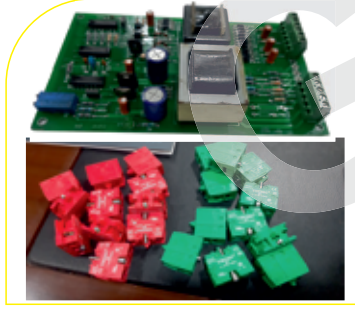
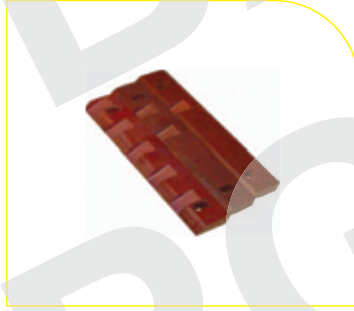
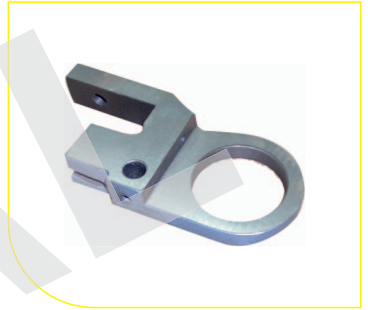
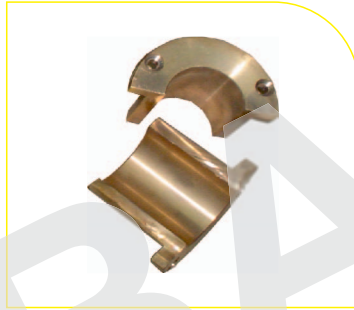
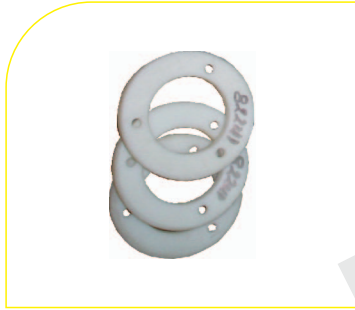



# Web Offset MACHINE SPARE PARTS



ORIENT SUPER,  
STANDARD, EXCEL  
FAST 200 & 300,  
NEWSLINE 30 & 45  
HILINE, STARLINE,  
MITSUBISHI  
HARRIS  
KOMORI  
GOSS  
WEBKING

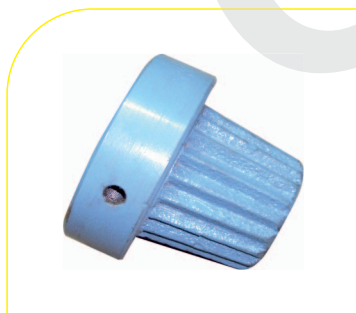
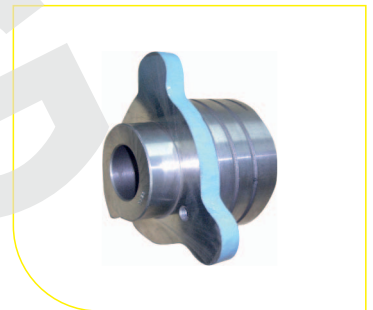





# SLOWDOWN BELTS

## SLOW DOWN BELTS

Manufactured to OEM Specifications



**HEIDELBERG,  
KOMORI, KBA &  
MITSUBISHI  
MACHINES**



Komori Slow Down Belt

26 holes cut grooves  
210mm X 14mm X 7mm raised



Heidelberg Slow Down Belt



Komori grey brake tape  
35 holes 210 x 14 mm



CD 102 XL Belt  
2015mm

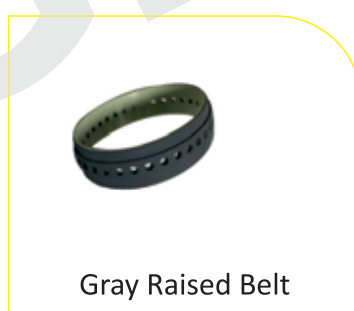

Gray Raised Belt



Green Flat Belt



Slow Down 20 Hole Belt  
220X38mm



Slow Down Belt Pink Raised



Yellow Flat

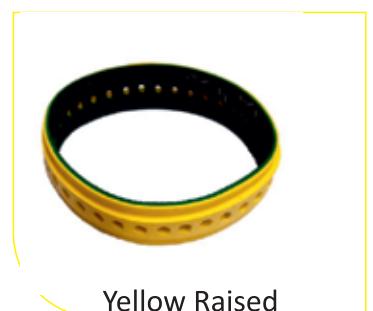

Yellow Raised



# PAPER CUTTING KNIFE - MATRIX / ATLAS

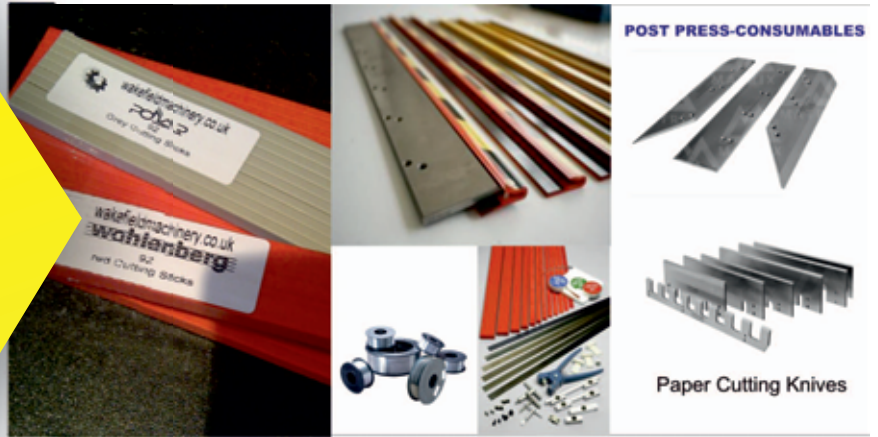

## Heavy Duty Cladded Steel & Platina XHD

- PERFECTA/SEYPA-92**  
Size:- 1090\*140\*12MM( 21 Hols M12\*1.5)
- PERFECTA/SEYPA-115**  
Size:- 1350\*140\*12MM( 30 Hols M12\*1.5)
- PERFECTA/SEYPA-132**  
Size:- 1515\*140\*12MM( 21 Hols M12\*1.5)
- POLAR-92**  
Size:- 1095\*115\*11.7MM( 11 Hols M10)
- POLAR-115/HPM-115**  
Size:-1390\*160\*13.75MM( 26Hols M12)
- POLAR-137**  
Size:- 1605\*160\*13.75MM( 30 Hols M12)
- SENATOR-92**  
Size:- 1090\*132\*9.95mm( 27 Hols M10)
- SENATOR-115**  
Size:- 1350\*144\*9.95mm( 36 Hols M12)
- WHOLENBERG-92**  
Size:- 1090\*120\*12mm ( 22 Hols M 12)
- WHOLENBERG-115**  
Size:- 1380\*125\*12mm ( 14 Hols M 12)

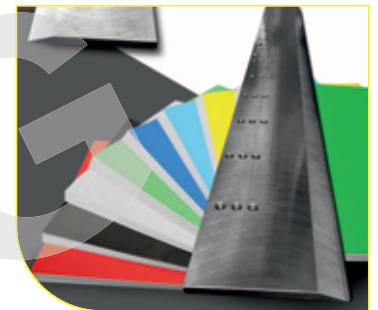
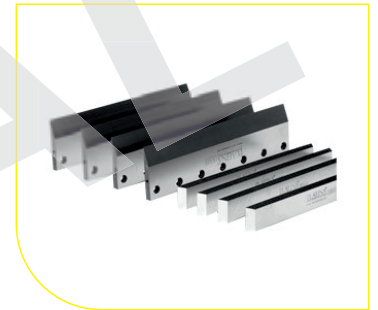

## Three Knief Trimmer

- KOLBUS- HD-49/HD100
- PERFECTA- ADF-25/35
- PERFECTA- D-30/42
- PERFECTA- SDY-2
- WHOLENBERG A-43/44F
- TRIDENT E-15
- MULLER MARTINI- 3670/3672 NEW
- MULLER MARTINI- 3671 - series-97
- MULLER MARTINI- 3672
- MULLER MARTINI- 1509/1522
- MULLER MARTINI-360(Prime)
- FLOW LINE set for Star stich m/c.
- BREHMER/STAHL ST300(Saddle Stitch)

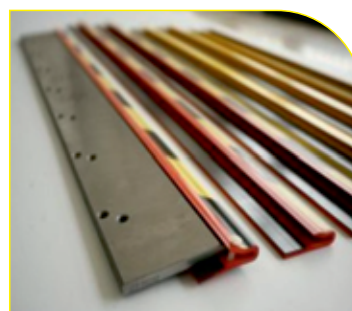
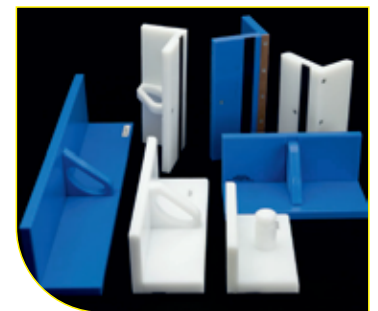
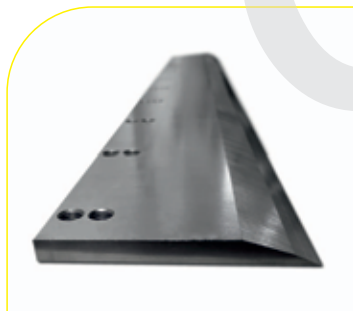



# Creasing MATRIX ACCESSORIES

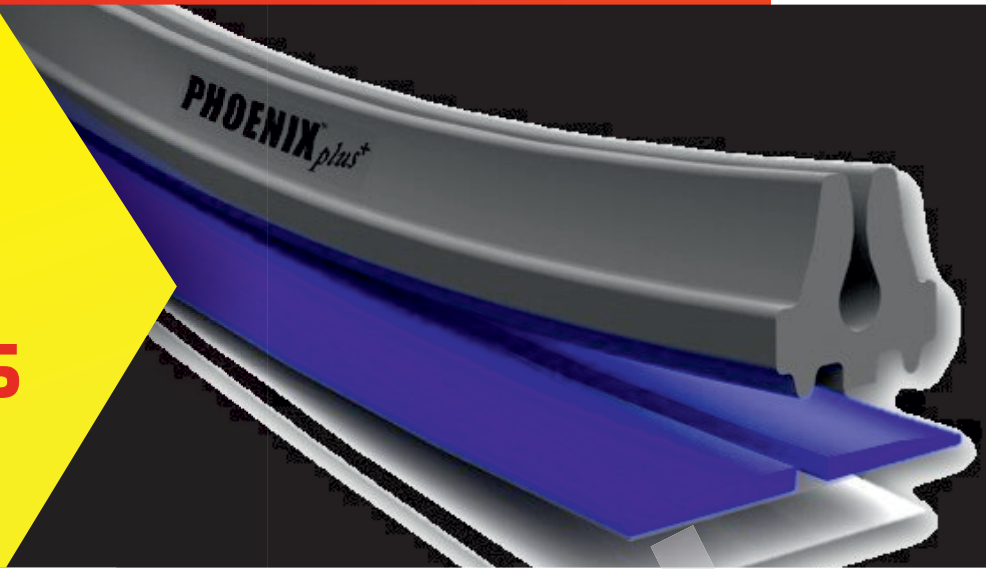

## Creasing Matrix Dimension

150-250 gr	300 gr	350 gr	400 gr	Cardboard	Corrugated cardboard
0,3x0,8	0,4x0,8	0,5x1,3	0,6x1,7	0,8x2,5	1,0x3,0
0,3x1,0	0,4x1,0	0,5x1,5	0,6x1,9	0,8x2,8	1,0x4,0
0,3x1,3	0,4x1,3	0,5x1,7	0,6x2,2	0,8x3,0	1,0x5,0
0,3x1,5	0,4x1,5	0,5x1,9	0,6x2,5	0,8x3,2	
	0,4x1,7	0,5x2,5	0,6x2,8	0,8x3,5	
	0,4x1,9	0,5x2,8	0,6x3,2		

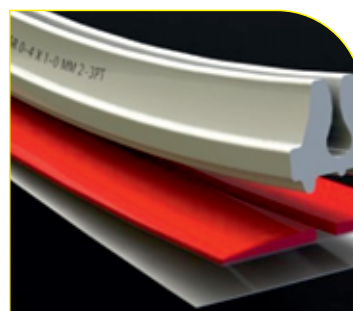
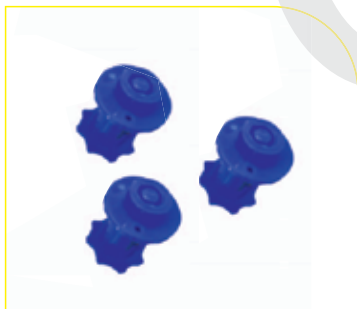
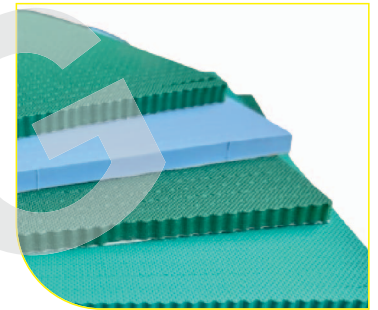



# Doctors Blades



# TRESU



Harris & Bruno Doctors Blade



Anilox Clearing Brush

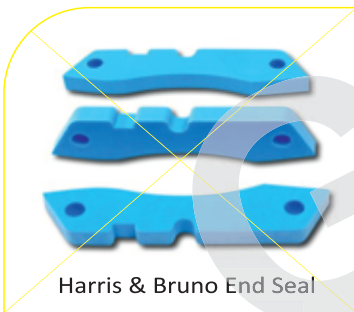

Harris & Bruno End Seal

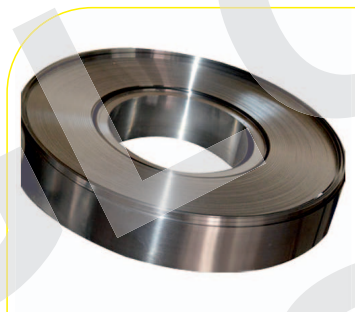

Tresu End Seal



Harris & Bruno Doctors Blade  
32mm x 0.18mm x 100Ft (30m)



# TRESU





# Chilling Unit Filters

## Recirculation Chiller Filter

- Technotrans
- Royce
- Baldwin
- Aquapress
- MG Electric
- Roland
- KBA
- Komori
- Planeta
- Mitsubishi
- Etc..

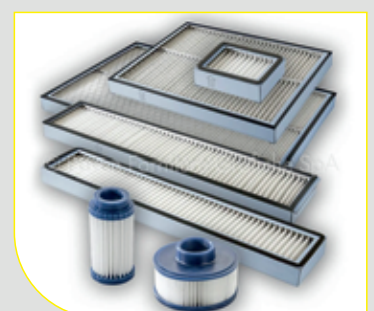
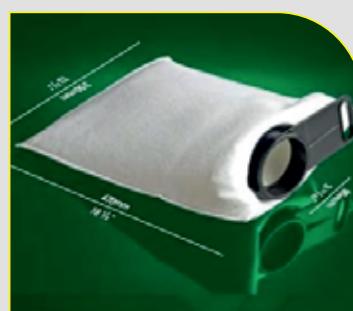
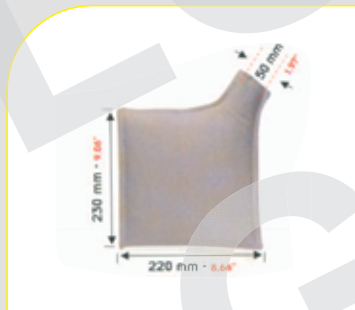
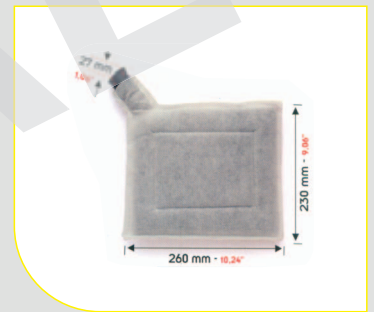
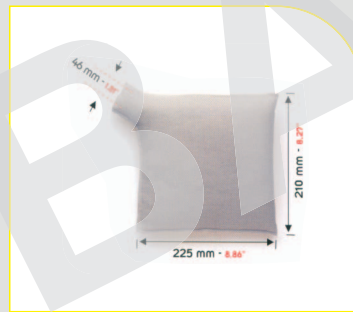



# Manila Art Paper

DISPONIBILI THICKNESSES AVAILABLE ESPESORES DISPONIBLES		
mm	my	inch
0,05	80	002"
0,075	75	003"
0,10	160	004"
0,125	125	005"
0,15	150	006"
0,175	175	007"
0,20	200	008"
0,25	250	010"
0,30	300	012"
0,40	400	016"
0,50	500	020"

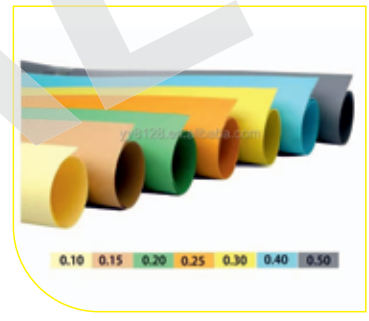

# ANTI MARKING FILM



Established in 1983, Policrom, Inc. is part of a worldwide organization providing graphic art and pressroom supplies such as layout and proofing materials, ink fountain liners, press packing and washcloth used in offset and web printing.



## Self Adhesive Polyesters Film



### POLIPACK-AA

Available in sheet & Roll

- 100 MICRON
- 120 MICRON
- 140 MICRON
- 200 MICRON
- 230 MICRON
- 250 MICRON
- 300 MICRON
- 350 MICRON
- 400 MICRON
- 450 MICRON
- 500 MICRON



# BLANKET UNDER PACKAGING

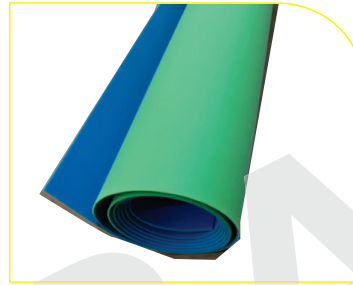

# BOTTCHER ROL-O-PAST



Fountain Solution S-3007 / Böttcher IPA Special \ Böttcher IPA / Böttcher 60 Conventional Auto Wash / Böttcher UV Wash / Böttcher Aquasol

Böttcher FR 1000 / Böttcher Cleanfix UV(500gm) / Böttcher Cleanfix pro(500gm) / Böttcher Calcium fix (500gm) / Feboclean RE(700gm) / Roll o Gel (700gm) / Roll o Paste (700gm)



# BOBST MACHINE Spare Parts

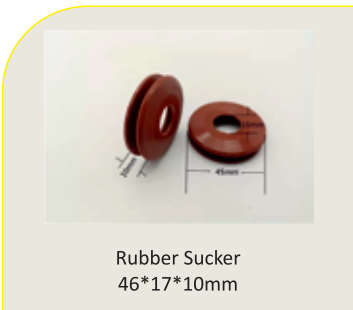

Rubber Sucker  
46\*17\*10mm



Runner SP-102 E



MOST SOLD SP-102E



Brush wheel Bobst machine



spring paper separator



Brush wheel Bobst machine

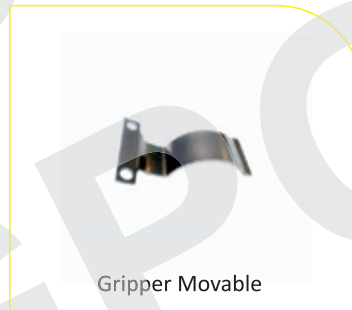

Gripper Movable



Lifter



suction cup



Universal Brush for  
all Bobst machine



Feeder Brushwith  
Polyamide Bristles



Feeder Brushwith  
Polyamide Bristles



Brushes feeder





# WASHUP BLADE FOR INK ROLLER

(HEIDELBERG & KOMORI)

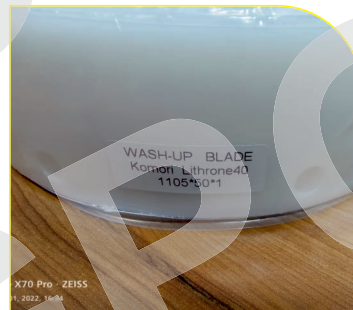
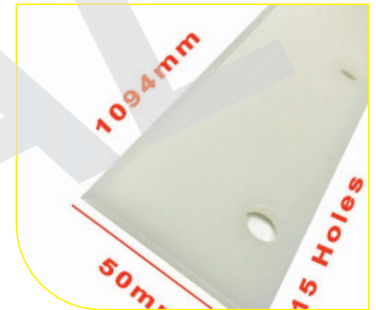
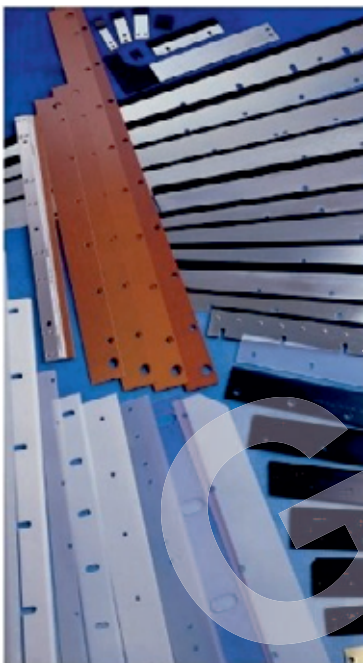

X70 Pro - ZEISS  
11.2022.1024

X70 Pro - ZEISS  
11.2022.1048

Pro - ZEISS  
11.2022.1024

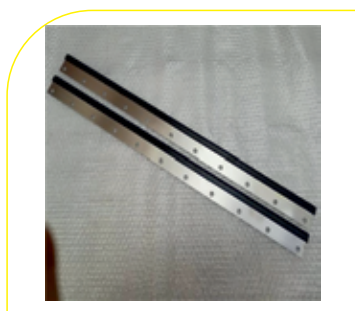

## WASH-UP BLADES

HEIDELBERG					MM						
MODEL	TYPE	LENGHT	WIDTH	THK	NO HOLES	MODEL	TYPE	LENGHT	WIDTH	THK	NO HOLES
GTO S2/PM S2	M	560	60	0.5	6	SPRINT 715	M	715	50	0.5	6
MO	M	710	60	0.5	8	LITHRON 26	M	726	42	0.5	6
SM 52	M	665	46	0.5	7	LITHRON LS 26	M	730	35	0.5	10
SM 72	M	790	60	0.5	11	LITHRON 28	M	765	47	0.5	11
PM 74	M	822	57	0.5	9	LITHRON 28	M	765	47	1	11
SM 74	M	822	57	0.5	9	LITHRON 32	M	892	47	5	12
CD 74	M	847	47	0.5	9	LITHRON 32	M	892	43	0.5	6
SM / CD 102	M	1090	60	0.5	11						
XL 105	M	1125	41	0.5	21						
SOR	M	890	60	0.5	9						
SORR	M	710	60	0.5	8						
SORR / Z	M	790	60	0.5	11						
SORR2	M	960	60	0.5	11						
SORS	M	1090	60	0.5	11						
KORL	M	660	50	2	10						
KORA	M	622	50	2	10						
KORD 62	M	650	50	2	10						
KORD 64	M	690	50	2	12						
KORIS	M	760	50	2	12						

KOMORI					MM						
MODEL	TYPE	LENGHT	WIDTH	THK	NO HOLES	MODEL	TYPE	LENGHT	WIDTH	THK	NO HOLES
LITHRON 32	M	892	43	0.5	6	LITHRON 32	M	892	43	0.5	6
LITHRON 40	P	1067	47	5	15	LITHRON 40	P	1067	47	5	15
LITHRON 40	M	1067	47	0.5	15	LITHRON 40	M	1077	47	0.5	15
LITHRON 40	M	1077	47	0.5	15	LITHRON 40	M	1090	43	0.5	15
LITHRON 40	M	1090	43	0.5	15	LITHRON 40	M	1094	50	5	15
LITHRON 40	M	1094	50	5	15	LITHRON 40	M	1105	50	0.5	15
LITHRON 40	P	1100	47	5	0	LITHRON 40	P	1100	47	5	0

HEIDELBERG					MM						
MODEL	TYPE	LENGHT	WIDTH	THK	NO HOLES	MODEL	TYPE	LENGHT	WIDTH	THK	NO HOLES
1F	M	776	20	3	9	1F	M	776	20	3	9
1F / F	M	776	33	0.5	9	1F / F	M	776	33	0.5	9
2F	M	884	40	0.5	9	2F	M	884	40	0.5	9
DIAMOND 2000	M	877	33	2	10	DIAMOND 2000	M	877	33	2	10
3F	M	1080	43	5	11	3F	M	1080	43	5	11
3F	M	1080	35	2	11	3F	M	1080	35	2	11
3F	M	1090	45	0.5	11	3F	M	1090	45	0.5	11
3F/DIAMOND	M	1080	35	0.5	11	3F/DIAMOND	M	1080	35	0.5	11
3F/3C DIAMOND 3000	M	1095	40	0.5	11	3F/3C DIAMOND 3000	M	1095	40	0.5	11
3F/3F DIAMOND 3000	M	1100	40	0.5	11	3F/3F DIAMOND 3000	M	1100	40	0.5	11
3D	M	1110	45	0.5	11	3D	M	1110	45	0.5	11
4E	M	1190	47	0.5	10	4E	M	1190	47	0.5	10
5F	M	1348	45	0.5	19	5F	M	1348	45	0.5	19
WEB PRESS L750	M	1050	50	0.5	11	WEB PRESS L750	M	1050	50	0.5	11
WEB PRESS	M	1524	60	0.5	16	WEB PRESS	M	1524	60	0.5	16

LEGEND:  
M = METAL WITH RUBBER, P=PLASTIC,  
E=EPDM, T=TEFLON



# HAND STRIPPING MACHINE



Pneumatic cardboard carton box Waste Stripping Machine  
 Waste Stripper remover  
 Cardboard Trimming  
 Tools Paper Edge Cutting  
 Tool Machine  
 (Single/ Double Claw Chian)

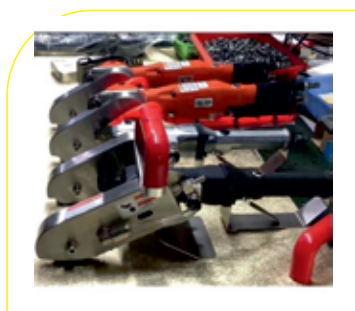



# Falcon Press-room Chemicals

Made in India with Ireland Technology

Technical know how from *Intec Chemform Limited, Ireland*

"Manufactured in India  
under Technical know how  
from.  
**INTEC CHEMFORM LIMITED,  
IRELAND**

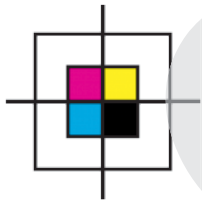

Sheet Fed Fount  
Web offset Fount  
IPA replacement  
Plate Care Products  
Blanket & Roller Washes  
Anitset off Powder





# PLATE SUCKERS



## Plate Sucker

Silicon /Normal  
Standard/ UltraThin/Super Thin  
Komori  
Heidelberg  
KBA  
Roland

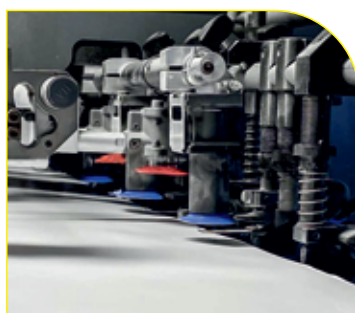
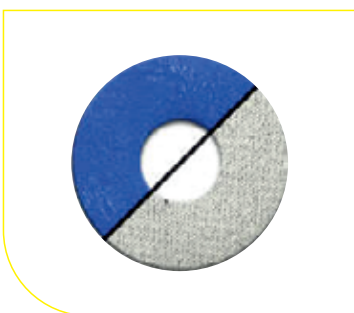
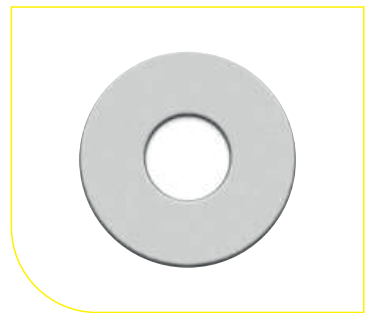
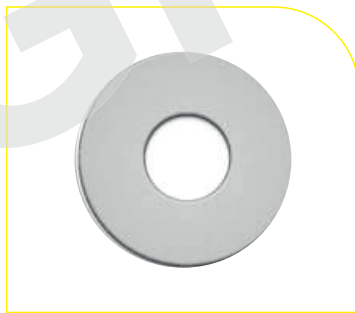
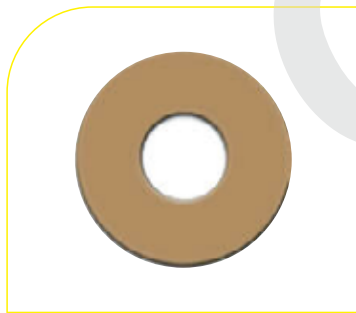
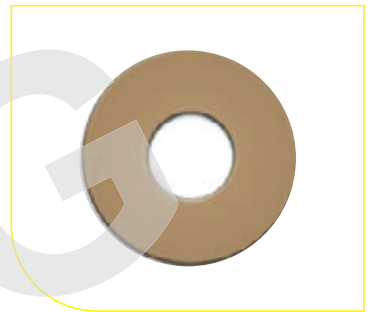
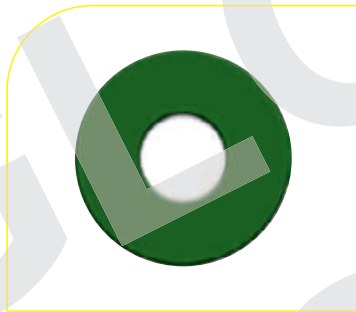
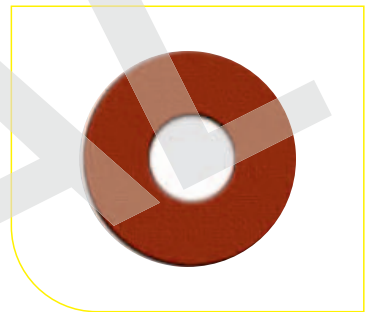
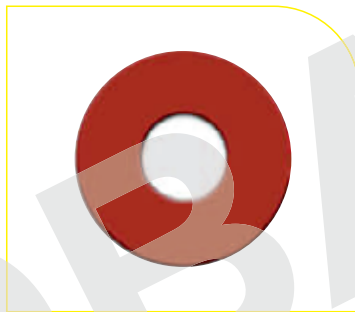
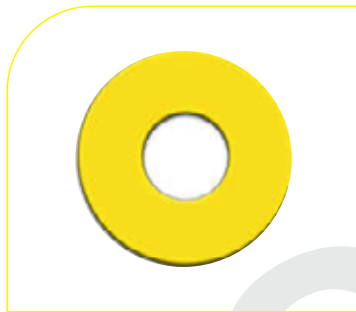



# VISKOVITA Sponzes

**VISKOVITA®**



**VISKOVITA  
Sponzes**





# DRILL BITS



**Brand/Make-ERB**

**Usage/Application  
Printing Industry**

**Hole Diameter  
2-12 mm**

**Total Length  
57-100mm**

**Shank Dia  
11 mm**

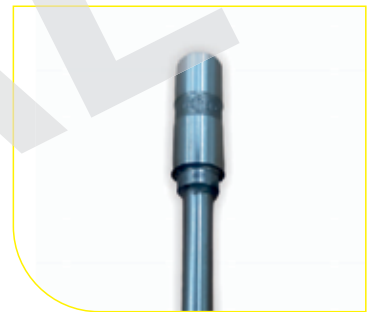
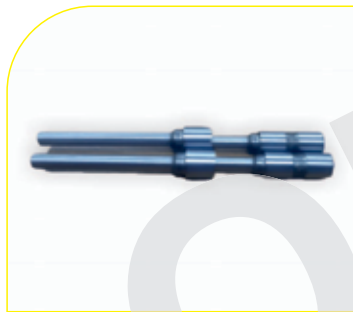

**PAPER DRILL BITS**

E.R.B. High Duty Hollow Paper Drill Bits are known worldwide and guarantee absolutely perfect holes and are suitable for highest speeds. Because of the perfect concentric drilling they ensure easy emptying. They are produced of a high quality tool steel which guarantees a long tool life and a high edge retention.

E.R.B. Paper Drill Bits are available from 2,0 – 60,0 mm cutting diameter and can be operated in any drilling machine anywhere around the world. We can offer any type imaginable





# PH METER



pH and conductivity testers that fit in your pocket. Take accurate and reliable measurements with our portable testers that go where you go.

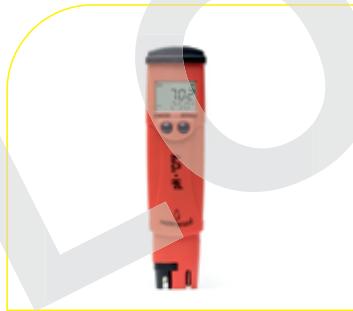

# EYE GLASSES

20X Metal Eye glass with LED



6X Paper Weight eye glass →



10X EYE GLASS

Amplification effect



15 X Luna Eye Glass

