

BLIZZ[®]

INFRARED SAUNA

The only Sauna Expert of India



IS: 302 : PART 1 : 2024



LN. : 7200314699

BLIZZ INFRARED SAUNA
Relax - Rejuvenate – Refresh

www.infraredindia.com

BLIZZ[®] has built a strong reputation over the past 15 years as a leading Infrared Sauna Manufacturer in India. With a dedication to innovation and the latest advancements in wellness equipments BLIZZ[®] stands out in the market. Our line of Far-infrared saunas caters to diverse preferences and budgets, from portable models to deluxe custom-made options with exclusive features. With over 4500 units installed across India, BLIZZ[®] has established itself as a leader in the infrared sauna market.

What are Infrared Waves/Rays?

Infrared waves, or infrared light, are part of the electromagnetic spectrum. People encounter Infrared waves every day; the human eye cannot see it, but humans can detect it as heat.

It's inside us!

Far Infrared Ray (EIR) is the 'warm' energy in humans, animals and plants, emitted from sunlight. The intensity of FIR heat produced for humans consciously fluctuates. When it is high, we feel healthy and when it is low we feel unwell. FIR is completely healthy and safe for all living things.

How it works

Far Infrared therapy very gently increases blood flow by expanding the capillaries that carry blood. It also increases oxygenation and regeneration of the blood, deeply detoxifying it for the improved functioning of all of the major organs in the body, which depend on blood for energy. This detoxification is on the deepest level, allowing hidden toxins in the blood and tissue to be dissolved or immobilized.

The Science behind Infrared & how it boots our inner system

Infrared sauna therapy stimulates mitochondria to increase ATP production, regulate blood sugar, and improve circulation by promoting nitric oxide production, which dilates arteries and lowers blood pressure. It boosts immunity by mimicking a fever, increasing white blood cells, and fighting pathogens, while oxygen-rich blood reduces inflammation and pain. The therapy detoxifies organs, aiding conditions like autism and chronic pain, and effectively removes heavy metals from the body. It also burns 600-900 calories in 30 minutes, akin to cardio exercise. Additionally, it balances hormones by boosting melatonin and reducing cortisol levels, making it a safe, comprehensive health solution for daily use.

Full-spectrum full benefits

Blizz Infrared sauna is a full spectrum because of its unique patent properties in the sauna world. The infrared spectrum consists of near (NIR), mid (MIR), and far (FIR) infrared waves, each with distinct characteristics and frequency ranges. Longer wavelengths (or far infrared waves) are thermal, while short or near-infrared waves are not hot at all, in fact, you cannot even feel them.





Blizz Infrared Sauna has been 100% designed and manufactured in India in our own manufacturing unit. We are the only Custom IR Sauna manufacturer in India

Why Blizz?

- Highest Quality seasoned wood
- 360 Bio Ceramic coating
- World's best Far infrared emitters
- Advance Control System
- Red Light Therapy enabled
- Low or negligible EMF
- Low power consumption
- Right Temperature
- Easy Installation
- 24 X 7 After Sales Service

Versatile Application



Hospitals and Physiotherapist centers can improve their patient's conditions significantly, especially of those who are either - Diabetic, Obese, Cancer, Arthritis skin decease, etc.



Beauty saloons, Independent Spa, Hotels can use infrared sauna as it does not requires any water connection or boiler, and it's very easy to use and almost maintenance free!



Slimming centers & Gym can increase the results of their clients many folds, as in 30 minutes it can burn up to 900 calories which leads to weight loss every time one use!



Builders, Colonizers, Architects, Interior Designers, have a wonderful opportunity to present their customers a new and beneficial product which has strong potential to become a unique USP

Home Sauna

Club/Gym Sauna

Custom Sauna

Commercial Sauna

Sauna for Autism

Meso Therapy Dome

Reduce Medicines

for Diabetes, Blood Pressure, Arthritis, Thyroid, PCOD and Obesity

The Miracle of Far Infrared Therapy

Effective in Boosting the cure of many Diseases



Significant Reversal in Diseases

- Diabetes
- Hypertension (BP)
- Thyroid
- Acidity & Constipation
- Vitamin D3 Deficiency
- Gastritis & Acid Reflux
- Cholesterol
- Water Retention
- Uric Acid
- Low Metabolism
- PCOD

Significant Results in

- Heat Shock Protein
- Heavy Metal Detox
- Autism Spectrum
- Autoimmune Disorder
- Arthritis Relief
- Hormones & PCOD
- Supports Cancer Treatment
- Long COVID Recovery

Instant Pain Relief & Recovery

- Rheumatoid Arthritis
- Muscle Spasm
- Chronic Joints Pain
- Frozen Shoulder
- Sciatica & Numbness
- TMJ Arthritis
- Lower Back Pain
- Sports Injuries
- Fracture Healing

Functional Medicine Support

- Ozone Therapy + FIR
- IV Infusion Therapy + FIR
- Colon Hydro Therapy + FIR
- Chelation + FIR
- Hyperbaric Oxygen Therapy + FIR

Skin Disorder Recovery

- Psoriasis & Eczema
- Dandruff & Anti Ageing
- Acne & Clogged Pores
- Cellulitis

FIR Acts as a Body Charger

- Detoxification
- Kills Anxiety
- Distress & Relaxation
- De-Alcoholism
- Cancerous Toxin Elimination
- Corrects Sleep Disorder
- Recover Confidence
- Excellent Sex Life



30 minutes of session of Blizz Infrared Sauna is equivalent to 10 km of jogging

Fat to Fit Journey Starts

- Burns 600-900 Kcal
- Reduce Body Fat
- Cellulite Reduction
- Instant Inch Loss
- Weight Loss



Home/Clinic Sauna

(4 x 4 feet)



This 4'x4' sauna is an ideal choice for families and small clinics or physiotherapy centers, requiring just 36 square feet of space for installation within your home/clinic. Upon ordering, it arrives compactly packed; a service agent will handle assembly and installation as well as provide guidance on usage, do's, and don'ts. All it needs is a 15-amp switch and it is ready for use, offering a convenient and compact sauna experience for your entire family/customers.

MATERIAL & DESIGN:

- | Wood Type: American Pine with Wall Grainy Veneers (Outer Surface)
- | Inner Walls: Bio Ceramic Nano Particle Coated
- | Type: Free Standing Portable Sauna Cabin
- | Color: Pine Wood
- | Glass door with Frame

FEATURES & HIGHLIGHTS

- | Inbuilt Bluetooth Music System
- | Red Light Therapy Lights
- | Portable and Easy to Install
- | Designed and Made for Indian Conditions
- | 360° Far Infra-Red Emission for Uniform Heating
- | More Effective and Efficient than Imported Saunas
- | UV Protective, Zero EMF, and Negative Ion Generation
- | All-India Service and Installation Available
- | Customization Available in All Sizes and Features

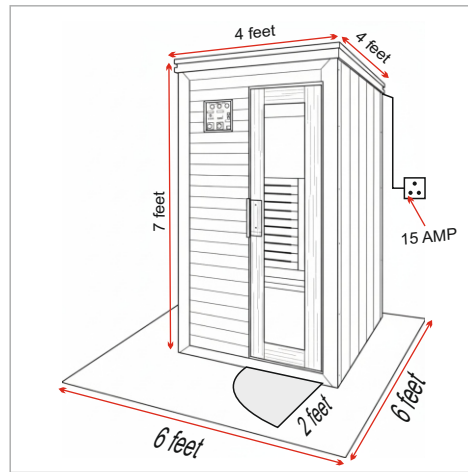
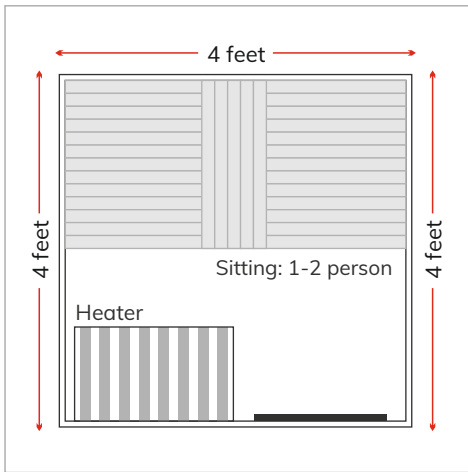
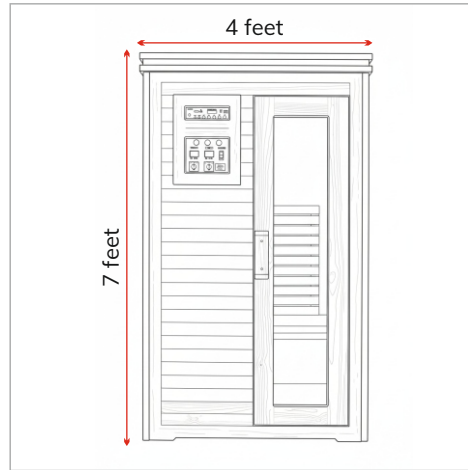

Technical Specifications



Dimensions:
4 x 4 x 7 feet
1220 x 1220
x 2135 mm



Area Required:
6x6 Sq. Feet
(36 Sq. Feet)



Electrical Power:
2000 Watts, 230V
15 AMP Plug Point
(Single Phase)



Temperature Range:
65°C to 70°C



Infrared Type:
360° For Infrared
Emission



Heating System:
Concave Ceramic
Heaters
(Made in Germany)



Wavelength:
Full Spectrum
(2 to 10 microns /
2000-10000 nm)



Infrared Source Life:
Approx. 10,000
working hours



Average Warm-Up Time:
30-40 minutes



Control:
Outside manual
control panel



Premium Star

(4 x 4 feet)

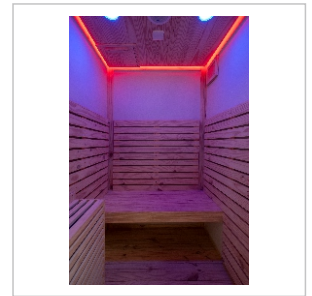

Premium Star is a true star that elevates your wellness space with its luxurious 4' x 4' Infrared Sauna. Fitting effortlessly into just 36 sq. ft., it offers a compact yet indulgent retreat for homes and clinics. Deep far-infrared warmth melts stress, soothes muscles, boosts circulation, and supports daily detox. Red-light therapy lights, along with an inbuilt music system, enhance healing and ambiance. A sleek touch-screen control panel ensures effortless control, making every session pure luxury.

MATERIAL & DESIGN:

- | Wood Type: American Pine with Wall Grainy Veneers (Outer Surface)
- | Inner Walls: Bio Ceramic Nano Particle Coated
- | Type: Free Standing Portable Sauna Cabin
- | Front side covered with around 90% glass
- | Red lighting accent strip for soothing sauna environment
- | Color: Pine Wood
- | Ambient multi-colour LED lighting

FEATURES & HIGHLIGHTS

- | Inbuilt Bluetooth Music System
- | Red Light Therapy Lights
- | Portable and Easy to Install
- | Designed and Made for Indian Conditions
- | 360° Far Infra-Red Emission for Uniform Heating
- | More Effective and Efficient than Imported Saunas
- | UV Protective, Zero EMF, and Negative Ion Generation
- | All-India Service and Installation Available
- | Customization Available in All Sizes and Features

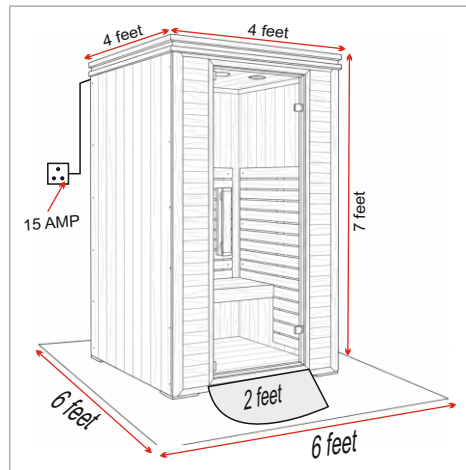
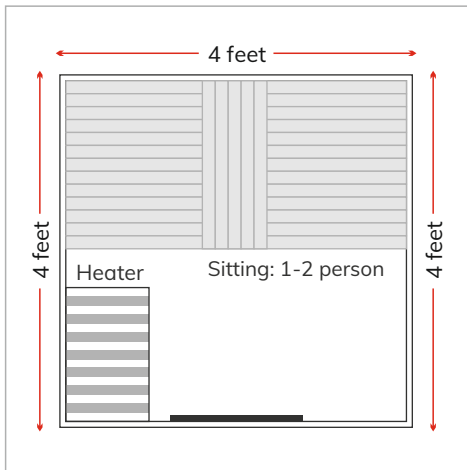
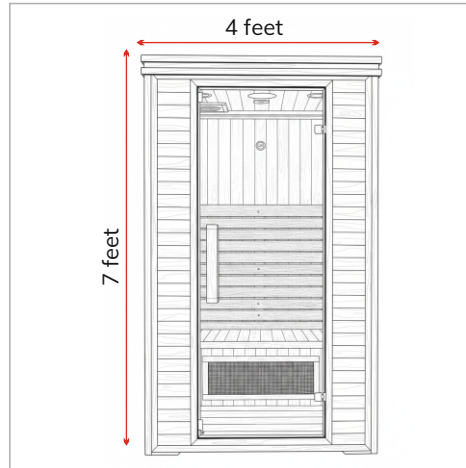

Technical Specifications



Dimensions:
4 x 4 x 7 feet
1220 x 1220
x 2135 mm



Area Required:
6x6 Sq. Feet
(36 Sq. Feet)



Electrical Power:
2000 Watts, 230V
15 AMP Plug Point
(Single Phase)



Temperature Range:
65°C to 75°C



Infrared Type:
360° For Infrared
Emission



Heating System:
Concave Ceramic
Heaters
(Made in Germany)



Wavelength:
Full Spectrum
(2 to 10 microns /
2000–10000 nm)



Infrared Source Life:
Approx. 10,000
working hours



Average Warm-Up Time:
30–40 minutes



Control:
inside Digital
Touch Display



Premium One

(4 x 4 feet)



PremiumOne brings luxury wellness within reach with its elegant 4' x 4' Infrared Sauna, designed for homes, clinics, and compact wellness spaces, fitting effortlessly into just 36 sq. ft. to create a soothing private retreat. An inbuilt music system adds a calming sensory ambiance, while its intuitive touch-screen control panel ensures effortless operation, making **PremiumOne** a seamlessly luxurious wellness ritual you'll look forward to every day.

MATERIAL & DESIGN:

- | Wood Type: American Pine with Wall Grainy Veneers (Outer Surface)
- | Inner Walls: Bio Ceramic Nano Particle Coated
- | Type: Free Standing Portable Sauna Cabin
- | Color: Pine Wood
- | Front side covered with around 70% glass

FEATURES & HIGHLIGHTS

- | Inbuilt Bluetooth Music System
- | Red Light Therapy Lights
- | Portable and Easy to Install
- | Designed and Made for Indian Conditions
- | 360° Far Infra-Red Emission for Uniform Heating
- | UV Protective, Zero EMF, and Negative Ion Generation
- | All-India Service and Installation Available
- | Customization Available in All Sizes and Features
- | More Effective and Efficient than Imported Saunas

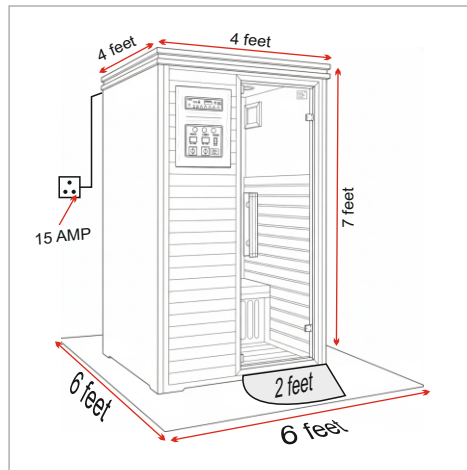
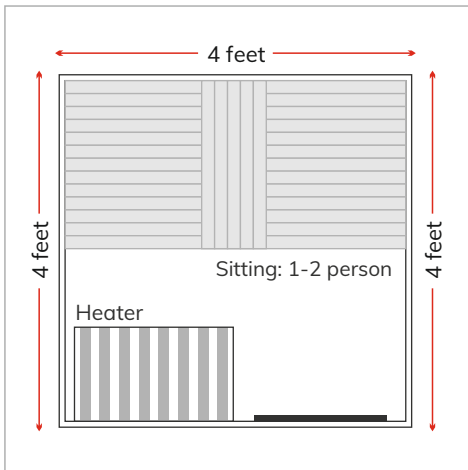
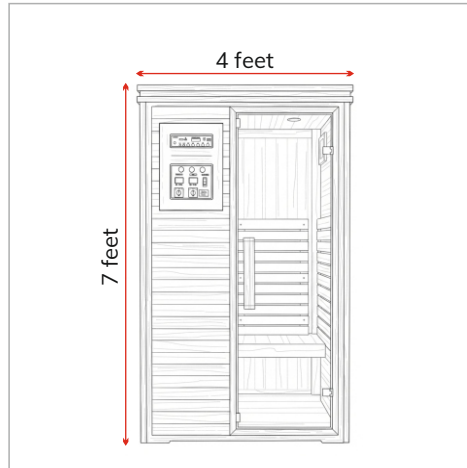

Technical Specifications



Dimensions:
4 x 4 x 7 feet
1220 x 1220
x 2135 mm



Area Required:
6x6 Sq. Feet
(36 Sq. Feet)



Electrical Power:
2000 Watts, 230V
15 AMP Plug Point
(Single Phase)



Temperature Range:
65°C to 70°C



Infrared Type:
360° For Infrared
Emission



Heating System:
Concave Ceramic
Heaters
(Made in Germany)



Wavelength:
Full Spectrum
(2 to 10 microns /
2000–10000 nm)



Infrared Source Life:
Approx. 10,000
working hours



Average Warm-Up Time:
30–40 minutes



Control:
Outside manual
control panel



Commercial Sauna

Centre door (6 x 4 feet)

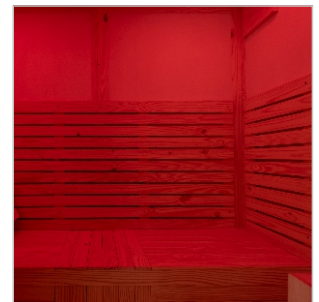

This versatile and heavy-duty sauna is available in 6'X4' size, though custom sizes are also available. The tough build makes it perfect for commercial usage. With a heavy-duty design, it requires low maintenance and is built to last, ensuring a long-term investment for your business.

MATERIAL & DESIGN:

- | Wood Type: American Pine with Wall Grainy Veneers (Outer Surface)
- | Inner Walls: Bio Ceramic Nano Particle Coated
- | Type: Free Standing Portable Sauna Cabin
- | Color: Pine Wood
- | Front side glass door

FEATURES & HIGHLIGHTS

- | Inbuilt Bluetooth Music System
- | Red Light Therapy Lights
- | Portable and Easy to Install
- | Designed and Made for Indian Conditions
- | 360° Far Infra-Red Emission for Uniform Heating
- | More Effective and Efficient than Imported Saunas
- | UV Protective, Zero EMF, and Negative Ion Generation
- | All-India Service and Installation Available
- | Customization Available in All Sizes and Features
- | Front Side Full Glass Door Option Available

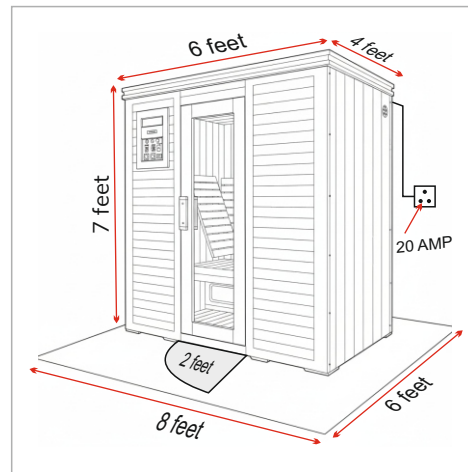
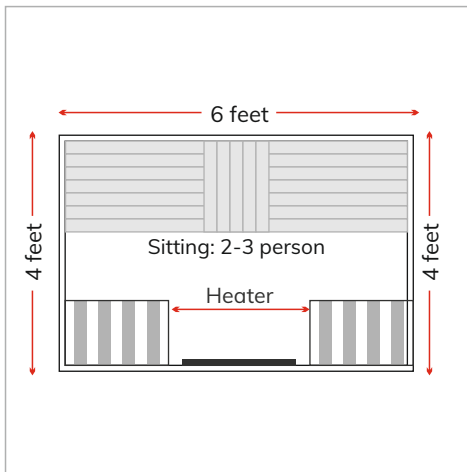
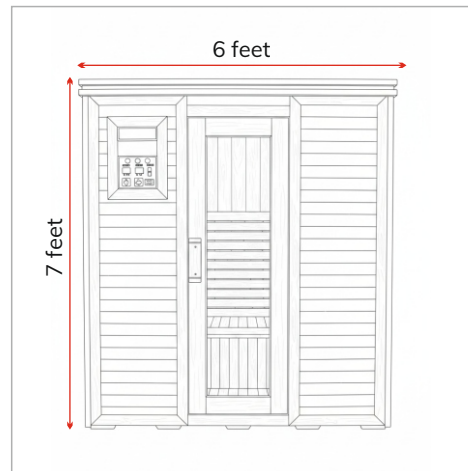
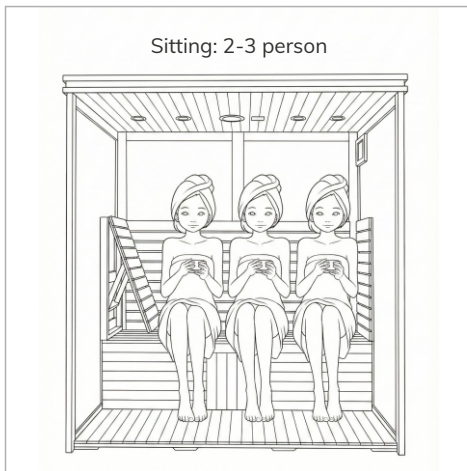

Technical Specifications



Dimensions:
6 x 4 x 7 feet
1830 x 1220 x
2135 mm



Area Required:
8x6 Sq. Feet
(48 Sq. Feet)



Electrical Power:
3200 Watts, 3.2KVA,
230V, 20 AMP Plug
(Single Phase) Point
with 4 sq mm wire



**Temperature
Range:**
65°C to 75°C



Infrared Type:
360° For Infrared
Emission



Heating System:
Concave Ceramic
Heaters
(Made in Germany)



Wavelength:
Full Spectrum
(2 to 10 microns /
2000-10000 nm)



Infrared Source Life:
Approx. 10,000
working hours



**Average Warm-Up
Time:**
30-40 minutes



Control:
Outside manual
control panel



Club Sauna

(6 x 6 feet)

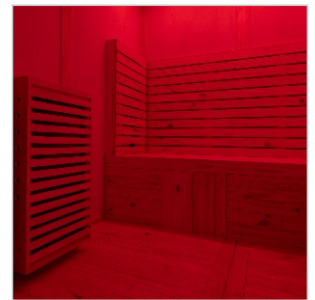

A perfect Sauna which has been designed keeping in mind the requirements of Heavy-duty usage. Available in 6'X6' size, you can also opt for a custom size as per your requirement. Heavy-duty, low maintenance, tough body and high-quality fittings and wiring are built to last and give you a smooth working.

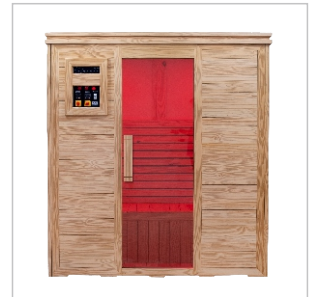

MATERIAL & DESIGN:

- | Wood Type: American Pine with Wall Grainy Veneers(Outer Surface)
- | Inner Walls: Bio Ceramic Nano Particle Coated
- | Type: Free Standing Portable Sauna Cabin
- | Color: Pine Wood
- | Front side glass door

FEATURES & HIGHLIGHTS

- | Inbuilt Bluetooth Music System
- | Red Light Therapy Lights
- | Portable and Easy to Install
- | Designed and Made for Indian Conditions
- | 360° Far Infra-Red Emission for Uniform Heating
- | More Effective and Efficient than Imported Saunas
- | UV Protective, Zero EMF, and Negative Ion Generation
- | All-India Service and Installation Available
- | Customization Available in All Sizes and Features
- | Front Side Full Glass Door Option Available

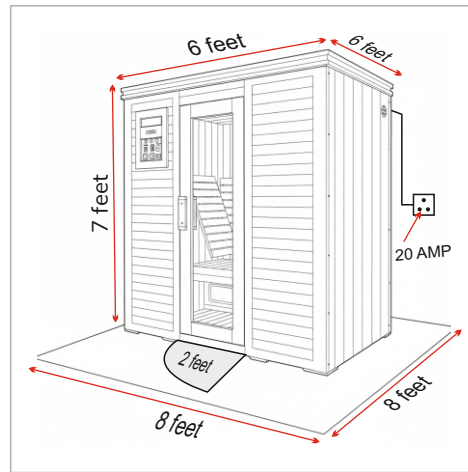
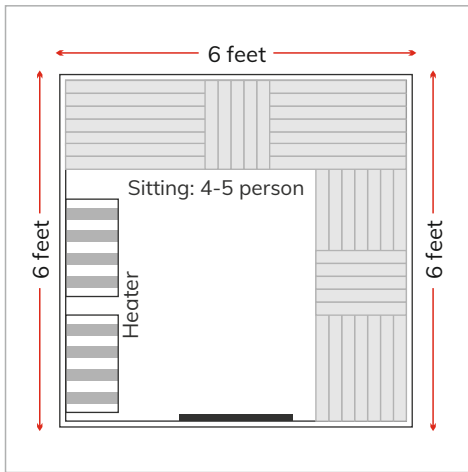
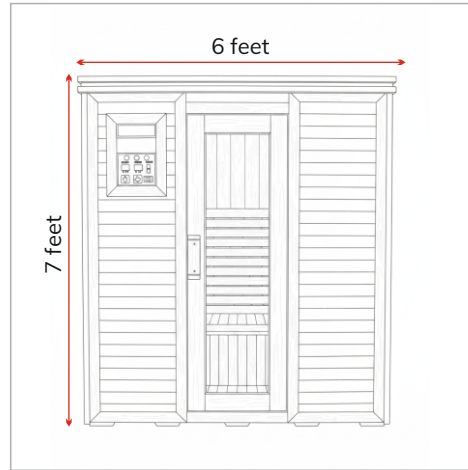
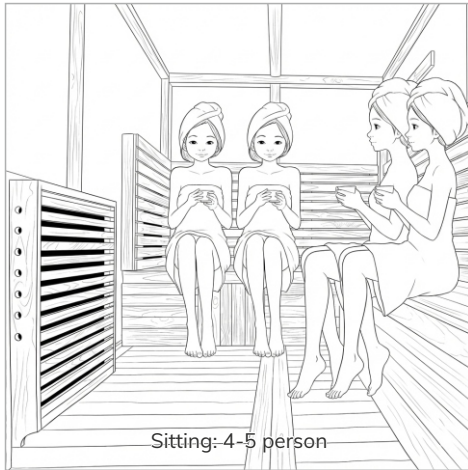

Technical Specifications



Dimensions:
6 x 6 x 7 feet
1830 x 1830 x
2135 mm



Area Required:
8x8 Sq. Feet
(64 Sq. Feet)



Electrical Power:
3600 Watts, 3.6KVA,
230V 20 AMP Plug
Point with 4 mm sq.
wiring (Single Phase)



**Temperature
Range:**
65°C to 75°C



Infrared Type:
360° For Infrared
Emission



Heating System:
Concave Ceramic
Heaters
(Made in Germany)



Wavelength:
Full Spectrum
(2 to 10 microns /
2000-10000 nm)



Infrared Source Life:
Approx. 10,000
working hours



**Average Warm-Up
Time:**
30-40 minutes



Control:
Outside manual
control panel



Club Zen Sauna

(8 x 8 feet)

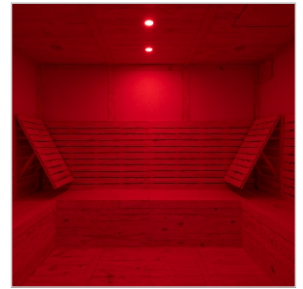

Blizz Club Sauna 8X8 is a powerpack Infrared sauna which comes with three sides sitting and with a capacity of 6 to 7 persons is an ideal sauna for clubs, resorts, hotels, spa and large size GYM's. Heavy duty build quality, is designed to work long day and cater your clients requirements. Spacious, comfortable, with build-in music, red-light therapy and advance controls which ensures to maintain right temperature inside the sauna.

MATERIAL & DESIGN:

- | Wood Type: American Pine with Wall Grainy Veneers (Outer Surface)
- | Inner Walls: Bio Ceramic Nano Particle Coated
- | Type: Free Standing Portable Sauna Cabin
- | Color: Pine Wood
- | Front side glass door

FEATURES & HIGHLIGHTS

- | Inbuilt Bluetooth Music System
- | Red Light Therapy Lights
- | Portable and Easy to Install
- | Designed and Made for Indian Conditions
- | 360° Far Infra-Red Emission for Uniform Heating
- | More Effective and Efficient than Imported Saunas
- | UV Protective, Zero EMF, and Negative Ion Generation
- | All-India Service and Installation Available
- | Customization Available in All Sizes and Features

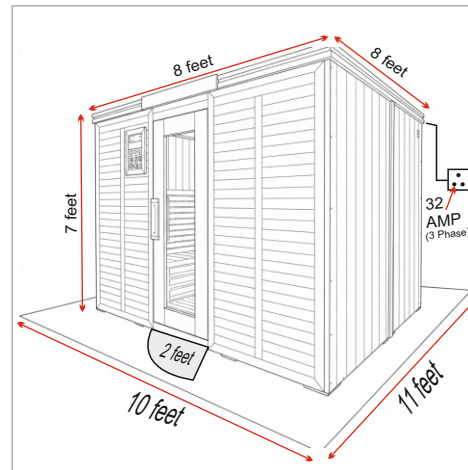
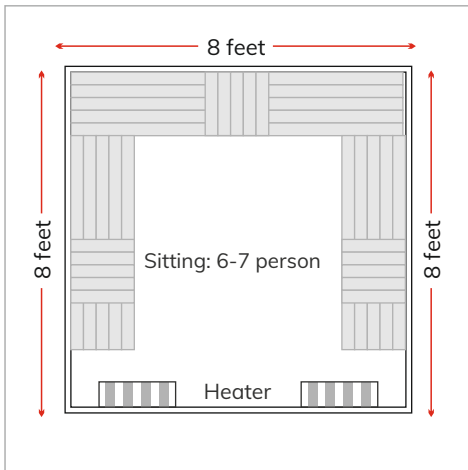
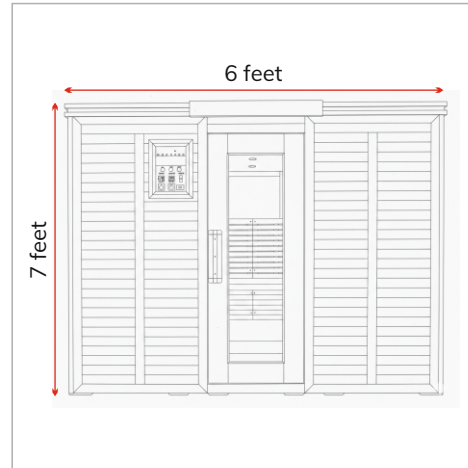
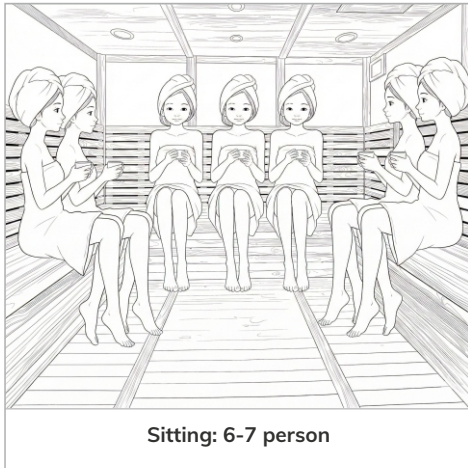

Technical Specifications



Dimensions:
8 x 8 x 7 feet
2440 x 2440
x 2135 mm



Area Required:
10x11 Sq. Feet
(110 Sq. Feet)



Electrical Power:
8000 Watts, 8 KVA
230 V, 32 AMP Plug
Point Three Phase



Temperature Range:
65°C to 75°C



Infrared Type:
360° For Infrared
Emission



Heating System:
Concave Ceramic
Heaters
(Made in Germany)



Wavelength:
Full Spectrum
(2 to 10 microns /
2000–10000 nm)



Infrared Source Life:
Approx. 10,000
working hours



Average Warm-Up Time:
30–40 minutes



Control:
Outside manual
control panel



Blizz Spectra

(6 x 4.5 feet)

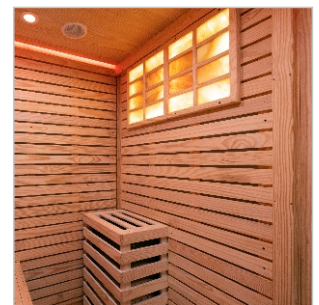
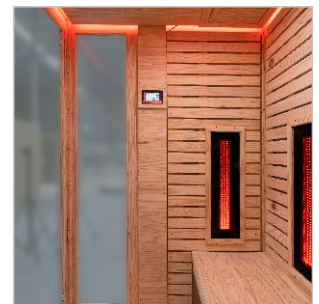
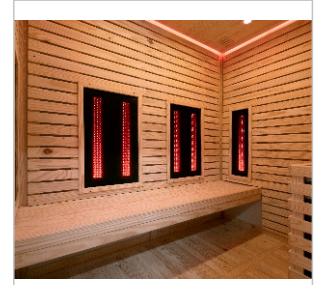

MATERIAL & DESIGN:

- | Wood Type: American Pine with Wall Grainy Veneers (Outer Surface)
- | Inner Walls: Bio Ceramic Nano Particle Coated
- | Type: Free Standing Portable Sauna Cabin
- | Color: Black
- | Glass Door with wooden handle
- | Double-layer heater guards

LIGHTING & AMBIENCE

- | Ambient multi-colour LED lighting
- | Focused ambient lighting on the ceiling
- | Red lights on the Back Panels
- | Red lighting accent strip for soothing sauna environment
- | Exterior LED lights
- | Red light on the floor

FEATURES & HIGHLIGHTS

- | Inbuilt Bluetooth Music System
- | 2 high-end speakers
- | Himalayan Salt Wall
- | Red Light Therapy Lights
- | Designed and Made for Indian Conditions
- | 360° Far Infra-Red Emission for Uniform Heating
- | More Effective and Efficient than Imported Saunas
- | UV Protective, Zero EMF, and Negative Ion Generation
- | Adjustable temperature and session timer settings
- | Overheat and safety protection system

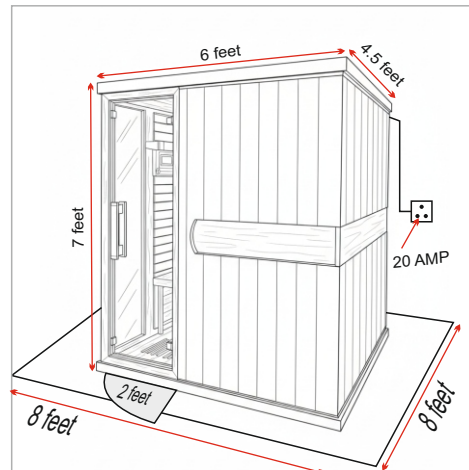
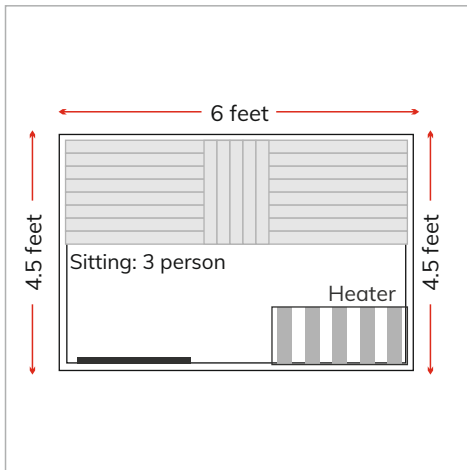
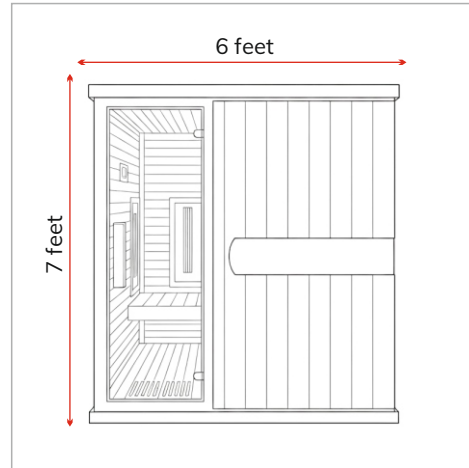

Technical Specifications



Dimensions:
6 x 4.5 x 7 feet
1830 x 1372 x 2134 mm



Area Required:
8x8 Sq. Feet
(64 Sq. Feet)



Electrical Power:
4000 Watts, 230V
20 AMP Plug Point
with 4 mm sq. wiring
(Single Phase)



Temperature Range:
60°C to 75°C



Infrared Type:
360° For Infrared
Emission



Heating System:
Concave Ceramic
Heaters
(Made in Germany)



Wavelength:
Full Spectrum
(2 to 10 microns /
2000–10000 nm)



Infrared Source Life:
Approx. 10,000
working hours



Himalayan Salt Wall



Control:
Digital touch
control panel
(inside mounted)



Blizz Solace

(6 x 6 feet)



MATERIAL & DESIGN:

- | Wood Type: American Pine with Wall Grainy Veneers (Outer Surface)
- | Inner Walls: Bio Ceramic Nano Particle Coated
- | Type: Free Standing Portable Sauna Cabin
- | Color: Pine Wood
- | Glass Door with wooden handle
- | Double-layer heater guards

LIGHTING & AMBIENCE

- | Ambient multi-colour LED lighting
- | Focused ambient lighting on the ceiling
- | Red lights on the Back Panels
- | Red lighting accent strip for soothing sauna environment
- | Exterior LED lights
- | Red light on the floor

FEATURES & HIGHLIGHTS

- | Inbuilt Bluetooth Music System
- | 2 high-end speakers
- | Himalayan Salt Wall
- | Red Light Therapy Lights
- | Designed and Made for Indian Conditions
- | 360° Far Infra-Red Emission for Uniform Heating
- | More Effective and Efficient than Imported Saunas
- | UV Protective, Zero EMF, and Negative Ion Generation
- | Adjustable temperature and session timer settings
- | Overheat and safety protection system

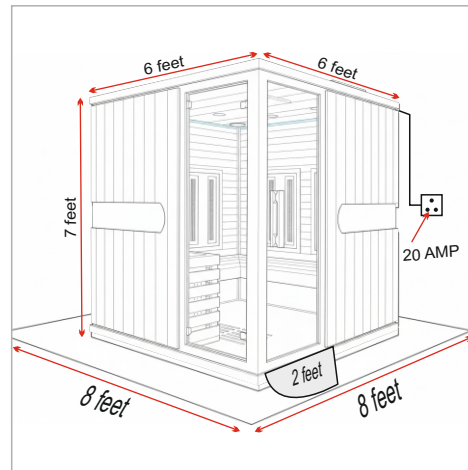
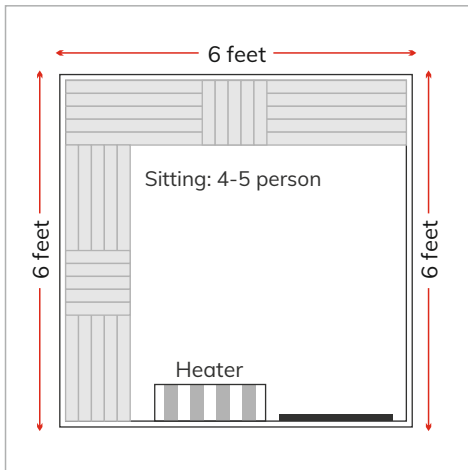
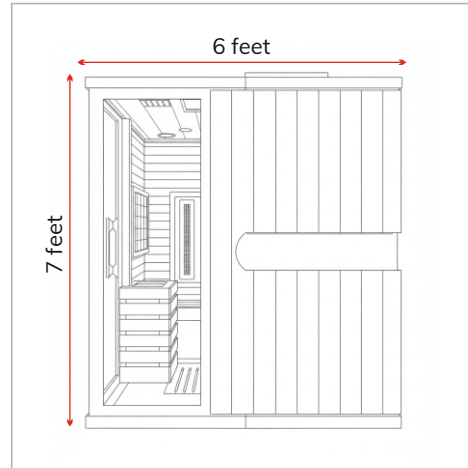
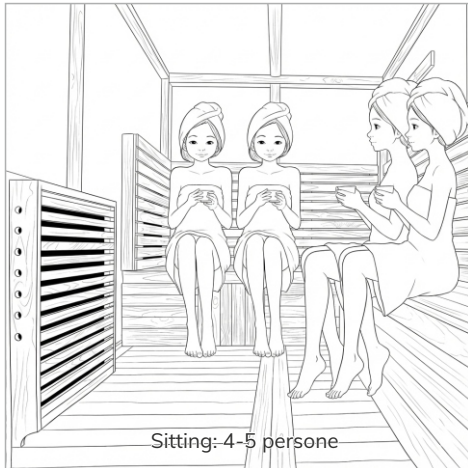

Technical Specifications



Dimensions:
6 x 6 x 7 feet
1830 x 1830 x
2135 mm



Area Required:
8x8 Sq. Feet
(64 Sq. Feet)



Electrical Power:
4000 Watts, 230V
20 AMP Plug Point
with 4 mm sq. wiring
(Single Phase)



Temperature Range:
60°C to 75°C



Infrared Type:
360° For Infrared
Emission



Heating System:
Concave Ceramic
Heaters
(Made in Germany)



Wavelength:
Full Spectrum
(2 to 10 microns /
2000-10000 nm)



Infrared Source Life:
Approx. 10,000
working hours



Himalayan Salt Wall



Control:
Digital touch
control panel
(inside mounted)



Custom Sauna

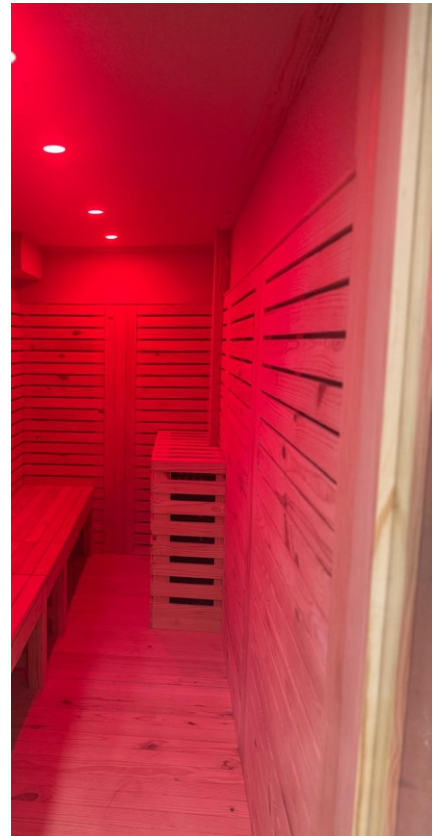





Himalayan Salt Wall



The Himalayan Salt Wall is an optional add-on available for all infrared sauna models. It is not included in the standard package and is offered at an additional cost.

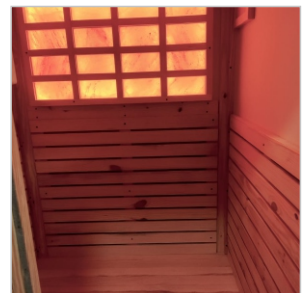
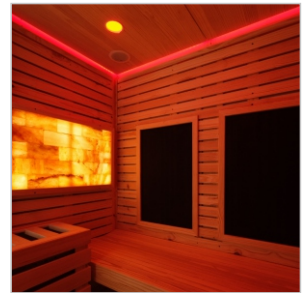

WHAT HIMALAYAN SALT THERAPY INVOLVES

When Himalayan salt is used in a sauna or salt room, tiny salt particles and minerals may be released into the air, creating an environment similar to traditional halotherapy. This is thought to simulate the effects of salt caves where saline-rich, dry air is inhaled.

SALT + INFRARED SAUNA = TWO THERAPIES IN ONE

Infrared saunas use far-infrared heaters to directly warm your body at lower ambient temperatures than traditional steam saunas but still induce sweating and heat stress. Himalayan salt adds an element of salt therapy to this heat exposure.

HIMALAYAN SALT + INFRARED SAUNA MAY PROVIDE BENEFITS SUCH AS:

- | **Respiratory Support:** Salt particles may help reduce airway inflammation
- | **Relaxation & Stress Relief:** Help reduce stress, promote relaxation, and may improve mood.
- | **Improved Circulation:** May improve blood flow and nutrient delivery to tissues.
- | **Skin Health:** Salt's antibacterial and anti-inflammatory properties improves skin health
- | **Muscle Relaxation & Pain Relief:** Ease stiffness and discomfort after exercise or chronic tension.
- | **Sleep & Mental Well-Being:** Warmth + relaxation may support better sleep quality



Meso Therapy

(8 x 4 feet)

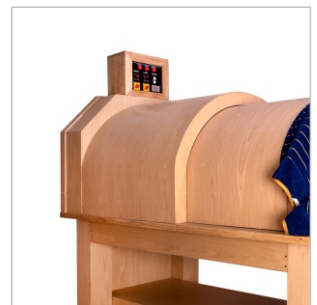
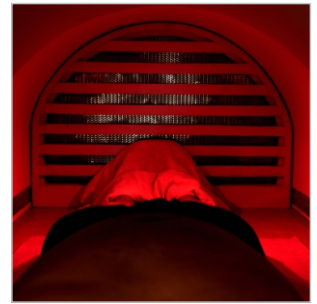

Blizz Meso Therapy is a Far-infrared based specific area fat reduction system developed by Blizz Infrared Sauna. It is the most effective non-invasive therapy for losing visceral fat whose accumulation is the source of most lifestyle diseases. Blizz Meso Therapy or Non-invasive body contouring Non-invasive FIR Meso-therapy chamber delivers 100 out of 100 times. Conventional Meso-therapy is one of the most successful currently prevalent, and less invasive methods of fat reduction, lipolysis and found effective in controlling localized sub cutaneous fat deposits, this method is practiced by leading plastic, cosmetic surgeons worldwide and in India.

HIGHLIGHTS

- | 24 months warranty
- | 8-10 hours of working (Heavy duty commercial product)
- | 360 Degree Far Infra-Red emission
- | All India service and installation available
- | Customization available in all features and sizes
- | Advance technology of weight reduction
- | Healthy way of breaking down the visceral fat
- | Break down accumulated fat from abdomen n gives reduction of minimum 2-3 inches just in single session.
- | One of the best systems of figure correction and general slimming.
- | Natural way of fat excretion through sweat, urine, and motion.

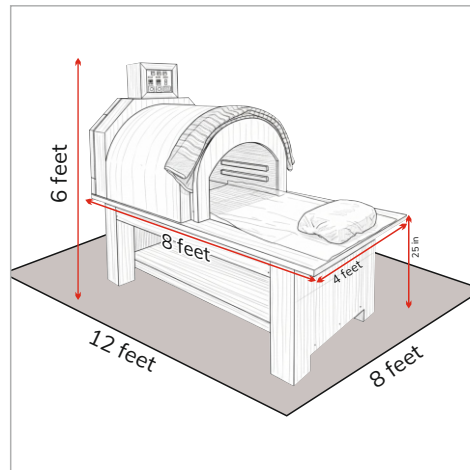
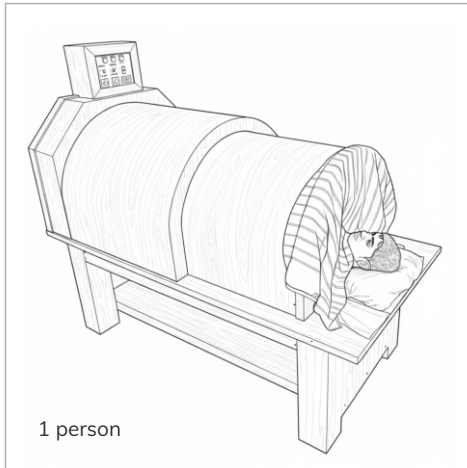

Technical Specifications



Dimensions:
Length: 8 feet
Width: 4 feet
Height: 6 feet



Area Required:
8x12 sq feet



Electrical Power:
2000
2 KVA
230 V



Temperature Range:
40°C to 60°C



Infrared Type:
360 Degree
Far Infrared
emission



Heating System:
German Made
Concave emitters



Point Required
15 AMP
Single Phase
4 mm sq. wiring

BLIZZ[®]

INFRARED SAUNA

Synergy - Safety - Sustainability

What makes Blizz infrared sauna unique is the various technologically innovative elements which have been put together in such a way that they create synergy, safety, health, more benefits, no maintenance and years of happiness.



The Problem

Toxic Planet and its Toxicity affects our body organs and functionality

Damages Cells affecting Mitochondria and DNA

Impurities into main blood Stream flow into the various cells, tissues, heart, vital organs including the brain.

Destruct our Nerve Tissue, Im-balancing the stress hormones.

Impair on Respiratory Functions resulting to acute and chronic conditions.

As the level of toxic burden grows, the Liver gets more sluggish and unable to perform its detoxification process.

Toxic wastes leaks and damages our Gut system which includes digestive system, digestive tract, stomach, pancreas, small intestine colon and rectum.

Poor functioning of Kidneys due to elevated toxic waste levels are unable to filter and remove toxins through urinary system.

The Solution

Far Infrared Detox Therapy: Total Body Detoxification

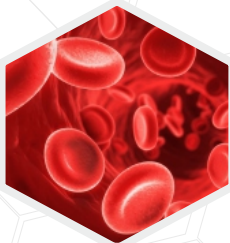

CELLS



BLOOD



BRAIN



GUT



LIVER

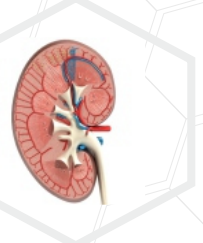

KIDNEY

FIR Detox Care the most unique Cleansing; full Body Detox therapy

Our Total Body Detoxification therapy is a unique naturopath program to detox the body from toxins and literally reset cleanse and heal every organ in the body.

Today once can find different detox programs; some focus on Colon, some on losing weight and others on Liver. Although all will have some benefit, none will impact on Overall Health as a full body, organ focused detox.

Proven and tested Technology by NASA

Far Infrared Detox Therapy involves the use of Far Infra-Red rays to gently heal, soothe, stimulate and detox the body as well as the mind. The profuse sweating achieved after a few minutes in Detox Care therapy carries off deeply embedded impurities, dead tissues and toxins. This detoxification is know as the Safest natural Naturopath Therapy for sweating and relaxation.

How our Far Infra Red Detox Therapy Works ???

Resonance

Far infrared HEAT elevates body temperature producing an increase in blood flow that mirrors the benefits of a passive cardiovascular workout. In fact, blood flow during Far infrared Therapy use has been reported to rise from a normal rate of 5-7 quarts per minute to as much as 13 quarts per minute. Increased blood circulation delivers vital oxygen and nutrients to limbs, cells and brain making the body function at its best capacity.

Inducement

Far infrared heat expands the arteries and blood vessels inducing increased blood circulation. This makes the heart pump faster increasing heart rate, cardiac output and metabolic rate. Research and scientific evidence confirms that using far infrared Therapy regularly lowers blood pressure and improves heart health. Relax and get your heart in shape.

Stimulation

Far infrared HEAT stimulates the blood circulatory system, which causes the heart to beat more vigorously and blood vessels to dilate. This helps cleanse the circulatory system and delivers oxygen and nutrients to the body's cells. Improved blood circulation means toxins flow from the cellular level to the skin's surface to improve cell health and strengthen the immune system.

Elimination

Far infrared HEAT increases core body temperature, which expands capillaries resulting in increased blood circulation. This causes heart to pump faster and increases metabolic rate, burning up to 600-900 calories in one session Which is equivalent to 9-10 km jog. Far infrared HEAT can also help rid the body of cellulite, which is a gel like substance made up of fat cells, water and wastes. So, sit back, relax and let the pounds and fat melt away in the most comfortable relaxing setting.

Penetration

Far Infrared HEAT is one of the best treatments for strains, muscle spasms and other injuries. Improved blood circulation means toxins flow from the cellular level to the skin's surface to improve cell health, assist in Muscle recovery

Far Infrared HEAT works by penetrating joints, muscles and tissues, speeding oxygen flow and increasing blood circulation.

Balancing

Far Infrared therapy has been clinically shown to reduce both systolic and diastolic blood pressure with regular use able to find more effective and complete therapy to induce deeper relaxation and tension relief. Stress makes our body release cortisol, which is a "fight or flight" hormone made in adrenal glands that raises heart rate and blood pressure and leads to the deposit of excess calories in the midsection. Scientific evidence confirms that FIR helps the body maintain healthy levels of cortisol.

Rejuvenation

Rejuvenate your skin from the inside out. The increased blood circulation of the skin brings fresh nutrients to the surface.

At the same time, profuse sweating is assisting in the removal of toxins that accumulate deep within pores such as make-up, dirt, cream, lotions and conditioners.

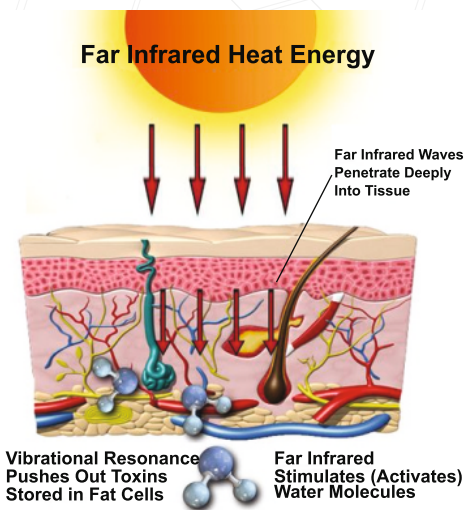

- Improves Blood Circulation & Metabolic Function
- Cleanses the Body of Harmful Toxins

Let FIR get under your Skin

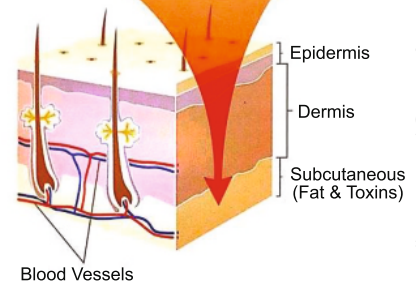

FIR is an effective tool for detoxification and breaking down of body fats.
Far Infrared is the invisible spectrum that is essential for the well-being of all living things and are easily absorbed by the human body. The warmth you feel is the infrared penetrating your body 4 to 9 Centimeters. This promotes blood Circulation and enhances the body's immune system.

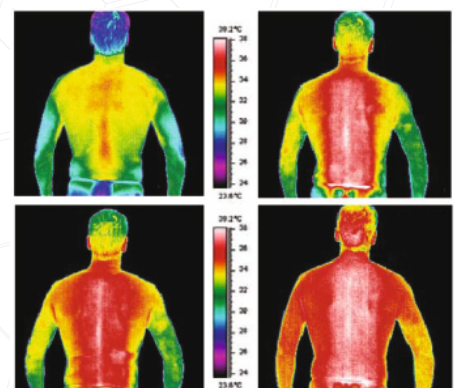

BLIZZ[®]

INFRARED SAUNA

Blizz Infrared Sauna

105-106 Samaan -2
Anand Nagar Road,
Prahlad Nagar, Ahmedabad,
Gujarat-380015

+91 - 98250 38480

info@infraredindia.com

linesformanish@gmail.com

www.blizzbiosculpting.com/

www.infraredindia.com/

