

CONCRETE CONSOLIDATION

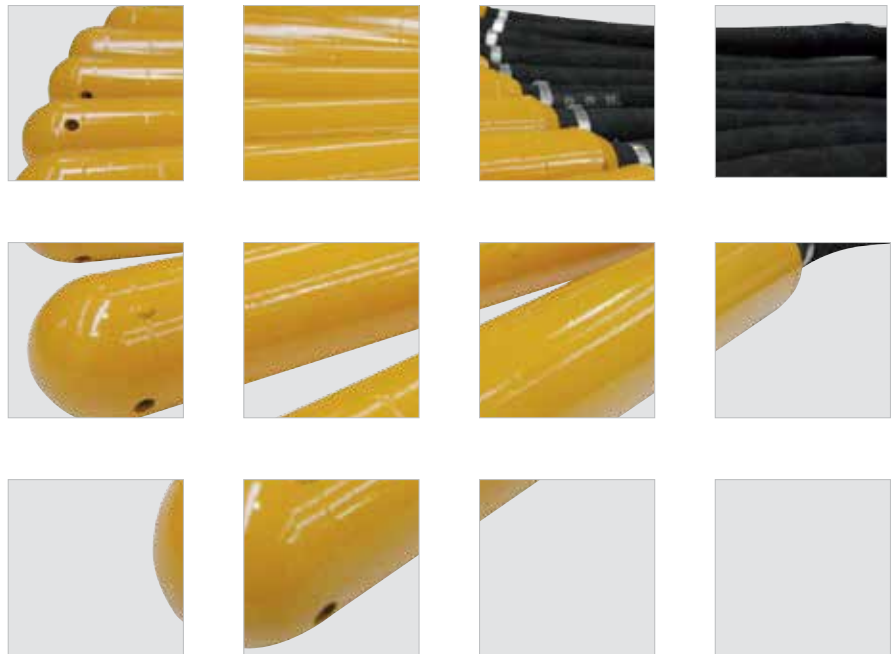

THE WORLDWIDE LEADER IN VIBRATION TECHNOLOGY







Intro

Company profile	4
Vibration of concrete	5

In situ concrete consolidation

High frequency internal vibrators	6
Frequency and voltage converters	8
High frequency internal vibrators with built-in converter	10

Precast concrete consolidation

External electric vibrators	12
Fastening systems	15
External pneumatic vibrators	16

Extra

Tips and recommendations for use	18
----------------------------------	----



Worldwide leader in vibration technology

OLI is the world's top selling manufacturer of Electric and Pneumatic Vibrators.

A high level of customer service is guaranteed through 19 OLI Trading Subsidiaries, 36 local warehouses and 5 manufacturing plants worldwide.

OUR 3 DIVISIONS

PROVIDE CUSTOMERS WITH OPTIMAL SOLUTIONS FOR ALL REQUIREMENTS

INDUSTRIAL VIBRATORS	FLOW AIDS	CONCRETE CONSOLIDATION
 <p>Electric motovibrators for vibrating equipments.</p>	 <p>Comprehensive range of electric and pneumatic vibrators to solve any problem of flowability.</p>	 <p>Internal concrete vibrators and converters for reliable and efficient concrete compaction.</p>

Originally specialising in immersion vibrators for concrete consolidation, OLI is now the worldwide leader in vibration technology, with a **complete range of electric and pneumatic internal and external vibrators**.

By supplying **competitive, high quality products for wide-ranging applications**, OLI combines **performance** and **reliability** by adapting to the ever-changing market. A strong believer in innovation, OLI is constantly striving to be ahead of the opposition.

As a global player in industrial vibration technology, the key focus of OLI's business strategy is **rapid stock delivery, any time, anywhere in the world**.

Excellent customer service is of pivotal importance: the company guarantees **quick order processing** and customers worldwide can enjoy access to the same high quality product and services.

OLI has access to credible expertise when it comes to finding suitable solutions to customers' requests. A team of engineers specialised in designing efficient, reliable, and safe solutions backed by **globally certified management**.

OLI provides their customers with state-of-the-art equipment and the blueprint for the next generation of products is already in progress.

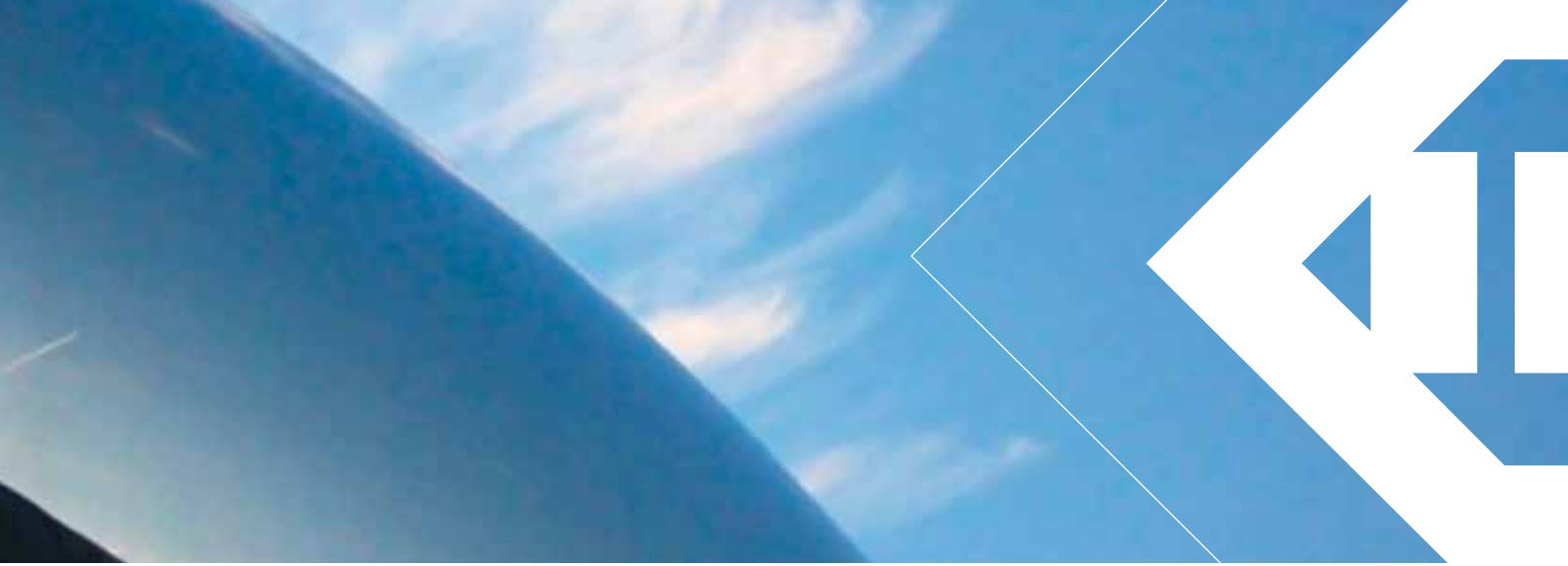

The vibration of concrete

The freshly mixed concrete does not compact on its own because the poor fluidity is not able to overcome the internal friction; only vibration can overcome such forces.

VIBRATION FAVOURS:

- The **surfacing of the air** trapped in the concrete;
- The **displacement of aggregates**, aligning them to one another, with consequent reduction of cavities, conferring them high density and perfect homogeneity;
- The **adhesion** of the concrete to the bars of the reinforcement armatures or to any internal structural inserts, as well as to the basic anchorages.

BENEFITS:

- High **mechanical resistance**.
- Low porosity and thus **low permeability** to water and to aggressive substances contained therein.
- **Absence of cracks** within the concrete, in the proximity of the reinforcement armatures' bars.
- **Complete filling** of the formwork.
- **Increase in the life cycle** of the concrete.
- High **aesthetic result**.

TYPES OF VIBRATION	➔	EQUIPMENT TO USE
<p>Direct The vibration is transmitted directly from within the concrete</p>	➔	Electric immersion vibrators
<p>Indirect The vibration is transmitted from the outside of the concrete</p>	➔	External electric and pneumatic vibrators

NO VOIDS

REDUCED WORKING TIME

MAXIMUM DENSITY

MAXIMUM CONCRETE STRENGTH WITH OLI VIBRATORS



Electric high frequency internal vibrators

When constructing industrial floors, walls, columns, slabs, etc., **flexible and easy-to-use vibrating systems** are required.

In such cases high-frequency immersion vibrators are generally used, known as “poker” or “spud” or simply “vibrating needles”, which come into **direct contact with the concrete**; for this reason, we speak of internal direct vibration.

HOW THE VH VIBRATORS WORK:

An eccentric mass is housed inside the vibrating head (or needle) which is fixed to a shaft rotated by a three-phase asynchronous AC motor.

During rotation, the eccentricity of the mass generates rotational movements to the vibrating head (vibrations).

The **robustness** and the **constant rotation speed** are essential factors in the compaction of the concrete: drops in the centrifugal force heavily penalise the quality of the manufactured article.

The VH is a robust and reliable product, which is suitable for compacting concrete and is appropriate for continuous operation.

Important:

The VH have to be operated by electric and electronic converters that convert the 50/60 Hz mains frequency to 200 Hz, which is necessary in order for the vibrating head to reach a vibration speed of 12,000 vpm, as it is ideal for the proper compaction.



Benefits

- No overheating
- Easy maintenance
- Long life of the vibration head
- Perfect water tightness

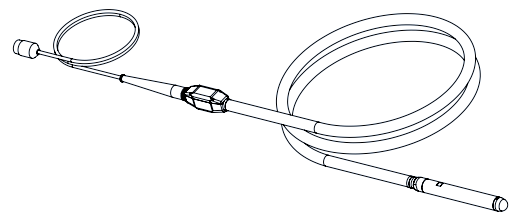

MAXIMUM DURABILITY
HIGH PERFORMANCE



VH - Electric high frequency internal vibrators

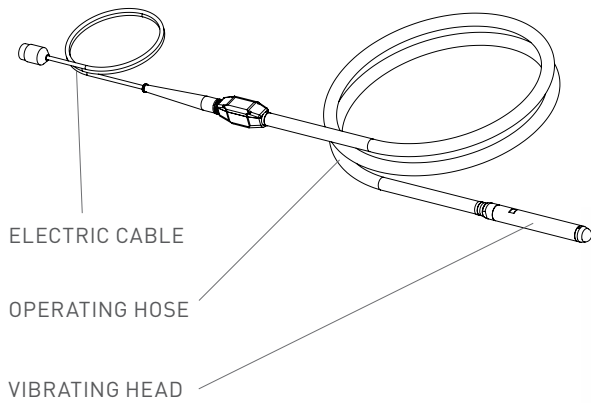

MODEL	HEAD DIAMETER	HEAD LENGTH	HEAD WEIGHT	TOTAL WEIGHT*	CF	RATED CURRENT **	RATED POWER (42V)	ACTION DIAMETER ***	AMPLITUDE	NOISE LEVEL	COMPACTION POWER***
	mm	mm	kg	kg	N	A	kW	cm	mm	dB A	m³/h
VHN 38	38	404	2.4	10.6	1,700	8	0.5	45	1.8	70	20
VHN 50	50	403	4.4	14.8	3,080	11	0.6	60	2	76	25
VHN 59	59	420	6.8	17.4	4,560	12	0.9	80	2.3	76	35
VHP 50	50	468	5.4	16.4	3,760	15	0.9	70	2.1	76	40
VHP 59	59	498	8.2	19.6	5,640	17	1.1	90	2.4	79	45
VHP 65	65	484	9.4	22.4	7,330	24	1.3	110	2.6	79	50

* Packaging included ** Refer to centrifugal force for amperage assessment *** Measurements vary according to concrete quality and thickness

VH - ELECTRIC HIGH FREQUENCY INTERNAL VIBRATORS

APPLICATION	Concrete compaction
DESCRIPTION	High frequency internal electric vibrators for concrete consolidation characterised by high performances, consistent speed and remarkable resistant to abrasion

FEATURES

DUTY CYCLE	Continuous S1
INPUT	42V-3ph - 200Hz
NOMINAL FREQUENCY	12,000 vpm
INSULATION CLASS	F (T° max = 155°C)
THERMAL SWITCHES	Inside the stator. Max T°C = 150°C
WORKING TEMPERATURE	From -20°C to +40°C
HEAD	Equipped with ball bearings greased for life. 2 bearings (VHN 50 - VHN 59), 4 bearings (VHN 38 and complete VHP range) Protection class IP68 Hardening treatment for VHN and chrome plating for VHP
SWITCH BOX	Polyamide (nylon +30% fiber glass) with gasket, cable protection, yellow colour IP66 protection Designed for continuous use and resistant to wear and tear
OPERATING HOSE	5m SBR rubber hose with inner textile reinforcement
SUPPLY CABLE	10m neoprene electric cable HO7RN-F with 3 pin plug (42V - 3 phase, IP44)
FINISHING	Painted orange Ral 1007 (VHN), chromed (VHP)
CERTIFICATIONS	Community Directives and subsequent modifications: 2006/42/EC - 2006/95/EC Conformity verified according to the standard documents: IEC 60745-1, IEC 60745-2-12, IEC 60034-1
OPTIONS	Cast aluminium switch box Rubber cap



Frequency and voltage converters

The internal vibrating needles need to be powered via a three-phase electric line at low voltage, therefore it is necessary to use a voltage and frequency converter.

The electromechanical rotary converters consist of a motor and a generator, which are coupled together. The motor converts the electrical energy into mechanical energy; the generator converts the mechanical energy into electrical energy, thus generating the required voltage and frequency (42 Volt - 200 Hz).

The converters of the CM range are designed to supply simultaneously and in a continuous cycle one or more high-frequency internal vibrators; they are reliable, durable and do not require maintenance.

The minimal design and the materials used **facilitate the external cleaning**, while the special internal air ducting system **avoids overheating**. The range offers several models, which are **capable of supplying from 1 to 4 immersion vibrators**.



Benefits

- No overheating
- No maintenance
- Optimal cooling
- Easy cleaning

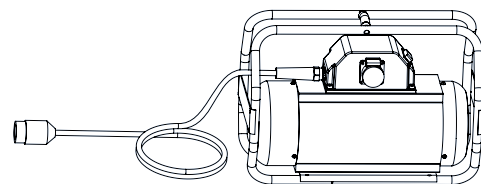

LONG LIFE
OPTIMUM COOLING



CM - Frequency and voltage converters

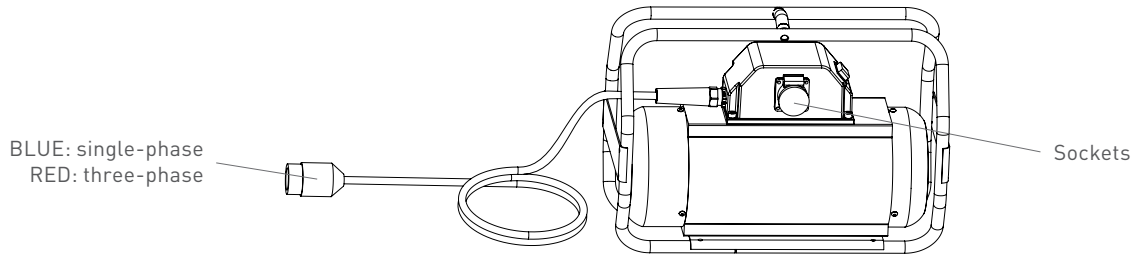

MODEL	FRAME	OUTLETS	SUPPLY ELECTRIC CABLE	WEIGHT	INPUT			OUTPUT		
					VOLTAGE	CURRENT	POWER	VOLTAGE	CURRENT	POWER
					Type	n°	m	kg	V	A
CMM 15	Handle	1	3.5	25	230V, 1ph, 50Hz	6	1.1	42V ± 10% 3ph 200Hz	14	1
CMM 25	Frame	2	34	10		1.8	25		1.8	
CMT 25	Frame	2	3.5	33	400V 3ph 50Hz	5	2.8		25	1.8
CMT 35	Wheeled	3	5.0	41		6	3.3		36	2.6
CMT 55	Wheeled	3	5.0	50		9	5		55	4
CMT 85	Wheeled	4	5.0	56		12	6.6		85	6.2

COMPATIBILITY TABLE (maximum number of vibrators that can be connected)							
CMM 15	1x VHN 38	1x VHN 50	1x VHN 59	-	-	-	-
CMM 25	2x VHN 38	2x VHN 50	2x VHN 59	1x VHP 50	1x VHP 59	1x VHP 65	
CMT 25	2x VHN 38	2x VHN 50	2x VHN 59	1x VHP 50	1x VHP 59	1x VHP 65	
CMT 35	3x VHN 38	3x VHN 50	3x VHN 59	2x VHP 50	2x VHP 59	1x VHP 65	
CMT 55	3x VHN 38	3x VHN 50	3x VHN 59	3x VHP 50	3x VHP 59	2x VHP 65	
CMT 85	4x VHN 38	4x VHN 50	4x VHN 59	4x VHP 50	4x VHP 59	3x VHP 65	

CM - FREQUENCY AND VOLTAGE CONVERTERS

APPLICATION	Concrete compaction
DESCRIPTION	Frequency and voltage converters equipped with permanent magnets, specifically designed to power high frequency concrete vibrators continuously

FEATURES

DUTY CYCLE	Continuous S1
INSULATION CLASS	F (T° Max = 155°C)
PROTECTION	Overload protection
WORKING TEMPERATURE	From -20°C to +40°C
CONNECTION BOX	Polyamide (nylon + 30% fibre glass), complete with switch and sockets (42V three phase, IP44 protection)
SUPPLY CABLE	Neoprene electric cable H07RN-F with plug
FINISHING	Powder coating (body orange Ral 1007; fan covers, wheels and frame black Ral 9007)
CERTIFICATIONS	Community Directives and subsequent modifications: 2006/42/EC - 2006/95/EC Conformity verified according to the standard documents IEC 60034-1, IEC 60745-1, UNI EN ISO 12100
MORE	Smooth and robust cast aluminium body Forced ventilation



High frequency internal vibrators with built-in converter

On construction sites, during the consolidation of the concrete, a light, flexible and easy-to-use tool is often required, which **can be connected directly to the common, single-phase power lines** (110/230 Volt, 50/60 Hz).

In order to solve this necessity, the **EWO** range has been developed: **high-frequency immersion vibrators equipped with an integrated electronic frequency converter** capable of transforming the single-phase input voltage (230 V, 50/60 Hz) into the three-phase voltage (230 V, 200 Hz) necessary to obtain 12,000 vpm.

Compared to the common vibrating needles powered by electromechanical converters, the EWO has several advantages:

- they are **light and flexible**;
- the constant output frequency maintains the maximum centrifugal force and thus a **high and constant performance**;
- there is **protection** against short circuits, excessive temperature, voltage and current above or below the nominal values.



Benefits

- Reliable
- Safe & easy to handle
- No overheating
- Easy maintenance

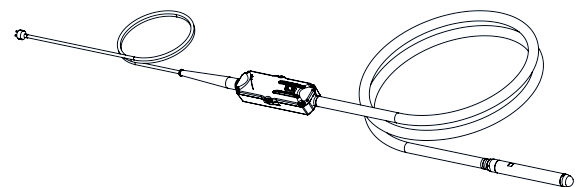

COMPACT SOLUTION



EWO – High frequency internal vibrators with built-in converter

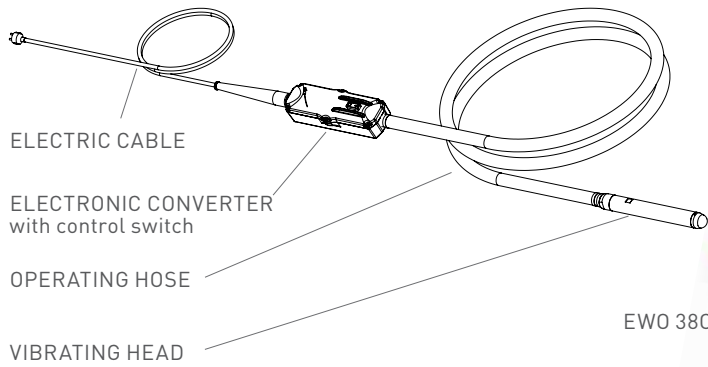

EWO 50C
EWO 59C
EWO 65C

EWO 38C



MODEL	HEAD DIAMETER	HEAD LENGTH	HEAD WEIGHT	TOTAL WEIGHT*	CF	RATED CURRENT **	RATED POWER [42V]	ACTION DIAMETER ***	AMPLITUDE	NOISE LEVEL	COMPACTION POWER ***
	mm	mm	kg	kg	N	A	kW	cm	mm	DB A	m3/h
EWO 38C	38	404	2.4	14.5	1,700	1.5	0.5	45	1.8	70	20
EWO 50C	50	468	5.2	20	3,760	2.7	0.9	70	2.1	76	40
EWO 59C	59	499	8.2	22.8	5,640	3.0	1.1	90	2.4	79	45
EWO 65C	65	484	9.4	24.8	7,330	4.5	1.3	110	2.6	79	50

* Packaging included ** Refer to centrifugal force for amperage assessment *** Measurements vary according to concrete quality and thickness

	Input Voltage	Input Frequency	Input Amperage
Converter	230V +10% -15% 1ph	50/60Hz ± 5%	5.5 A

EWO - HIGH FREQUENCY INTERNAL VIBRATORS WITH BUILT-IN CONVERTER

APPLICATION	Concrete compaction
DESCRIPTION	Equipped with compact electronic frequency converters integrated into the supply cable, characterised by high centrifugal forces, constant speeds and high wear resistance

FEATURES

DUTY CYCLE	Continuous S1
INPUT	230V + 10% - 15% 50/60 Hz -1 ph
NOMINAL FREQUENCY	12.000 vpm
INSULATION CLASS	F (T° max = 155°C)
PROTECTION CLASS	Head protection IP68 Converter protection IP66 The inverter is protected against overload, overvoltage, excess temperature and short circuit. A LED light shows the presence of a fault
WORKING TEMPERATURE	From -20°C to +40°C
HEAD	Equipped with 4 ball bearings greased for life Hardening treatment (EWO 38C), chrome plating (EWO 50C, EWO 59C, EWO 65C)
SWITCH BUILT-IN	Complete with reinforced gasket
PROTECTION HOSE	5m SBR rubber hose with textile reinforcement
SUPPLY CABLE	10m neoprene electric cable H07RN-F with SCHUKO 220V 2P+1T 16A plug
CONVERTER	Sturdy cast aluminium box Ergonomic and lightweight (3 Kg)
INVERTER	Tropicalised and protected against vibration, moisture and shocks with a special resin
FINISHING	Painted orange RAL 1007 (EWO 38C) and chrome plating (EWO 50C - EWO 59C - EWO 65C)
CERTIFICATIONS	Community Directives and subsequent modifications: 2006/42/EC, 2014/30/EU, 2006/95/EC Conformity verified according to the standard documents IEC 60745-1, IEC 60745-2-12, UNI EN ISO 12100
OPTIONS	Rubber cap



External electric vibrators

High frequency electric vibrators are used on construction sites and in precast companies to obtain high-quality products (exposed concrete), with **excellent aesthetic results and weather resistance**. The vibration is transmitted to the concrete **indirectly** through formworks or mould.

Just like the internal vibrators, the external ones are also based on the principle of the vibration produced by the rotation of an eccentric mass started by a three phase electric motor.

The OLI range of external electric vibrators includes fixed frequency models, 3,000 and 6,000 vpm, and variable frequency models, from 0 to 6,000 vpm.

Low speed vibration is used on high-density and unreactive concretes mostly, as they allow a fast displacement of the aggregates.

High speed vibration (6,000 vpm) is recommended with low-density concretes and in applications where high surface quality is required.

Variable frequency allows to find the correct vibration speed in relation to the density of the concrete to be treated. They are obviously more flexible than earlier.

The OLI external electric vibrators are characterised by **high operating efficiency** and **ease of installation**. Specially designed attachment devices (quick-coupling clamps) reduce the time required for installing and repositioning.

This vibration system is recommended when:

- High construction elements and narrow walls (partitions, columns, beams) are to be compacted, which are difficult to vibrate with other systems.
- The reinforcement density inside the housing is high.



Benefits

- Sturdy design, made to last
- High operating efficiency
- Easy to install

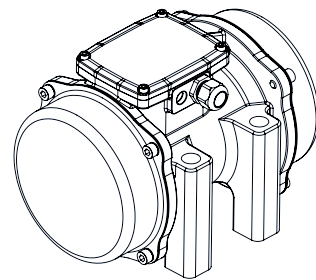

RELIABLE



Electric vibrators - FOOT

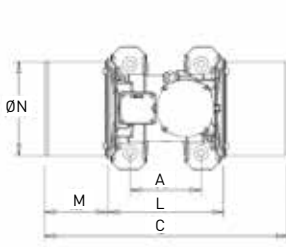
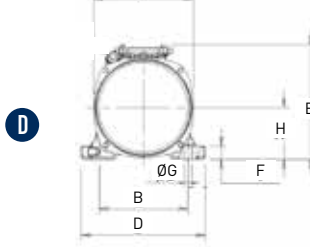
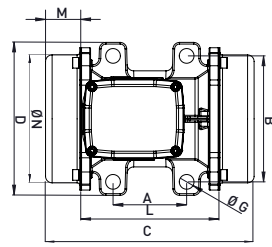
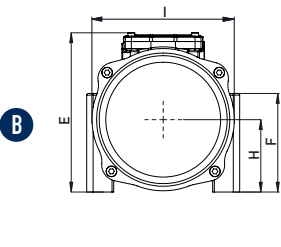
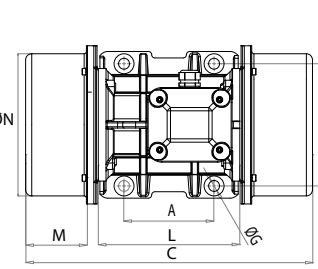
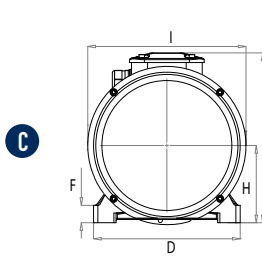
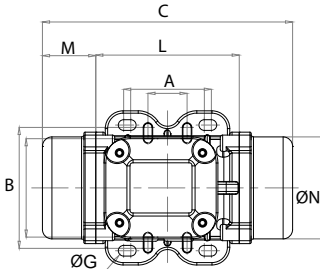
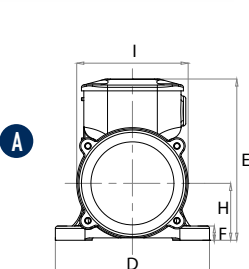

Wm kgcm	MODEL	WEIGHT kg	CENTRIFUGAL FORCE kg	RPM	ELECTRICAL SPECIFICATIONS						CERTIFICATE	
					INPUT POWER kW	FREQUENCY Hz	NOMINAL CURRENT A max.		POWER FACTOR	la / In	CABLE GLAND Metric	Ex II3D
1.47	MVE 290/6	4.6	294	6,000	0.27	200Hz	5.00	0.91/0.53A	0.75	2.00	M20	100°C
7.00	MVE 1500/6N-HF-38E	12	1,385	6,000	1.00	200Hz	15.00	2.80/1.60	0.90	4.00	M20	100°C
7.32	MVE 1300/6	24	1,474	0÷6,000	1.30	0÷100Hz	on request	4.24/2.44	0.77	3.10	M20	100°C
13.00	VFV 100 25/6	42	2,600	0÷6,000	2.25	0÷100Hz	on request	7.96/4.60	0.71	5.50	M20	on request

MODEL	DRAWING	SIZE	DIMENSIONAL SPECIFICATIONS (mm)												
			C	M	A	B	ØG	HOLES	D	E	F	H	I	L	N
MVE 290/6	A	10	211	45	62-75 / 33	106 / 83-102	9 / 7	4	130	136	12	48	94	121	85
MVE 1500/6N-HF-38E	B	38	255	43	90	154	18	4	187	195	121	89	174	169	156
MVE 1300/6	C	50	321	58	120	170	17	4	208	210	22	94	180	205	170
VFV 100 25/6	D	08.0	410	74	150	190	17	4	280	258	30	117	227	260	212

ELECTRIC VIBRATORS FOR CONCRETE CONSOLIDATION - FOOT VERSION

APPLICATION Concrete compaction

FEATURES

DUTY CYCLE Continuous S1

MULTIVOLTAGE 3ph 42V - 3ph 230/400V [* voltage tolerance ± 10%]

FIXED FREQUENCY 50Hz and 200Hz

VARIABLE FREQUENCY 0÷100Hz

WORKING TEMPERATURE -10°C +40°C

MAX NOISE LEVEL 85 dB(A) at 1 meter distance

MATERIAL Cast aluminium or iron

FINISHING Painted: A, B, C: orange RAL 2009; D: blue RAL 5010, yellow RAL 1003

CERTIFICATIONS Community Directives and subsequent modifications: 2006/42/EC - 2006/95/EC
Conformity verified according to the standard documents IEC 60034

OPTIONS Power cable

ACCESSORIES Fixing brackets:
CLW (Clamp for Wooden formworks); CLS (Clamp for Steel formworks)



MVE 290/6 on CLW



Electric vibrators - CRADLE

E

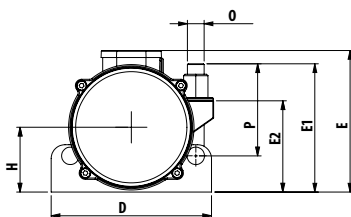
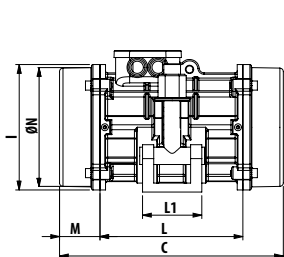

*Cradle not included

F

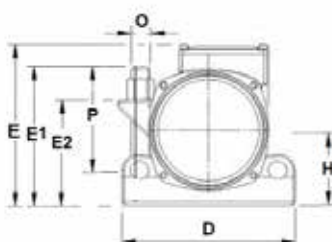
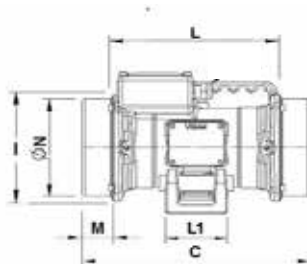

*Cradle not included

STANDARD FREQUENCY ELECTRIC MOTORS

Wm	MODEL	WEIGHT	CENTRIFUGAL FORCE	RPM	ELECTRICAL SPECIFICATIONS						CERTIFICATE	
					INPUT POWER	FREQUENCY	NOMINAL CURRENT A max.		POWER FACTOR	la / In		CABLE GLAND
kgcm		kg	kg		kW	Hz	42V	230/400V			Metric	Ex II3D
16	SPC 50 7.0 A-00	23.5	800	3,000	0.75	50	on request	2.25/1.30	0.84	5.0	M20	Temp. Class
20	SPC 50 9.0 A-00	24.5	1,000	3,000	0.85	50	on request	2.42/1.40	0.88	5.0	M20	on request

HIGH FREQUENCY ELECTRIC MOTORS

Wm	MODEL	WEIGHT	CENTRIFUGAL FORCE	RPM	ELECTRICAL SPECIFICATIONS						CERTIFICATE	
					INPUT POWER	FREQUENCY	NOMINAL CURRENT A max.		POWER FACTOR	la / In		CABLE GLAND
kgcm		kg	kg		kW	Hz	42V	230/400V			Metric	Ex II3D
7.40	HFC-200 6000/15	21.5	1,500	6,000	1.00	200	19.70	3.60/2.10	0.70	5.50	M20	on request
14.66	MVE 1300/6C	29.0	1,474	0÷6,000	1.30	0÷100	on request	4.24/2.44	0.77	3.10	M20	100° C
10.00	VFC 100 20/6	24.0	2,000	0÷6,000	1.25	0÷100	on request	4.00/2.30	0.79	5.50	M20	on request

DIMENSIONAL SPECIFICATIONS (mm)

MODEL	DRAWING	SIZE	C	M	L	L1	O	P	D	E	E1	E2	I	H	N
SPC 50 7.0 A-00	F	05	390	83	224	85	M24	132	230	212	184	136	163	95	148
SPC 50 9.0 A-00	F	05	390	83	224	85	M24	132	230	212	184	136	163	95	148
HFC-200 6000/15	F	05	312	44	224	85	M24	132	230	212	184	136	163	95	148
MVE 1300/6C	E	50	321	58	205	85	M24	132	230	203	184	131	180	93	170
VFC 100 20/6	F	05	390	83	224	85	M24	132	230	212	184	136	163	95	148

ELECTRIC VIBRATORS - CRADLE VERSION

APPLICATION Concrete compaction

FEATURES

DUTY CYCLE Continuous S1

MULTIVOLTAGE 3ph 42V - 3ph 230/400V [* voltage tolerance ± 10%]

FIXED FREQUENCY 50Hz and 200Hz

VARIABLE FREQUENCY 0÷100Hz

WORKING TEMPERATURE -10°C +40°C

MAX NOISE LEVEL 85 dB(A) at 1 meter distance

MATERIAL Cast aluminium or iron

FINISHING Painted: model E: orange RAL 2007, model D: blue RAL 5010, yellow RAL 1003

CERTIFICATIONS Community Directives and subsequent modifications: 2006/42/EC, 2006/95/EC

Conformity verified according to the standard document IEC 60034-1

OPTIONS Power cable

ACCESSORIES Fixing bracket: CRS (Cradle for Steel concrete moulds)

This information is furnished without warranty, representation, inducement or license of any kind. It is accurate to the best OLI knowledge or is obtained from sources believed to be accurate. OLI therefore assumes no legal responsibility.

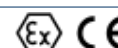



Fastening systems for external vibrators

▶ CLW - Clamp for Wooden formworks

CLW

APPLICATION	Quick mounting of vibrators on wooden formworks
SAFETY BELT	Included
FINISHING	Galvanized

SUITABLE FOR

DOKA	H20, Top50, FF20
PERI	VT20K, GT24, VARIO GT24
MEVA	H20
PASCAL	H20
NOE	H20
HÜNNEBECK	H20, R24, GF24, ES24



CLW DIMENSIONAL SPECIFICATION

MODEL	LENGTH mm	WIDTH mm	HEIGHT mm	WEIGHT kg	MULTIPLE FOOTPRINT (mm)			
					ELECTRIC	PNEUMATIC		
CLW 001	389	291	122	6	65x106	135x115	90x125	180

▶ CLS - Clamp for Steel formworks

CLS

APPLICATION	Quick mounting of vibrators on steel formworks
SAFETY CABLE	Included
FINISHING	Galvanized

SUITABLE FOR

DOKA	Framax XLife, Alu Framax XLife
PERI	Trio
MEVA	StarTec, Mammut
NOE	NOEtop



CLS DIMENSIONAL SPECIFICATION

MODEL	LENGTH mm	WIDTH mm	HEIGHT mm	WEIGHT kg	MULTIPLE FOOTPRINT (mm)			
					ELECTRIC	PNEUMATIC		
CLS 001	389	291	122	6.5	68x106	135x115	90x125	180

▶ CRS - Cradle for Steel concrete moulds

CRS

APPLICATION	Quick mounting of vibrators on formworks
FINISHING	Black painted

SUITABLE FOR

VIBRATING MOTOR	Electric and pneumatic
-----------------	------------------------



CRS DIMENSIONAL SPECIFICATIONS

MODEL	LENGTH	WIDTH	HEIGHT	RADIUS	WEIGHT
	mm	mm	mm	mm	kg
CRS 055	180	105	140	55	3.5
CRS 080	230	85	184	80	5



External pneumatic vibrators

The external pneumatic vibrators have **no electrical components**.

They are powered via **air compressor** that spins the rotors inside the vibrator at a very high speed (generally between 10,000 and 17,000 vpm), this generates a circular vibration that spreads in all directions.

The optimum frequency varies depending on the dimensions of the aggregates: a low frequency (approximately 10,000 vpm) favours the vibration of large granules (pebbles and gravel), while a high frequency (approximately 20,000 vpm) favours the vibration of fine granules (sand, cement and others).

They are used especially in the construction of concrete segments for tunnels, viaducts and bridges.

The pneumatic vibrators offered by OLI have a **solid and durable body** in ductile cast iron. They are characterised by **high reliability and efficiency** as well as by a **compact size**.

Just like the electric vibrators, they may also be bolted or attached via quick-coupling clamps to formworks or moulds for the purpose of easy movement.



Benefits

- Efficient and reliable
- No electric component
- No maintenance

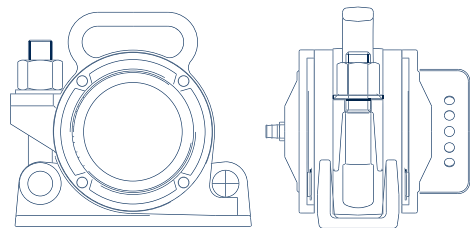

EASY HANDLE



Pneumatic vibrators

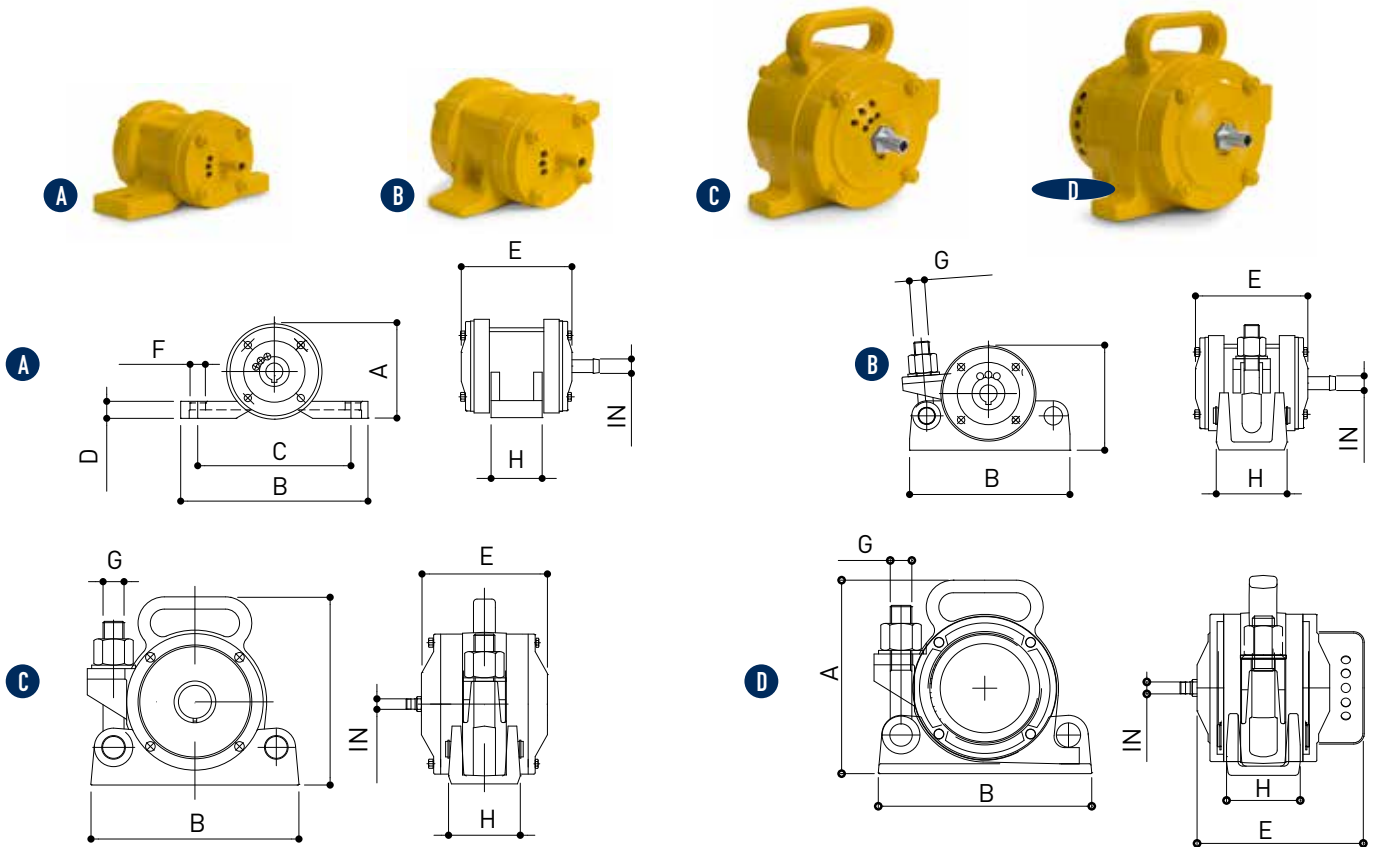

MODEL	WORKING PRESSURE bar	VIBRATION vpm	CENTR. FORCE kg	AIR CONSUMP. l/min	NOISE LEVEL dB (A)	OVERALL DIMENSIONS										
						DRAWING	A	B	C	D	E	F	G	H	IN	WEIGHT
							mm	mm	mm	mm	mm	mm	mm	mm	mm	mm
HFP 600P	6	17,000	720	1,000	100	A	111	220	180	20	164	20	-	60	15	6.3
HFP 1000P		16,500	1,122	1,100												7.2
HFP 1400P		16,000	1,453	1,200												7.3
HFP 600C	6	17,000	720	1,000	100	B	120	180	-	-	164	-	18	94	15	6.3
HFP 1000C		16,500	1,122	1,100												7.2
HFP 1400C		16,000	1,453	1,200												7.3
HFP 2700C		16,000	2,753	1,600	103	C	224	238	-	-	160	-	24	84	15	14
HFP 4000C		15,200	4,079	1,800												14.5
HFP 6000C		14,500	6,118	1,800												16.3
HFP 4001C*	6	10,200	4,079	1,800	90	D	215	240	-	-	180	-	24	84	15	18

PNEUMATIC VIBRATORS FOR CONCRETE CONSOLIDATION

APPLICATION Concrete formworks in situ
Concrete moulds in precast industry

FEATURES

WORKING PRESSURE 6 bar

AIR SUPPLY QUALITY Class 5.4.4

WORKING TEMPERATURE -10°C +60°C

MAX NOISE LEVEL 103 dB(A)
Silent version HFC 4001C: 90 dB(A) at 1 meter distance

TECHNOLOGY Eccentric rotor

MATERIALS Steel and cast iron

CERTIFICATIONS Conformity verified according to the standard document UNI EN ISO 12100

ACCESSORIES Fastening systems:
CLW (Clamp for Wooden formworks);
CLS (Clamp for Steel formworks);
CRS (Cradle for Steel concrete moulds)





Tips and recommendations for use

TIPS FOR CHOOSING THE EXTERNAL VIBRATOR

Selection of the vibrating head length

Must never exceed the thickness of the concrete layer.

Selection of the needle diameter

Factors involved when selecting a model:

- composition of the concrete
- quantity of reinforcements (percentage of reinforcement inside the article)
- size of the spaces existing between the various reinforcements (mesh sizes)
- thickness of the concrete layer

The diameter to be used must allow the guidance of the vibrator inside the reinforcement, without sticking out of and/or getting stuck in the mesh.

Definition of the operating tube length

Must be greater than the depth of the manufactured article in order to allow the vibration of deeper layers.

TIPS FOR CHOOSING THE INTERNAL VIBRATOR

Pneumatic or electric?

The selection depends on the type of power available (electricity grid or compressed air).

What type of fastening?

It depends on the construction material and the shape of the profiles to which the vibrators are to be fastened.

Definition of the positioning

Distribution of vibrators on the formwork.

Definition of the operating cycle

How many vibrators, running simultaneously, are needed.

Definition of the power (electric vibrators)

Electrical or electronic converter (with or without inverter).

MAIN RECOMMENDATIONS OF USE

Repeated vibration

It means vibrating again the already compacted concrete. This technique is used to mix successive layers of concrete in order to improve the surface finish quality of columns and walls and to increase their toughness and wear resistance.

Vibration inside the formwork

Make sure that the vibrating head does not touch the interior walls, because besides damaging them, it can generate depressions in the manufactured article, thus deteriorating the quality of the surfaces. Vibrators with rubber tips may be used for protection.

Insufficient vibration

It is the most common problem. Insufficient vibration can alter the structural properties, such as: lower resistance, higher abrasion, higher permeability, therefore shorter duration and worse surface quality.

Excessive vibration

The use of oversized equipment generates the segregation and subsequent detachment in time of dust and concrete chippings, in addition to the damages incurred to the formwork and moulds.

SOLID FOUNDATIONS

Since 1961 OLI has been committed to delivering market-oriented products. Specialising originally in immersion vibrators, in the late 1980s the company started the production of external electric and pneumatic vibrators. Today OLI is a global player in industrial vibration technology.



Choosing OLI means

PRODUCTS YOU CAN TRUST
Reliable. Efficient. Safe.

SERVICES YOU CAN COUNT ON
OLI's approach is based on consultancy, quick response and "ex-stock" delivery. Local competent and direct customer assistance is available worldwide, through the OLI Group's own subsidiaries.

WHEN YOU NEED IT, WHERE YOU NEED IT.

THE WORLDWIDE LEADER IN VIBRATION TECHNOLOGY

WWW.OLIVIBRA.COM



OLI Headquarters

Via Canalazzo, 35
41036 Medolla (MO) - Italy

+39 0535 41 06 11

info@olivibra.com

OLI worldwide

OLI Australia

OLI Benelux

OLI Brazil

OLI China

OLI France

OLI Germany

OLI India

OLI Italy

OLI Malta

OLI Middle East

OLI Nordic

OLI Romania

OLI Russia

OLI South Africa

OLI Spain

OLI Thailand

OLI Turkey

OLI UK

OLI USA