

Flanged vibrators



**SPECIFICALLY DESIGNED
FOR SIEVES AND INDUSTRIAL APPLICATIONS**

➔ **EASY TO SETUP**

Easy and intuitive to adjust the direction of the force

➔ **MAINTENANCE FREE**

Grease for life



MVE "S" - SIEVES SERIES

*Specifically designed and optimized
for circular sieve applications*

**SUPERIOR PERFORMANCE,
MORE FORCE & MORE EFFECTIVENESS**



MVE "I" - INDUSTRIAL SERIES

Developed for any industrial application

BUILT TO LAST



**VIBRATORS FOR
CIRCULAR VIBRATING
MACHINES AND
CIRCULAR SIEVES**



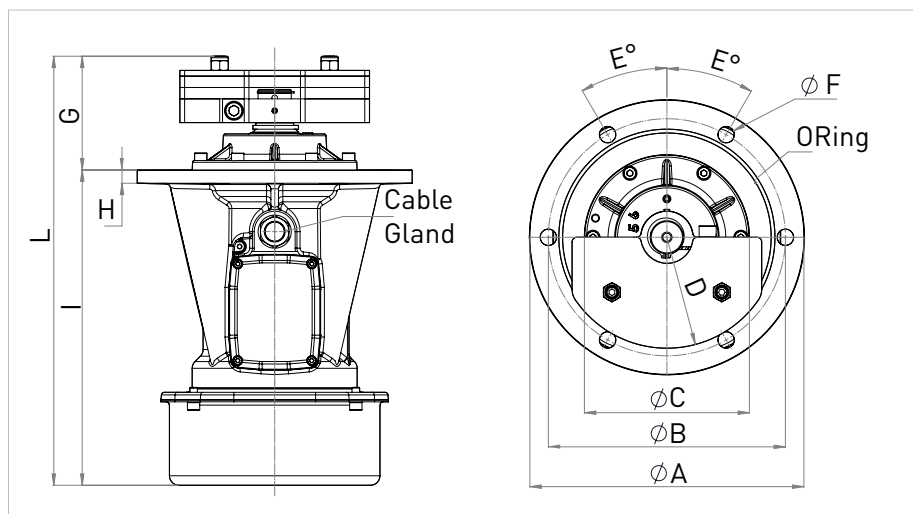

Wm (kgcm)		Model		Poles	Centrifugal Force (kg)		UP Centrifugal Force (kg)		DOWN Centrifugal Force (kg)		RPM		Weight (kg)		Input Power (kW)		Nominal Current A max. (Y)		Ia / In (Ampere)		Cable Gland
50Hz	60Hz	50Hz	60Hz	n°	50Hz	60Hz	50Hz	60Hz	50Hz	60Hz	50Hz	60Hz	50Hz	60Hz	50Hz	60Hz	50Hz (400V)	60Hz (460V)	50Hz	60Hz	Metric
9	6	MVE 500/3N-SL-40AD A	MVE 500/36N-SL-40AD A	2	463	456	362	355	101	101	3,000	3,600	16.2	15.7	0.5	0.58	1.0	1.0	3.5	3.5	M20
22	15	MVE 1100/3N-SL-50AE A	MVE 1100/36N-SL-50AE A	2	1,096	1,101	855	862	241	239	3,000	3,600	26.4	25.9	0.9	1.1	1.8	1.9	4.0	4.2	M20
29	20	MVE 1500/3N-SL-60AF A	MVE 1500/36N-SL-60AF A	2	1,468	1,477	1,227	1,231	241	246	3,000	3,600	43.0	41.0	1.5	1.6	2.9	2.6	5.2	5.0	M25
32	22	MVE 500/15N-SL-40AD A	MVE 500/18N-SL-40AD A	4	405	402	304	300	101	101	1,500	1,800	20.2	18.9	0.3	0.4	1.1	1.1	2.5	2.5	M20
62	43	MVE 800/15N-SL-50AE A	MVE 800/18N-SL-50AE A	4	774	775	596	601	178	174	1,500	1,800	30.3	28.3	0.6	0.8	1.4	1.3	3.8	3.8	M20
85	59	MVE 1100/15N-SL-50AF A	MVE 1100/18N-SL-50AF A	4	1,061	1,075	809.5	818	251	257	1,500	1,800	32.4	31.0	0.6	0.8	1.4	1.3	3.8	3.8	M20
85	59	MVE 1100/15N-SL-50AG A	MVE 1100/18N-SL-50AG A	4	1,061	1,075	809.5	818	251	257	1,500	1,800	32.4	31.0	0.6	0.8	1.4	1.3	3.8	3.8	M20
123	82	MVE 1500/15N-SL-60AF A	MVE 1500/18N-SL-60AF A	4	1,544	1,500	1,222	1,166	322	333	1,500	1,800	51.3	47.7	0.7	0.8	1.8	1.8	4.0	4.0	M25

Model		Size	DIMENSIONAL SPECIFICATIONS															
50Hz	60Hz		A	B	C	D	E	F	G (mm)		H	I	L (mm)		Holes	O Ring		
			mm	mm	mm	mm	degrees	mm	50Hz	60Hz	mm	mm	50Hz	60Hz				
MVE 500/3N-SL-40AD A	MVE 500/36N-SL-40AD A	40	232	205	150	73	30	13	45		12	256	301		6	4700		
MVE 1100/3N-SL-50AE A	MVE 1100/36N-SL-50AE A	50	260	230	168	93	30	15	79		24	298	377		6	4800		
MVE 1500/3N-SL-60AF A	MVE 1500/36N-SL-60AF A	60	290	250	174	93	30	17	103		14	333	435		6	4850		
MVE 500/15N-SL-40AD A	MVE 500/18N-SL-40AD A	40	232	205	150	78	30	13	80	70	12	256	336	326	6	4700		
MVE 800/15N-SL-50AE A	MVE 800/18N-SL-50AE A	50	260	230	168	98	30	15	104	98	24	298	402	396	6	4800		
MVE 1100/15N-SL-50AF A	MVE 1100/18N-SL-50AF A	50	290	250	168	117	30	17	98		24	298	396		6	4850		
MVE 1100/15N-SL-50AG A	MVE 1100/18N-SL-50AG A	50	290	254	168	117	45	15	98		24	298	396		4	4850		
MVE 1500/15N-SL-60AF A	MVE 1500/18N-SL-60AF A	60	290	250	174	117	30	17	130	110	14	333	463	443	6	4850		

FLANGED MOTOVIBRATOR MVE "S" SERIES

APPLICATION Circular vibrating sieves.

PROBLEM SOLVING Quick and easy installation and maintenance; grease for life.

FEATURES

INPUT VOLTAGE 400V (50Hz) or 460V (60Hz)

AMBIENT TEMPERATURE -20 °C / +40 °C

ENCLOSURE PROTECTION IP 66

THERMAL PROTECTION PTC Termistor 130 °C (above size 60)

INSULATION CLASS F

MVE "I" (INDUSTRIAL) SERIES

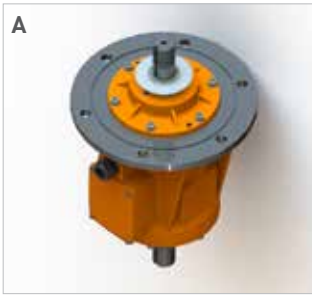
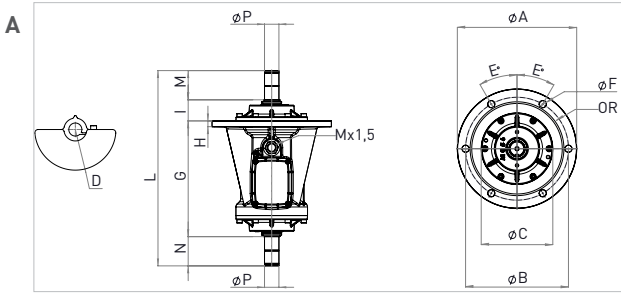

IL - LATERAL FLANGE

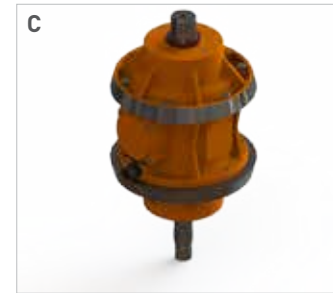
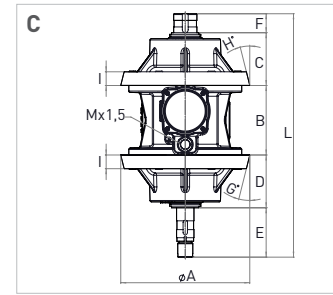

ID - DOUBLE FLANGE

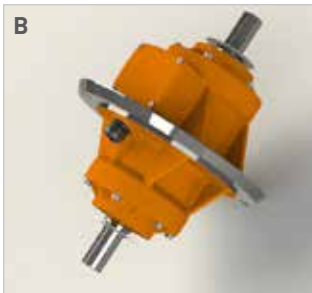
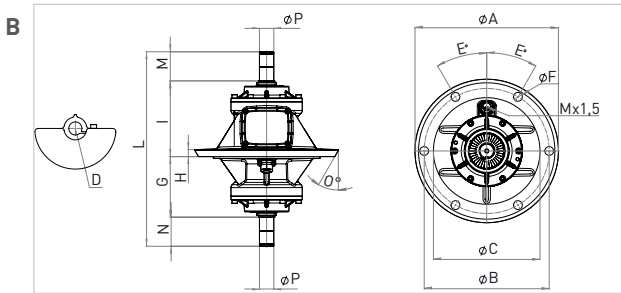

IC - CENTRAL FLANGE

Wm (kgcm)		Model		Poles	Centrifugal Force (kg)		UP Centrifugal Force (kg)		DOWN Centrifugal Force (kg)		RPM		Weight (kg)		ELECTRIC FEATURES						
50Hz	60Hz	50Hz	60Hz		50Hz	60Hz	50Hz	60Hz	50Hz	60Hz	50Hz	60Hz	50Hz	60Hz	50Hz	60Hz	50Hz	60Hz	50Hz	60Hz	Metric
18	14	MVE 250/15N-IL-30AB	MVE 250/18N-IL-30AB		4	226	253	113	126.5	113	126.5	1,500	1,800	12	11	0.1	0.1	0.5	0.5	2.0	2.0
140	107	MVE 2000/15N-IL-60AF	MVE 2000/18N-IL-60AF	4	1,760	1,933	880	967	880	967	1,500	1,800	53	50	1.1	1.3	2.2	2.1	4.9	4.9	M25
196	139	MVE 2500/15N-IL-70AM	MVE 2500/18N-IL-70AM	4	2,469	2,523	1,234	1,262	1,234	1,262	1,500	1,800	70	70	1.9	2.3	3.7	3.3	6.0	6.1	M25
294	196	MVE 3500/15N-IL-75AM	MVE 3500/18N-IL-75AM	4	3,695	3,555	1,848	1,777	1,848	1,777	1,500	1,800	102	93	2.5	3.0	4.5	4.6	6.5	6.6	M25
140	107	MVE 2000/15N-IC-60AM	MVE 2000/18N-IC-60AM	4	1,760	1,933	880	967	880	967	1,500	1,800	60	56	1.1	1.3	2.2	2.1	4.9	4.9	M25
196	139	MVE 2500/15N-IC-70AM	MVE 2500/18N-IC-70AM	4	2,469	2,523	1,234	1,262	1,234	1,262	1,500	1,800	72	72	1.9	2.3	3.7	3.3	6.0	6.1	M25
294	196	MVE 3500/15N-IC-75AX	MVE 3500/18N-IC-75AX	4	3,695	3,555	1,848	1,777	1,848	1,777	1,500	1,800	111	102	2.5	3.0	4.5	4.6	6.5	6.6	M25
199	139	MVE 2500/15N-ID-75	MVE 2500/18N-ID-75	4	2,500	2,500	1,250	1,250	1,250	1,250	1,500	1,800	66	66	2.5	3.0	4.5	4.6	6.5	6.6	M25

Model		Fig.	Size	DIMENSIONAL SPECIFICATIONS																Holes	O Ring
50Hz	60Hz			A	B	C	D	E	F	G	H	I	L	M	N	O	P				
MVE 250/15N-IL-30AB	MVE 250/18N-IL-30AB	A	30	215	188	118	61	45	13	64	12	240	304	--	--	--	17	4	4625		
MVE 2000/15N-IL-60AF	MVE 2000/18N-IL-60AF	A	60	290	250	174	105	30	17	281	14	51	475	71	71	--	35	6	4850		
MVE 2500/15N-IL-70AM	MVE 2500/18N-IL-70AM	A	70	350	305	200	125	30	22	298	18	55	523	85	85	--	40	6	41050		
MVE 3500/15N-IL-75AM	MVE 3500/18N-IL-75AM	A	75	350	305	225	125	30	22	326	20	66	562	85	85	--	40	6	41050		
MVE 2000/15N-IC-60AM	MVE 2000/18N-IC-60AM	B	60	350	305	260	105	30	22	148	17	185	475	71	71	30	35	6	--		
MVE 2500/15N-IC-70AM	MVE 2500/18N-IC-70AM	B	70	350	305	260	125	30	21	158	21	195	523	85	85	30	40	6	--		
MVE 3500/15N-IC-75AX	MVE 3500/18N-IC-75AX	B	75	400	355	310	125	30	24	186	22	206	562	85	85	15	40	6	--		
MVE 2500/15N-ID-75	MVE 2500/18N-ID-75	C	75	282	152	131	116	108	42	14°	14°	30	548	--	--	--	--	--	--		

FLANGED MOTOVIBRATOR MVE "I" SERIES (IL, IC, ID)

APPLICATION Circular vibrating machines. circular vibrating sieves.

PROBLEM SOLVING Quick and easy installation and maintenance; grease for life.

FEATURES

INPUT VOLTAGE 400V (50Hz) or 460V (60Hz)

AMBIENT TEMPERATURE -20 °C / +40 °C

ENCLOSURE PROTECTION IP 66

THERMAL PROTECTION PTC Termistor 130 °C (above size 60)

INSULATION CLASS F

The product code system follows the scheme below:

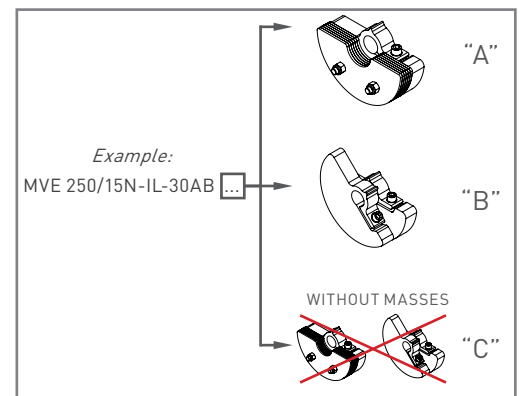

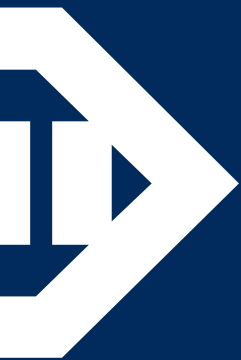

WHEN YOU NEED IT. WHERE YOU NEED IT

THE WORLDWIDE LEADER IN VIBRATION TECHNOLOGY



OLI WORLDWIDE

OLI Australia	OLI Germany	OLI Nordic	OLI Turkey
OLI Benelux	OLI India	OLI Russia	OLI UK
OLI Brazil	OLI Italy	OLI South Africa	OLI USA
OLI China	OLI Malta	OLI Spain	
OLI France	OLI Middle East	OLI Thailand	



OLI Headquarters

Via Canalazzo, 35
41036 Medolla (MO) - Italy

+39 0535 41 06 11

info@olivibra.com

WWW.OLIVIBRA.COM

