

Rawal Scientific Glass Works

<https://www.indiamart.com/rawalscientificglass-works/>

Established as a **Proprietor** firm in the year **2003**, we “**Rawal Scientific Glass Works**” are a leading **Manufacturer, Wholesaler and Trader** of a wide range of **Lab Equipment, Glass Flask, Conical Flask, ...**



About Us

For more information, please visit

<https://www.indiamart.com/rawalscientificglass-works/profile.html>





Volumetric Or Measuring Flask



Laboratory Glassware Flask

FLASK

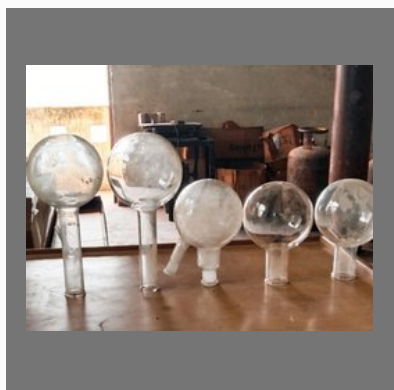

round bottom flask



conical flaks



Tubes Culture Media Round Bottom



1000ml kjeldhal Flask

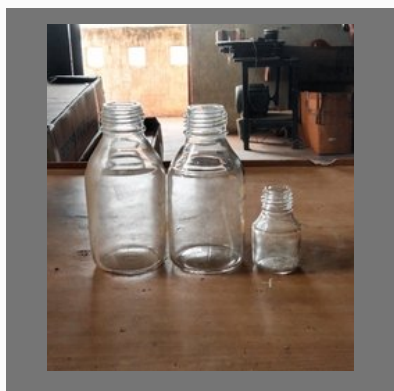

reagent bottle



Glass Weighing Scoops



Calcium Chloride Tube



Culture Tube Without Cap

TUBE



centrifuge tube with stopper



Leighton Tube

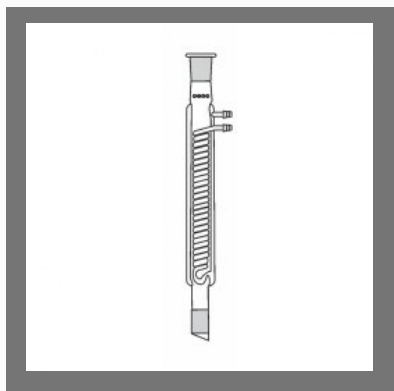

Jacketed Coil Condenser



Ether Condenser

GLASS



Friedrich Condensers



double surface condenser
globular extraction

FUNNELS

SEPARATORS



Seprating Funnel

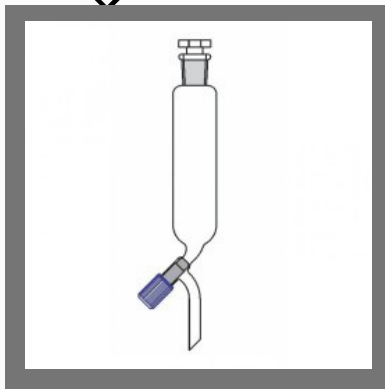

Dropping Funnel Ptfе Key



dropping funnel with stopcock

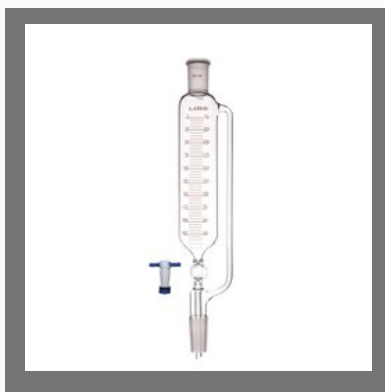

dropping funnel with ptfe



Soxhlet Extractor



Spare Extractor

EXTRA

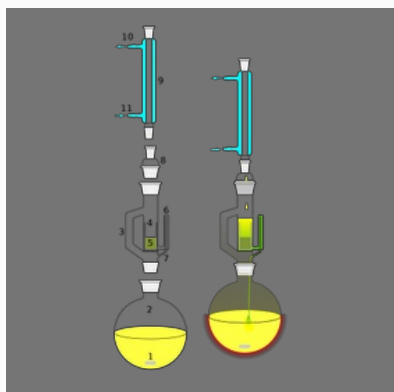

soxhlet extraction apparatus



weighing bottle tall from cap type



Weighing Bottle

WEIGH



weighing bottle



Lab Adapter Receiver Straight Socket to Rubber



expansion adapter

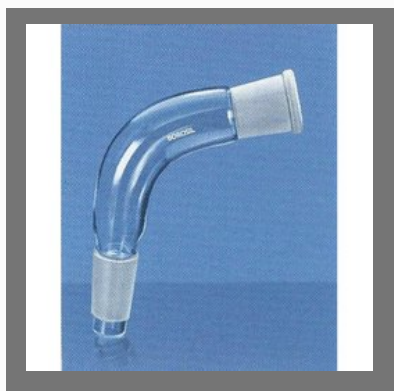

Lab Adapter Receiver With Straight Plain Bend

LABOR

NEW



dripping funnel separator



Reagent bottle



Buchi Flask



separating funnel



volumetric or measuring flask

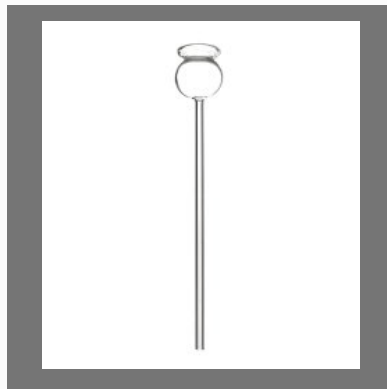

Thistle Funnel

OTHER



culture tube with screw cap



Liebig Condensers



Laboratory Separating Funnel



Glass Separating Funnel

OTHER



200ml Reagent Bottles



Borosilicate Glass Reagent Bottle



vigreux claisen flask



Specific Gravity Bottle

OTHER



separating funnel

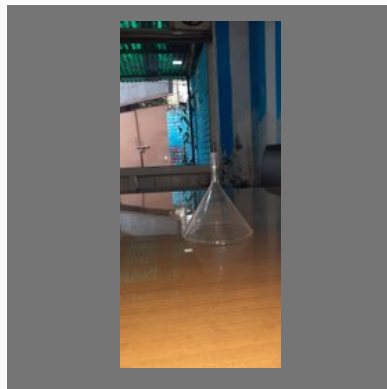

Borosilicate Glassware Steam Funnel

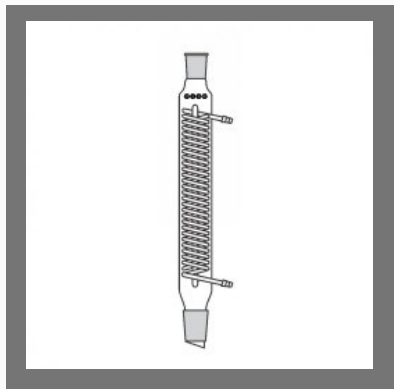

Double Coil Condenser

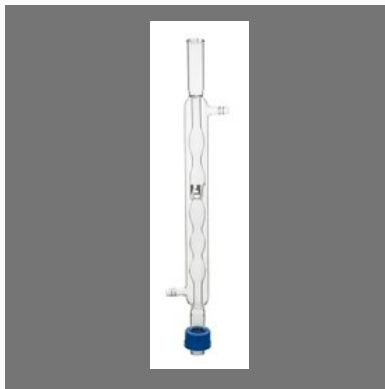

Bulb Condensers

OTHER



dufton fractionating columns



Chromatography Coloumns

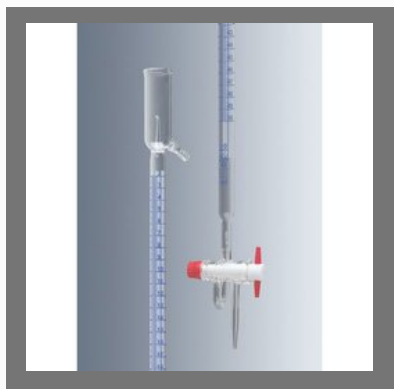

Laboratory Burette

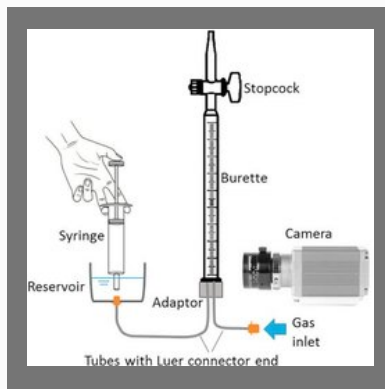

Gas Measuring Burette



Measuring Cylinder

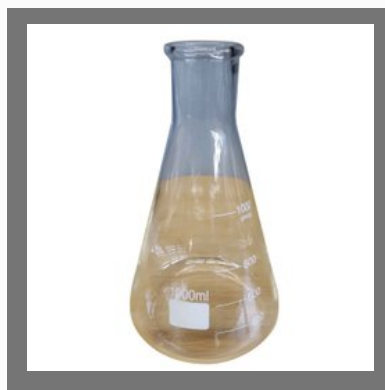

Borosilicate Glass Conical Flask

OTHER



separating funnel with ptfe stopcock



gass wash bottel

OTHER



Glass Beakers



filtration flask



Buchner flask with sintered disk



water glass



boro 3.3 Petri dish



Gas Collecting Tube

OTHER



long stem funnel



Measuring Glass With Stopper



distillation flask



Serological Pipette

OTHER



laboratory crystallizing dish

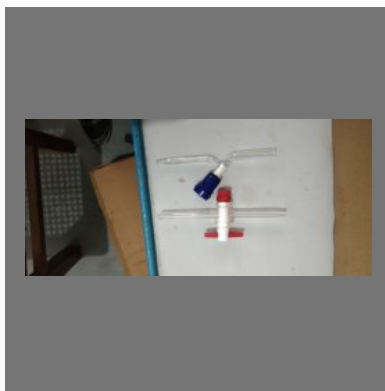

burette stopcock



Lab Adapters Receiver Bend With Vent



Reagent bottle

OTHER

Factsheet

Year of Establishment : 2003

Nature of Business : Manufacturer

Total Number of Employees : Upto 10 People



Rawal Scientific Glass Works

Contact Person: Himanshu Rawal

9, Pooja Vihar, Behind Pooja Filling Station Ambala Cantt
Ambala - 133001, Haryana, India



+91-8046068448



<https://www.indiamart.com/rawalscientificglass-works/>

CONTACT US

