



2016  
2017  
/

# BIKES ROLL BETTER



## Company

The hub is important because it is the main weight-bearing component of the bike. The weight of bicycle and the rider, with all the rolling forces, bear down on the hubs. Amid today's varied and demanding bicycle-performance requirements. Bitex makes a wide range of bicycle hubs that offer :

- Superior strength & stiffness
- Longest lasting durability & reliability
- Lightest weight
- Smoothest rolling performance
- Best value
- Finest finishing colors

**BITEX INDUSTRIAL CO. LTD**  
[www.biteshubs.com](http://www.biteshubs.com)



This is the revolution to make the hubs-unique in the world  
Good quality / Best Service / Customers satisfaction

## INDEX

		01	
		/	
		INDEX	
HISTORY	_____	02	
ANTI-BITE SYSTEM FREEHUB BODY	_____	03	
BITEX 6 PAWLS FREEHUB BODY	_____	04	
FREEHUB BODY	<b>ROAD - 48HD FOR ROAD -</b> TITANIUM SHIMANO 11s ALLOY SHIMANO 10s/11s ALLOY CAMPY 11s	<b>MTB - 54HD FOR MTB -</b> TITANIUM SHIMANO 11s ALLOY SRAM XX1 6 PAWLS WORKING TOGETHER STEEL SHIMANO 11s ALLOY SHIMANO 10s/11s	05
ROAD BIKE HUBS	<b>ROAD HUBS</b> BX307F · BX307R _____ BX306F · BX306FG · BX306R _____ BX303F · BX303R / BX305F · BX305R _____ BX301F · BX301R / RSPF · RSPR _____ RAF10 · RAR9 / RAF12 · RAR12 / RAF16 · RAR16 _____	06 07 08 09 10	
	<b>CENTERLOCK</b> BX106F · BX106R _____	11	
	<b>CYCLO CROSS HUBS</b> BX201F · BX201R	} _____ 12	
	<b>TOURING BIKE</b> BX101F · BX101R · BX103R		
	<b>FOLDING HUBS</b> RAF8 · RAR8 / A702SB _____	13	
MTB HUBS	<b>BOOST HUBS</b> BX210F · BX210R _____	14	
	<b>MTB HUBS</b> BX401F · BX401R _____ MTF15/20 · MTR12 / MTR12-150 _____ BX207F · BX207R / BX601F _____ MTF10 · MTR10 / A20M _____	15 16 17 18	
	<b>FAT BIKE HUBS</b> FB-MTF15/20 _____ FB-MTR12(170/177/190/197mm) _____	20 21	
TRACK HUBS	TKF10 · TKR10 _____	22	
TRIKE / RECUMBENT BIKE	DH12N · DH12M · DH15M · DH20M	} _____ 23	
WHEEL CHAIR HUBS	DH12.7N / DH12.7 AXLE		
SKEWER	SK-MD01 · SK-MD02 · SK-MS01 _____ SK-NO8 · SK-MF46 · SK-R12 _____	24 25	
ENTRY PRODUCTS	A701F · A703R / CL100R · CS300R / A781F _____ DS200F · DS200R / DL200F · DL200R / DL802F · DL803R _____ A771F · A773R / A802F · A803R / A702SQ · A702F _____ A802F · A802R / A771F · A772R / A783SB _____	26 27 28 29	

# | HISTORY |



2015

Titanium Freehub Body

2014

54HD MTB Freehub Body



2010

Six Pawls Patented Design



1978

Bitex Industrial Co., Ltd.

1947

Company Name : Valisum Industrial CO., Ltd.  
The first company to develop coaster hub.

1923

Name of shop : Valisum Bike Shop  
The first to offer : Rickshaw(1935)/Tricycle(1948)



# | ANTI-BITE SYSTEM FREEHUB BODY |



- Taiwan | M519075
- China | ZL 2015 2 0925200.8
- Germany | Nr. 20 2015 106 474



## Innovative technology

One of the most common complaints about Alloy freehub bodies is how easily they can be gouged by cassettes, leaving ugly notches that make removing the cassette difficult. Introducing the new Bitex “Anti-Bite System” - three small, hardened stainless splines to our patented 6-pawl freehub body that will absorb the pressure of the steel cassette. Customers asked for a solution to freehub gouging, and we’ve delivered it.

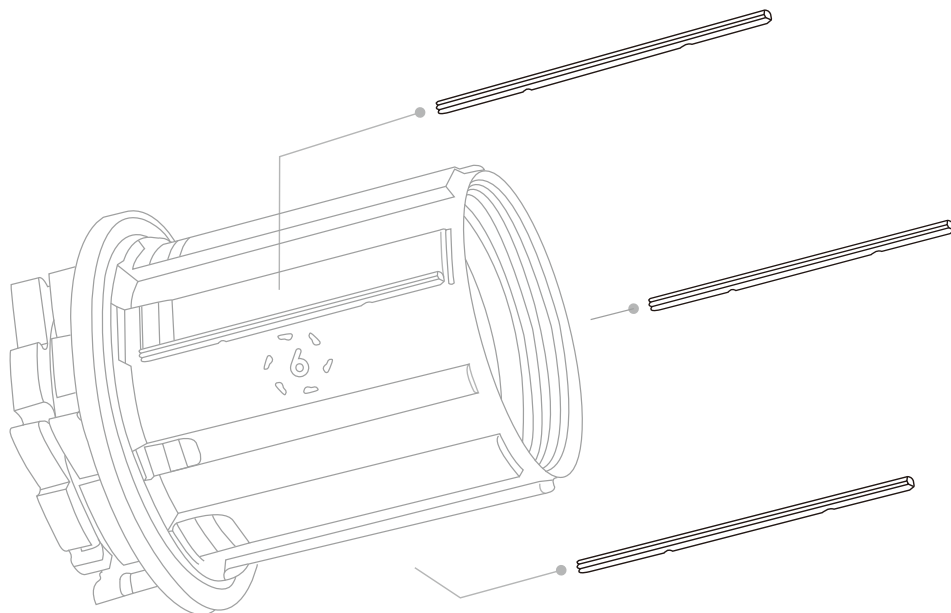

# | BITEX 6 PAWLS FREEHUB BODY |



Taiwan  
China  
Germany  
USA

M425782  
ZL 2011 2 04061190  
Nr. 20 2011 051 875.2  
US 8,443,951 B1

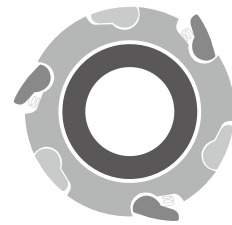

**A team**

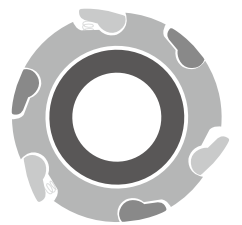

**B team**

## How it works

New and improved design.

Two sets of three pawls - six in total - reduction in distance between points of engagement by 50%.



## Feature

1 / Lighter

2 / Durable : total 6 pawls, 3 pawls one turn, 2 turns work.

3 / Smooth : 54HD for MTB , 48HD for ROAD , high transmission efficiency.

4 / Easy to replace.

5 / The price depends on the bearings.

6 / Bearing options : Steel / Ceramic / Stainless Steel

# | FREEHUB BODY |

MTB

54HD FOR MTB



R07-G2C2  
**Titanium Shimano 11s**  
 Weight : 111g  
 Material : Titanium  
 Bearings : 3 (6802\*2+6902\*1)



R07-D2C2  
**Alloy SRAM XX1**  
 Weight : 73.4g  
 Material : Alloy  
 Bearings : 2 (6802\*1+6902\*1)



R07-M2C2Z  
**Alloy Shimano 10 / 11s**  
**6 pawls working together**  
**For MTB Heavy Duty**  
 Weight : 79.9g  
 Material : Alloy  
 Bearings : 2 (6802\*1+6902\*1)



R07-K2A2  
**Steel Shimano 11s**  
**For BX103R**  
**Heavy Duty**  
 Weight : 153.8g  
 Material : Steel  
 Bearings : 3 (6802\*2+6902\*1)

MTB

ROAD

48HD FOR ROAD



R07-M2C2  
**Alloy Shimano 10 / 11s**  
 Weight : 80g  
 Material : Alloy  
 Bearings : 2 (6802\*1+6902\*1)



R07-F2C1  
**Titanium Shimano 11s**  
 Weight : 106.9g  
 Material : Titanium  
 Bearings : 3 (6802\*2+6902\*1)



R07-B2C1  
**Alloy Shimano 10/11s**  
 Weight : 77.2g  
 Material : Alloy  
 Bearings : 2 (6802\*1+6902\*1)



R07-C2C1B  
**Alloy Campy 11s**  
 Weight : 73.9g  
 Material : Alloy  
 Bearings : 2 (6802\*2)

# | ROAD BIKE HUBS |



**BX307F** 95g

Bearings :  $\odot$  2 (699\*2)

Gauge : 14

Holes : 16 , 18 , 20

Axle option : M9(QR)\*100mm

P.C.D :  $\varnothing$ 34



**BX307R** 260g

Bearings :  $\odot$  4 (6802\*2+6902\*2)

Gauge : 14

Holes : 8/16

Axle option : M10(QR)\*130mm

P.C.D :  $\varnothing$ 42 -  $\varnothing$ 68



# | ROAD BIKE HUBS |



**BX306F** 99g

Bearings :  $\odot$  2 (699\*2)  
Gauge : 14  
Holes : 20 , 24  
Axle option : M9(QR)\*100mm  
P.C.D :  $\varnothing$ 32



**BX306FG** 110g

Bearings :  $\odot$  2 (6803\*2)  
Gauge : 14  
Holes : 20 , 24  
Axle option : 12M\*100mm  
15M\*100mm  
P.C.D :  $\varnothing$ 36



**BX306R** 231.4g

Bearings :  $\odot$  4 (6802\*2+6902\*2)  
Gauge : 14  
Holes : 8/16 , 24  
Axle option : M10(QR)\*135mm  
10M\*135mm      \*Free Hub Body Compatible for  
12M\*135mm      - Shimano 10 / 11s  
12M\*142mm      - Campy  
P.C.D :  $\varnothing$ 35 -  $\varnothing$ 49

# | ROAD BIKE HUBS |



**BX303F** 75.2g

Bearings :  $\odot$  2 (699\*2)  
Gauge : 14  
Holes : 18 , 20 , 24  
Axle option : M9(QR)\*100mm  
P.C.D :  $\varnothing$ 28



**BX303R** 225g

Bearings :  $\odot$  4 (6802\*2+6902\*2)  
Gauge : 14  
Holes : 7/14 , 8/16 , 24 , 28  
Axle option : M10(QR)\*130mm  
P.C.D :  $\varnothing$ 30 -  $\varnothing$ 52.5  
\*Free Hub Body Compatible for  
- Shimano 10 / 11s  
- Campy



**BX305F** 66.5g

Bearings :  $\odot$  2 (699\*2)  
Gauge : 14  
Holes : 20 , 24  
Axle option : M9(QR)\*100mm  
P.C.D :  $\varnothing$ 28



**BX305R** 204g

Bearings :  $\odot$  4 (6802\*2+6902\*2)  
Gauge : 14  
Holes : 8/16 , 24  
Axle option : M10(QR)\*130mm  
M10(QR)\*135mm  
P.C.D :  $\varnothing$ 35 -  $\varnothing$ 49  
\*Free Hub Body Compatible for  
- Shimano 10 / 11s  
- Campy

# | ROAD BIKE HUBS |



**BX301F** 97g

Bearings :  $\odot$  2 (6900\*2)  
Gauge : 14  
Holes : 18 , 20 , 24  
Axle option : M9(QR)\*100mm  
P.C.D :  $\varnothing$ 30.3



**BX301R** 227g

Bearings :  $\odot$  4 (6802\*2+6902\*2)  
Gauge : 14  
Holes : 7/14 , 8/16 , 24 , 28  
Axle option : M10(QR)\*130mm  
P.C.D :  $\varnothing$ 32 -  $\varnothing$ 52.5

\*Free Hub Body Compatible for  
- Shimano 10 / 11s  
- Campy



**RSPF** 106.5g

Bearings :  $\odot$  2 (6900\*2)  
Gauge : 14  
Holes : 16 , 18 , 20 , 24  
Axle option : M9(QR)\*100mm  
P.C.D :  $\varnothing$ 30.3



**RSPR** 210g

Bearings :  $\odot$  4 (6802\*2+6902\*2)  
Gauge : 14  
Holes : 7/14 , 8/16 , 24 , 28  
Axle : M10(QR)\*130mm  
P.C.D :  $\varnothing$ 32 -  $\varnothing$ 52.5

\*Free Hub Body Compatible for  
- Shimano 10 / 11s  
- Campy

# ROAD BIKE HUBS



**RAF10** 66g

Bearings :  $\odot$  4 (688\*4)  
Gauge : 14  
Holes : 16 , 18 , 20  
Axle option : M9(QR)\*100mm  
P.C.D :  $\varnothing$ 30



**RAF12** 86g

Bearings :  $\odot$  2 (6900\*2)  
Gauge : 14  
Holes : 20 , 24 , 28 , 32  
Axle option : M9(QR)\*100mm  
P.C.D :  $\varnothing$ 32



**RAF16** 116.5g

Bearings :  $\odot$  2 (6000\*2)  
Gauge : 14  
Holes : 24 , 28 , 32 , 36  
Axle option : M9(QR)\*100mm  
P.C.D :  $\varnothing$ 35.5



**RAR9** 191g/192g (w/11s)

Bearings :  $\odot$  4 (6802\*4)  
Gauge : 14  
Holes : 7/14 , 8/16 , 20 , 24  
Axle option : M10(QR)\*130mm  
M10(QR)\*135mm  
P.C.D :  $\varnothing$ 38.5 -  $\varnothing$ 50.6  
\*Free Hub Body Compatible for  
- Shimano 10 / 11s  
- Campy



**RAR12** 215g

Bearings :  $\odot$  4 (6802\*2+6902\*2)  
Gauge : 14  
Holes : 7/14 , 8/16 , 24 , 28 , 32  
Axle option : M10(QR)\*130mm  
M10(QR)\*135mm  
P.C.D :  $\varnothing$ 38.5 -  $\varnothing$ 50.6  
\*Free Hub Body Compatible for  
- Shimano 10 / 11s  
- Campy



**RAR16** 222.5g

Bearings :  $\odot$  4 (6802\*2+ 6902\*2)  
Gauge : 14  
Holes : 24 , 28 , 32  
Axle option : M10(QR)\*130mm  
M10(QR)\*135mm  
P.C.D :  $\varnothing$ 50.6  
\*Free Hub Body Compatible for  
- Shimano 10 / 11s  
- Campy

# | CENTERLOCK |

ROAD BIKE HUBS



## BX106F 125g

Bearings :  $\odot$  2 (6902\*2)

Gauge : 14

Holes : 24 , 28 , 32

Axle option : 12M\*100mm  
15M\*100mm

P.C.D :  $\varnothing$ 45



## BX106R 230g

Bearings :  $\odot$  4 (6902\*3+6802\*1)

Gauge : 14

Holes : 24 , 28 , 32

Axle option : M10(QR)\*135mm  
12M\*135mm  
12M\*142mm

P.C.D :  $\varnothing$ 45 -  $\varnothing$ 50.6

\*Free Hub Body Compatible for

- Shimano 10 / 11s

- Campy

# | CYCLO CROSS HUBS |

ROAD BIKE HUBS



**BX201F** 133g

Bearings :  $\odot$  2 (6802\*2)  
 Gauge : 14  
 Holes : 20 , 24  
 Axle option : M9(QR)\*100mm  
 12M\*100mm  
 P.C.D :  $\varnothing$ 58 -  $\varnothing$ 45



**4 IN 1**

**BX201R** 286g

Axle option  
 - M10(QR)\*135mm  
 - 10mm\*135mm  
 - 12mm\*135mm  
 - 12mm\*142mm

Bearings :  $\odot$  4 (6902\*3+6802\*1)  
 Gauge : 14  
 Holes : 24 , 28  
 P.C.D :  $\varnothing$ 58  
 Casstte : Aluminum or Steel  
 \*Free Hub Body Compatible for  
 - Shimano system : 10 / 11s  
 - SRAM system : XX1

# | TOURING BIKE |



**5 IN 1**

**BX101F** 163g

End Cap Option  
 - M9(QR)\*100mm  
 - 9M\*100mm  
 - 12M\*100mm  
 - 15M\*100mm  
 - 20M\*110mm

Bearings :  $\odot$  2 (6804\*2)  
 Gauge : 14  
 Holes : 28 , 32 , 36  
 P.C.D :  $\varnothing$ 45



**BX101R** 255g

Bearings :  $\odot$  4 (6902\*3+6802\*1)  
 Gauge : 14  
 Holes : 28 , 32 , 36 , 40  
 Axle option : M10(QR)\*130mm  
 10M\*130mm  
 12M\*130mm  
 10M\*135mm  
 12M\*135mm

P.C.D :  $\varnothing$ 58  
 - W/6 Pawls alloy freehub body -  
 (2 Bearings 6902\*1+6802\*1)



**BX103R** 339.6g

Bearings :  $\odot$  6 (6902\*4+6802\*2)  
 Gauge : 14  
 Holes : 32 , 36 , 40  
 Axle option : M10\*130mm  
 M10\*135mm  
 12M\*130mm  
 P.C.D :  $\varnothing$ 58  
 - W/6 Pawls steel freehub body -  
 (3 Bearings 6802\*2+6902\*1)

# FOLDING HUBS

ROAD BIKE HUBS



**RAF8** 65g

Bearings :  $\odot$  2 (699\*2)  
Gauge : 14  
Holes : 16 , 18 , 20 , 24  
Axle option : M9(QR)\*74mm  
                  M9(QR)\*85mm  
                  M9(QR)\*100mm  
P.C.D :  $\varnothing$ 30



**RAR8** 185g

Bearings :  $\odot$  4 (6802\*3+6902\*1)  
Gauge : 14  
Holes : 7/14 , 8/16 , 24 , 28  
Axle option : M10(QR)\*120mm  
                  M10(QR)\*130mm  
P.C.D :  $\varnothing$ 38.5 - 50.6  
\*Free Hub Body Compatible for  
- Shimano : 10 / 11s  
- Campy



**A702SB** 151g

Bearings :  $\odot$  2 (6000\*2)  
Gauge : 14  
Holes : 20 , 24 , 28 , 32  
Axle option : M9(QR)\*76mm  
                  M9(QR)\*88mm  
                  M9(QR)\*100mm  
P.C.D : 2.5mm -  $\varnothing$ 35  
          2.7mm -  $\varnothing$ 35.5

| BOOST HUBS |  
MTB HUBS



BX210F 180g

Bearings :  $\odot$  2 (6804\*2)

Gauge : 14

Holes : 32

Axle option : 15M\*110mm

P.C.D :  $\varnothing$ 58 -  $\varnothing$ 45



BX210R 335g

Bearings :  $\odot$  4 (6902\*3+6802\*1)

Gauge : 14

Holes : 32

Axle option : 12M\*148mm

P.C.D :  $\varnothing$ 58

\*Free Hub Body Compatible for

- Shimano 10 / 11s

- SRAM XX1(XD)

Skewer : Sram(w/o. Nut).12M\*180B(OLD:148mm)

Skewer : Shimano(w/Nut).12M\*178B(OLD:148mm)



# | MTB HUBS |

**5 IN 1**

End Cap Option

- M9(QR)\*100mm
- 9M\*100mm
- 12M\*100mm
- 15M\*100mm
- 20M\*110mm



Item

- BX401F
- MTF15/20
- BX207F
- BX101F

**4 IN 1**

Axle option

- M10(QR)\*135mm
- 10mm\*135mm
- 12mm\*135mm
- 12mm\*142mm



Item

- BX401R
- MTR12
- MTR10
- BX207R
- BX201R



**5 IN 1**

**BX401F** 183g(28H)

Bearings :  $\odot$  2 (6804\*2)

Gauge : 14

Holes : 24 , 28 , 32

P.C.D :  $\varnothing$ 51



**4 IN 1**

**BX401R** 275g(28H)

Bearings :  $\odot$  4 (6902\*3+6802\*1)

Gauge : 14

Holes : 24 , 28 , 32

P.C.D :  $\varnothing$ 51

\*Free Hub Body Compatible for

- Shimano 10 / 11s

- SRAM XX1(XD)

Skewer:Shimano(w/Nut). 12M\*172B(OLD:142mm)

Skewer:Sram(w/o. Nut). 12M\*174B(OLD:142mm)

# | MTB HUBS |



**5 IN 1**

**MTF 15/20** 185g

End Cap Option

- M9(QR)\*100mm
- 9M\*100mm
- 12M\*100mm
- 15M\*100mm
- 20M\*110mm

Bearings :  $\odot$  2 (6804\*2)  
Gauge : 14  
Holes : 24 , 28 , 32  
P.C.D :  $\varnothing$ 58 -  $\varnothing$ 45



**4 IN 1**

**MTR 12** 290g

Axle option

- M10(QR)\*135mm
- 10mm\*135mm
- 12mm\*135mm
- 12mm\*142mm

Bearings :  $\odot$  4 (6902\*3+6802\*1)  
Gauge : 14  
Holes : 24 , 28 , 32  
P.C.D :  $\varnothing$ 58

\*Free Hub Body Compatible for  
- Shimano 10 / 11s  
- SRAM XX1



**MTR 12-150(12M\*150mm)** 306g

Bearings :  $\odot$  4 (6902\*3+6802\*1)  
Gauge : 14  
Holes : 28 , 32  
Axle option : M10(QR)\*150mm  
10M\*150mm  
12M\*150mm

P.C.D :  $\varnothing$ 58

\*Free Hub Body Compatible for  
- Shimano 10 / 11s  
- SRAM XX1(XD)

# | MTB HUBS |



Lefty Hub

**BX601F** 124.5g

Bearings :  $\odot$  2 (6805\*1+6902\*1)

Gauge : 14

Holes : 28 , 32

P.C.D :  $\varnothing$ 58 -  $\varnothing$ 45



**5 IN 1**

**BX207F** 215g

Bearings :  $\odot$  4 (6804\*4)

Gauge : 14

Holes : 24 , 28 , 32

P.C.D :  $\varnothing$ 58 -  $\varnothing$ 45

- End Cap Option
- M9(QR)\*100mm
  - 9M\*100mm
  - 12M\*100mm
  - 15M\*100mm
  - 20M\*110mm



**4 IN 1**

**BX207R** 380g

Bearings :  $\odot$  6 (6902\*4+6802\*2)

Gauge : 14

Holes : 24 , 28 , 32

P.C.D :  $\varnothing$ 58

- \*Free Hub Body Compatible for
- Shimano 10 / 11s
  - SRAM XX1(XD)

- Axle option
- M10(QR)\*135mm
  - 10mm\*135mm
  - 12mm\*135mm
  - 12mm\*142mm

# | MTB HUBS |



**MTF10** 173.5g

Bearings :  $\odot$  2 (6902\*2)  
Gauge : 14  
Holes : 24 , 28 , 32 , 36  
Axle option : M10(QR)\*100mm  
P.C.D :  $\varnothing$ 58



**MTR10** 287g

Axle option  
- M10(QR)\*135mm  
- 10mm\*135mm  
- 12mm\*135mm  
- 12mm\*142mm

Bearings :  $\odot$  4 (6902\*3+6802\*1)  
Gauge : 14  
Holes : 24 , 28 , 32 , 36  
P.C.D :  $\varnothing$ 58  
Cassette : Aluminum or Steel  
\*Free Hub Body Compatible for  
- Shimano : 10 / 11s  
- SRAM : XX1



**A20M** 251.5g

Bearings :  $\odot$  2 (6805\*2)  
Gauge : 14  
Holes : 24 , 28 , 32 , 36  
ID : 20mm  
P.C.D :  $\varnothing$ 58

| FAT BIKE HUBS |  
MTB HUBS



FB-MTF15/20 245.7g(135mm)

- End Cap Option
- M9(QR)\*135mm
  - 12M\*135mm
  - 15M\*135mm

Bearings : ◎ 2 (6804\*2)  
Gauge : 14  
Holes : 32 , 36  
P.C.D : Ø58



FB-MTF15/20 264.9g(150mm)

- End Cap Option
- M9(QR)\*150mm
  - 12M\*150mm
  - 15M\*150mm

Bearings : ◎ 2 (6804\*2)  
Gauge : 14  
Holes : 32 , 36  
P.C.D : Ø58

# | FAT BIKE HUBS |

MTB HUBS



**FB-MTR12** 323.9g(170mm)

Bearings :  $\odot$  4 (6902\*3+6802\*1)

Gauge : 14

Holes : 32 , 36

Axle option : M10(QR)\*170mm

M10(QR)\*177mm

12M\*170mm

12M\*177mm

P.C.D :  $\varnothing$ 58

\*Free Hub Body Compatible for

- Shimano 10 / 11s

- SRAM XX1



**FB-MTR12** 340.3g(190mm)

Bearings :  $\odot$  4 (6902\*3+6802\*1)

Gauge : 14

Holes : 32 , 36

Axle option : M10(QR)\*190mm

M10(QR)\*197mm

12M\*190mm

12M\*197mm

P.C.D :  $\varnothing$ 58

\*Free Hub Body Compatible for

- Shimano 10 / 11s

- SRAM XX1

**QR | Skewer**

M10\*148.5mm(OLD:135mm)-Front

M10\*167mm(OLD: 150mm)-Front

M10\*190mm(OLD:170mm)-Rear

M10\*210mm(OLD:190mm)-Rear

**QR | Skewer : For Sram(w/o. Nut)**

12M\*167B(OLD:135mm)-Front

12M\*202B(OLD:170mm)-Rear

12M\*209B(OLD:177mm)-Rear

12M\*220B(OLD:190mm)-Rear

12M\*229B(OLD:197mm)-Rear

**SIZE | Skewer : For Shimano(W/Nut)**

12M\*165B(OLD:135mm)-Front

12M\*200B(OLD:170mm)-Rear

12M\*207B(OLD:177mm)-Rear

12M\*220B(OLD:190mm)-Rear

12M\*227B(OLD:197mm)-Rear



# | TRACK HUBS |



**TKF10** 232g

Bearings :  $\odot$  2 (6000\*2)  
 Gauge : 14  
 Holes : 20 , 24 , 28 , 32 , 36  
 O.L.D : 100mm  
 Axle : M9 , 3/8\*\*140mm (solid axle)  
 P.C.D :  $\varnothing$ 61.4



**TKR10** 273g

Bearings :  $\odot$  2 (6000\*2)  
 Gauge : 14  
 Holes : 20 , 24 , 28 , 32 , 36  
 O.L.D : 120mm  
 Axle : M10 , 3/8\*\*165mm (solid axle)  
 P.C.D :  $\varnothing$ 61.4

## COG

## Lock Ring

Type A

Type B

Type C

Type D

Type E

Type Light



SPHC-PO

NO : B100701  
 16T / t = 3.0  
 56g

NO : B100703  
 17T / t = 2.8  
 60g

NO : B100705  
 18T / t = 2.8  
 70g

SPHC-PO

NO : B100704  
 17T / t = 2.2  
 56g

NO : B100706  
 18T / t = 2.2  
 65g

SUS304

NO : B100708  
 18T / t = 2.2  
 54g

SPCC-PO

22T / t = 2.3  
 86g

SPCC-PO

21T / t = 2.3  
 79g

SCM430

16T / t = 3.0  
 45g

SPCC-PO

T = 5.0  
 18.5g

## | TRIKE/RECUMBENT BIKE |



**DH12N** 210.5g

Bearings :  $\odot$  2 (6001\*2)  
 Gauge : 14  
 Holes : 20 , 24 , 28 , 32  
 ID : 12mm(6001\*2) , 12.7mm(R8\*2)  
 15mm(6902\*2) , M10(6000\*2)  
 Flange C-C : 34mm  
 P.C.D :  $\varnothing$ 57



**DH12M** 214g

Bearings :  $\odot$  2 (6001\*2)  
 Gauge : 14  
 Holes : 28 , 32 , 36  
 ID : 12mm  
 Flange C-C : 58.5mm  
 P.C.D :  $\varnothing$ 57

**Steintrikes Co.**  
**Viktor Horvatski and Robert Stein**  
 The narrow DH12N hub for trikes that it is designed by Steintrikes for "16-18-20" wheels.

**DH15M** 243.5g

Bearings :  $\odot$  2 (6902\*2)  
 Gauge : 14  
 Holes : 28 , 32 , 36  
 ID : 15mm  
 Flange C-C : 58.55mm  
 P.C.D :  $\varnothing$ 57



**DH20M** 246.5g

Bearings :  $\odot$  2 (6805\*1+6904\*1)  
 Gauge : 14  
 Holes : 28 , 32 , 36  
 ID : 20mm  
 P.C.D :  $\varnothing$ 57



- Axle For DH20M  
 Length : 160mm  
 Weight : 83.6g  
 With End Cap

## | WHEEL CHAIR HUBS |



**DH12.7N** 396g(QR) 360g(Nut)

Bearings :  $\odot$  2 (R8\*2)  
 Gauge : 14  
 Holes : 20 , 24 , 28 , 32  
 ID : 12mm(6001\*2)  
 12.7mm(R8\*2)  
 Flange C-C : 34  
 Axle : QR (185.3g) or Nut (133g) Type  
 P.C.D :  $\varnothing$ 57.5

**DH12.7 AXLE**

Weight : 185.3g  
 Length : 1/2"\*131mm  
 Material : Stainless



# | SKEWER |



SK-MD01 45.5g(F+R)

Titanium Axle Skewer

Axle Material : Titanium

Lever Material : A7075

Parts Material : A7075

Color : ■



SK-MD02 44.5g(F+R)

Titanium Axle Skewer

Axle Material : Titanium

Lever Material : A7075

Parts Material : A7075

Color : ■



SK-MS01 44g(F+R)

Titanium Axle Skewer

Axle Material : Titanium

Lever Material : A7075

Parts Material : A7075

Color : ■

# | SKEWER |



**SK-NO8** 110g(F+R)

Cr-Mo Axle Skewer

Axle Material : Cr-Mo

Parts Material : A6061

Color : ■



**SK-MF46** 125g(F+R)

Cr-Mo Axle Skewer

Axle Material : Cr-Mo

Parts Material : A6061

Color : ■

For MTB Axle 12mm

This Skewer used for MTB Rear Hubs when with Axle 12mm.



**SK-R12**

Skewer for Shimano

Weight : 88g

Skewer for SRAM

Weight : 80g

Color : ■

### A701F 195g

ROAD BIKE FRONT

Bearings :  (Loose Balls)



Gauge : 14

Holes : 28 , 32 , 36

O.L.D : 100mm

Axle : 3/8" - 45C

P.C.D : Ø35

Color :  

\*A701QR Axle : M9



### A703R 300g

ROAD BIKE REAR

Bearings :  (Loose Balls)



Gauge : 14

Holes : 28 , 32 , 36

O.L.D : 126mm , 130mm , 135mm

Axle : 3/8" - 45C

P.C.D : Ø45.5

Color :  

\*A703QR Axle : M10



### CL100R 421.5g

MTB REAR

Bearings :  (Loose Balls)



Gauge : 14

Holes : 28 , 32 , 36

O.L.D : 135mm

Axle : M10 , 3/8" - 45C

P.C.D : Ø45

Color :  

\*CL100QR Axle : M10



### CS300R 421g

MTB REAR

Bearings :  2 (6000\*1+6200\*1)



Gauge : 14

Holes : 28 , 32 , 36

O.L.D : 135mm

Axle : 3/8" - Cro-Moli

P.C.D : Ø45.5

Color :  



### A781F 164.5g

MTB FRONT

Bearings :  2(6000\*2)



Gauge : 14

Holes : 20 , 24 , 28 , 32 , 36

O.L.D : 100mm

Axle : 3/8" - Cro-Moli

P.C.D : Ø35.5



Color :  



| ENTRY |

**DS200F** 282.5g



**MTB FRONT**

Bearings :  2 (6200\*2)  
 Gauge : 14  
 Holes : 28 , 32 , 36  
 O.L.D : 100mm  
 Axle : M10 - Cro-Moli  
 P.C.D : Ø57  
 Color :  



**DS200R** 465g

**MTB REAR**

Bearings :  2 (6200\*1+6000\*1)  
 Gauge : 14  
 Holes : 28 , 32 , 36  
 O.L.D : 135mm  
 Axle : M10 - Cro-Moli  
 P.C.D : Ø57  
 Color :  



**DL200F** 282.5g





**MTB FRONT**

Bearings :  (Loose Balls)  
 Gauge : 14  
 Holes : 28 , 32 , 36  
 O.L.D : 100mm  
 Axle : M10 - 45C  
 P.C.D : Ø57  
 Color :   



**DL200R** 465g

**MTB REAR**

Bearings :  (Loose Balls)  
 Gauge : 14  
 Holes : 28 , 32 , 36  
 O.L.D : 135mm  
 Axle : M10 - 45C  
 P.C.D : Ø57  
 Casstte : Steel  
 Color :   



**DL802F** 293g

**MTB FRONT**

Bearings :  (Loose Balls)  
 Gauge : 14  
 Holes : 32 , 36 , 48  
 O.L.D : 100mm  
 Axle : M10 , 3/8" - 45C  
 P.C.D : Ø60  
 Color : 



**DL803R** 363g

**MTB REAR**

Bearings :  (Loose Balls)  
 Gauge : 14  
 Holes : 32 , 36 , 48  
 O.L.D : 135mm  
 Axle : M10 , 3/8" - 45C  
 P.C.D : Ø60  
 Color : 



### A771F 200g

MTB FRONT

Bearings :  (Loose Balls)



Gauge : 14

Holes : 28 , 32 , 36

O.L.D : 100mm

Axle : M9 , 3/8" - 45C

P.C.D : Ø35

Color :  

\*A771QR Axle : M9



### A773R 308.5g

MTB REAR

Bearings :  (Loose Balls)



Gauge : 14

Holes : 28 , 32 , 36

O.L.D : 126mm , 130mm , 135mm

Axle : M10 , 3/8" - 45C

P.C.D : Ø45.5

Color :  



### A802F 306.5g

MTB FRONT

Bearings :  (Loose Balls)

Gauge : 14

Holes : 32 , 36 , 48

O.L.D : 100mm

Axle : 3/8" - 45C

P.C.D : Ø60

Color : 



### A803R 330g

MTB REAR

Bearings :  (Loose Balls)

Gauge : 14

Holes : 32 , 36 , 48

O.L.D : 130mm , 135mm

Axle : 3/8" - 45C

P.C.D : Ø60

Color : 



### A702SQ 151g

FOLDING BIKE FRONT

Bearings :  2 (6000\*2)

Gauge : 14



Spoke Holes : 20 , 24 , 28 , 32

O.L.D : 76mm

Flange C-C : 46.5mm

Axle : M9\*84mm - Cro-Moli

P.C.D : Ø35

Color :  



### A702F 155g

FOLDING BIKE FRONT

Bearings :  (Loose Balls)

Gauge : 14



Holes : 24 , 28 , 32

O.L.D : 76mm

Flange C-C : 46.5mm

Axle : 3/8"x115mm - 45C

P.C.D : Ø35

Color :  



# | ENTRY |

## A802F 306.5g

**BMX FRONT**

Bearings :  (Loose Balls)

Gauge : 14

Holes : 32 , 36 , 48

O.L.D : 100mm

Axle : M10 , 3/8" - 45C

P.C.D : Ø60

Color : 



## A802R 330g

**BMX REAR**

Bearings :  (Loose Balls)

Gauge : 14

Holes : 32 , 36 , 48

O.L.D : 112mm , 114mm

Axle : M10 , 3/8" - 45C

P.C.D : Ø60

Color : 



## A771F 200g

**BMX FRONT**

Bearings :  (Loose Balls)



Gauge : 14

Holes : 28 , 32 , 36

O.L.D : 100mm

Axle : M9 , 3/8" - 45C

P.C.D : Ø35

Color :  

\*A771QR Axle : M9



## A772R 300g

**BMX REAR**

Bearings :  (Loose Balls)



Gauge : 14

Holes : 28 , 32 , 36

O.L.D : 112mm , 114mm

Axle : M10 , 3/8" - 45C

P.C.D : Ø45.5

Color :  

\*A772QR Axle : M9



## A783SB 227g

**BMX REAR**

Bearings :  2 (6000\*2)

Gauge : 12 , 14

Holes : 28 , 32 , 36H

O.L.D : 112mm , 114mm

Axle : M10 - Cro-Moli

P.C.D : Ø45.5

Color : 





BITEX INDUSTRIAL CO., LTD.

Tel	886 - 4 - 2568 - 1568 886 - 4 - 2568 - 1569
Fax	886 - 4 - 2566 - 5647
E-mail	bitex@bitwxhubs.com
Website	www.bitexhubs.com
Add	76 Teh Sheng Rd.Taya, Taichung, Taiwan Design&Printing by mollic.com

