

PXH Digital Controller

**Easy configuration with pre-installed
Application Templates**



- **High Speed control-50ms Input sampling**
- **High Accuracy-0.1%**
- **Extensive number of I/O points** (AI : 3 points, DI : 9 points, DO : 9 points, AO : 2 points)
- **Enhanced Math Functions**
- **RS-485 Modbus Communications and Transmitter Power Supply options available**

HIGH SPEED, HIGH ACCURACY

50ms sampling cycle and 0.1% accuracy offer precise control.



Easy-to-view 5 digit display

0.01°C can be indicated.

input Universal-input (max. 2 points)

Thermocouple, RTD, voltage or current input is switchable on the front panel keys.

input Digital-input (Max. 9 points)

Applicable to SV/PID set, AT Start/Stand-by, Remote/Auto/Manual switch, Alarm-latch clear, et. al.

input Auxiliary Analog input (1 point)

Applicable to flow compensation and remote SV setting.

Math functions

Flow compensation, High/Low selector control, ratio, calorie calculation, et. al.

PC loader interface and software through RS-232C Communication

The loader software enables easy parameter setup.

output Control-output (3 types)

Selectable as relay, SSR/SSC drive and current.

output Digital-output (Max. 9 points)

Various event data as alarm and timer output are available.

output Auxiliary Analog output (Max. 2 points)

Max. two points out of PV/SV/MV/DV are available as analog output.

Transmitter Power Supply (Option) 24V DC, 23mA max.

RS485 Modbus communication function (option)

PID Palette

Max. 7 combinations of SV, PID are available.

Quick PID

ensures precise control to prevent overshoot and improve response to disturbances.
Applicable to various process controls including flow control and pressure control.



User friendly, Easy-to-view

Status indicator

displays SV select No. (at operation) and parameter No. (at setting)

Bargraph indicator

displays MV (12 segments)

Waterproof construction

is equipped on front panel as standard. NEMA4x (IEC standard IP66 equivalent)



Mode indicator

displays status as stand-by, control mode, output, alarm, etc.

PV indicator

has 5 digit display. 0.01°C indication is possible.(Character height : 20mm)

SV/MV indicator

displays SV and MV. (Character height : 13mm)

User function keys

offer one touch operation for Remote/Auto switch, Stand-by, Alarm-latch clear, AT, etc. is definable by user.



Easy configuration with control application templates

Pre-installed programming templates allow easy configuration for various applications.

Just by selecting appropriate "Application Template", input/output setting and internal calculation blocks can be automatically configured.

- Template (Control Type)
- Position proportional control type
- Position feedback control type
- Dual control type (Heat/Cool)
- 2 position control type
- Cascade control type
- Ratio control type
- 2 inputs switching control type
- 2 inputs selection control type
- Feed forward control type
- Ex-MV balance bumpless switching type
- ⋮

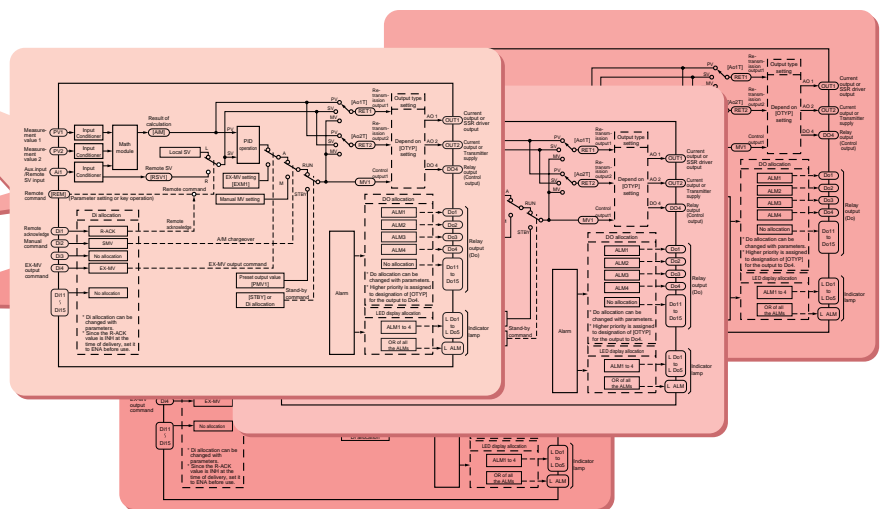

5 types of Basic "Application Templates" are pre-installed.

- PID
- PID + SV select
- PID + Mathematical Module
- PID + SV select + Mathematical Module
- PID + Input select + Mathematical Module

Additional templates will be available.

Cascade, Heat/Cool, Dual Loop, Totalization, Position feedback, Servo control
(Note : Under development)



Loader software enables easy parameter-settings

With standard loader software, Parameters can be easily uploaded/downloaded. PID tuning status can be easily viewed on PC.



Connection from standard loader port or from optional RS-485 communication.

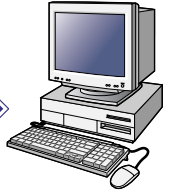

Menu

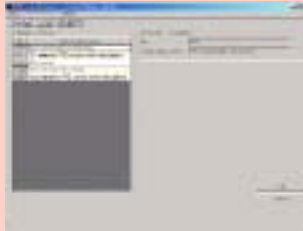

Template selection

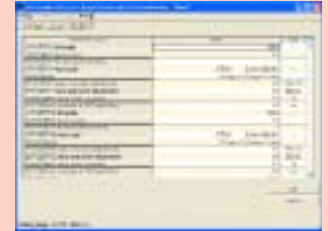

Parameter settings/changes



Preview for Parameter print

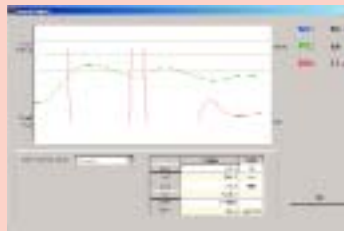

PID tuning status

Small instrumentation system is easily configurable

RS-485 (MODBUS) communication allows for connecting up to 31 units using any general-purpose SCADA software.



Max. 31 units can be connected by RS-485 (Modbus)

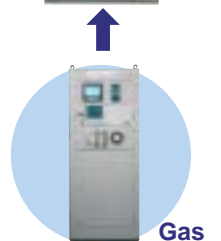
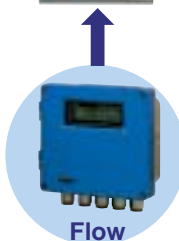
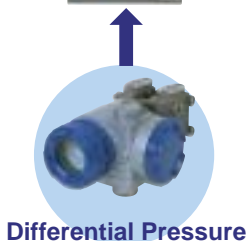
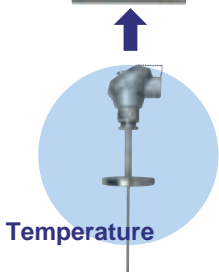

Other powerful features and functions

Mathematical Module (standard feature)

Useful for various applications involving process manipulation, input switching, etc. by the numeric operation between two or three inputs. User defined formulas can be applied to process and analog inputs.

(Data type : Engineering unit with floating decimal point)

Flow compensation, Average, High/Low selector, Input selector and etc.

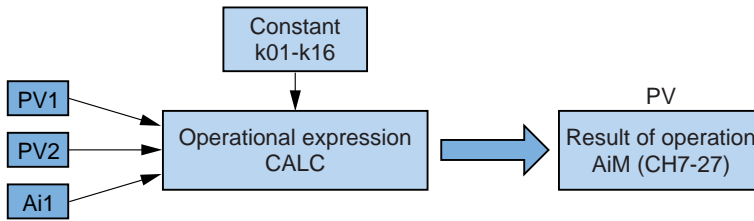

CALC set value	Name of operation	Math function
0	No operation	$AiM = PV1$
1	Expression 1 (Flow rate compensation calculation)	$AiM = k01 \times \sqrt[**1]{PV1} \times \sqrt[**2]{\frac{Ai1+k02}{k03} \times \frac{k04}{PV2+k05}}$ PV1 : Flow rate (Differential pressure), PV2 : Temperature, Ai1 : Pressure
2	Expression 2 (Flow rate compensation calculation)	$AiM = k01 \times PV1 \times \sqrt[**1]{\frac{Ai1+k02}{k03} \times \frac{k04}{PV2+k05}}$ PV1 : Flow rate (Differential pressure), PV2 : Temperature, Ai1 : Pressure
3	Expression 3 (Flow rate compensation calculation)	$AiM = k01 \times PV1 \times \frac{Ai1+k02}{k03} \times \frac{k04}{PV2+k05}$ PV1 : Flow rate (Differential pressure), PV2 : Temperature, Ai1 : Pressure
4	Expression 4	$AiM = \frac{(k01 \times (k02 \times PV1 + k03 \times PV2 + k04 \times Ai1) + k05)}{(k06 \times (k07 \times PV1 + k08 \times PV2 + k09 \times Ai1) + k10)}$
5	Expression 5	$AiM = \frac{(k01 \times ((k02 \times PV1 + k03) \times (k04 \times PV2 + k05) \times (k06 \times Ai1 + k07)) + k08)}{(k09 \times ((k10 \times PV1 + k11) \times (k12 \times PV2 + k13) \times (k14 \times Ai1 + k15)) + k16)}$
6	Expression 6	$AiM = k01 \times PV1 \times (k02 \times PV2 + k03 \times Ai1) + k04 \times Ai1 + k05$
7	H selector, 2 points	$AiM = \text{Max}(PV1, PV2)$ Use either PV1 or PV2 input, whichever is larger, as PV.
8	L selector, 2 points	$AiM = \text{Min}(PV1, PV2)$ Use either PV1 or PV2 input, whichever is smaller, as PV.
9	H selector, 3 points	$AiM = \text{Max}(PV1, PV2, Ai1)$ Use one out of PV1, PV2, or Ai1 input, whichever is largest, as PV.
10	L selector, 3 points	$AiM = \text{Min}(PV1, PV2, Ai1)$ Use one out of PV1, PV2, or Ai1 input, whichever is smallest, as PV.
11	Input switching, 2 points	$AiM = PV1$ when $PV1 \leq k01$, $PV2$ when $PV1 > k01$

*1 Square root extraction cut point can be set at k06.

*2 Square root extraction cut point can be set at k07.

Specifications

General	Size and Mass	96(W)×96(H)×81.5(L)mm, 500g	Output	Control output	One point to be selected from the followings 1. Relay contact output Contact structure : 1c (SPDT) contact (DO4 is used) Contact rating : AC220V/DC30V, 3A (Resistive load) AC220V/DC30V, 1A (Inductive load)
	Power supply	AC100 (-15%) - 240V (+10%), 50/60Hz			
	Power consumption	15VA or less (for AC100V) 20VA or less (for AC220V)			
	External terminals	Screw terminal (M3)			
Input	Measuring value input	Sampling cycle : 50ms Input type : Thermocouple, resistance bulb, DC Voltage/Current		Analog re-transmission output	Current output (DC4-20mA) Output type : PV, SV, MV, DV
	Auxiliary analog input (option)	Sampling cycle : 100ms Input type DC Voltage (DC1-5V, 0-5V, 0-10V)			
	Digital input	Number of input : 4 or 9 points Specification : Contact or transistor input Contact rating : DC12V, ca.2mA per point			
Function	Control method	2-degree-of-freedom PID control with Auto tuning		Digital output	Number of output : 2, 4, or 9 points Contact structure : 1c (SPDT) contact (DO4) 1a (SPST) contact (other than DO4) Contact rating : AC220V/DC30V, 1A (Resistive load)
	Controller type selection	with application templates			
	Control mode	Auto/Manual Auto/Manual/Remote			
	Alarm output	Max. 9 points as digital output			
	Memory back-up	by nonvolatile memory			
Indication	Accuracy	±0.1%±1digit of full scale		Transmitter power supply	DC24V (DC17-30V) Max. current 23mA
	PV indicator	LED 7 segments 5 digits (red color), character height: 20mm			
	SV indicator	LED 7 segments 5 digits (orange color), character height: 13mm			
	Status indicator	LED 7 segments 2 digits (orange color), character height: 12mm			
	Bargraph	LED 12 segments (orange color)			
	Mode indicator	Stand-by, Control mode, output, alarm			
			RS232C communication	Protocol	Modbus-RTU
				Speed	9600bps, 19200bps, 38400bps
			RS485 communication	Protocol	Modbus-RTU
				Speed	9600bps, 19200bps, 38400bps
			(Option)		
			Applied standards		UL, CE Mark

Ordering code

Digit	Description	PXH	4	5	6	7	8	9	10	11	12	13
4	<Size> 96x96mm	9	9	A			1		V			0
5	<Control loop function> 1 loop, PID controller			A								
6	<PV input> Universal input, 1 point Universal input, 2 points				1 2							
7	<Auxiliary input> None DC voltage					0 1						
8	<Version>						1					
9	<Output 1> Current Current Current SSR/SSC drive SSR/SSC drive	<Output 2> None Current Transmitter power supply None Current						1 2 5 A B				
10	<Power supply> 100 to 240 V AC 50/60Hz								V			
11	<Communication interface> None RS-485 (Modbus)									0 R		
12	<Digital input> 4 points (DI1 to 4) 4 points (DI1 to 4) 9 points (DI1 to 4, 11 to 15)	<Digital output> including control output relay output 2 points (DO3, 4) 4 points (DO1 to 4) 9 points (DO1 to 4, 11 to 15)									0 A B	

Note 1) The 6th digit "2" is not available with 12th digit "B".

2) DO4 is used for Relay contact as control output.

External dimensions (Unit : mm)

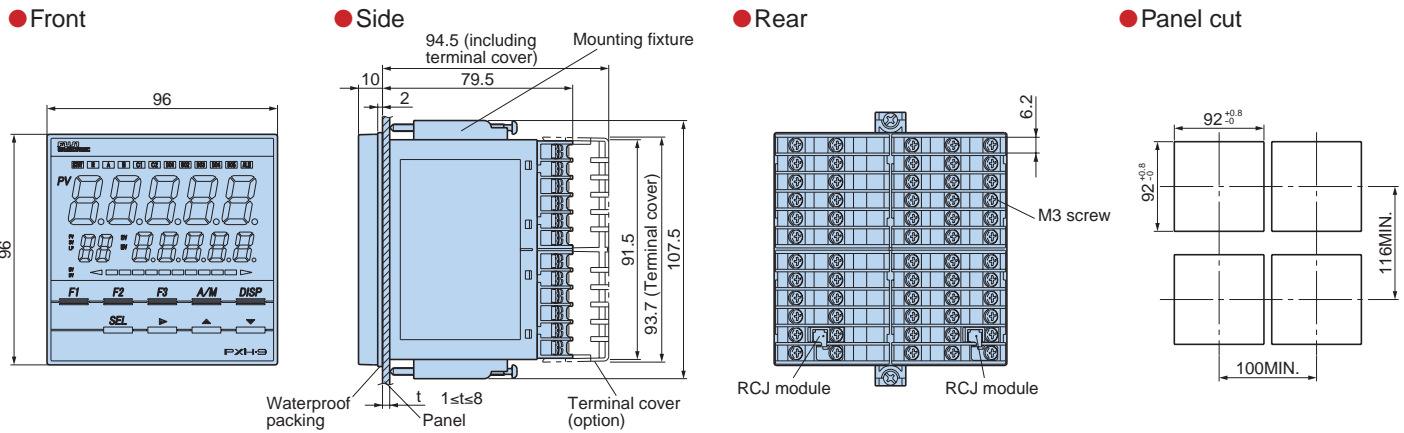

Scope of supply

Controller PXH, mounting fixture, waterproof packing for front face, engineering unit sheet, instruction manual, CD-ROM (includes PC loader, communication-manual, inst. manual, user-manual) and termination resistor in case communication interface is ordered.

⚠ Precautions for use

To ensure temperature process safety in case of PXH's failure, fit a separate over-temperature protection unit to isolate the heating circuit. Uncontrollability due to such failure may cause major accident.

Fuji Electric Systems Co., Ltd.

Head office
6-17, Sanbancho, Chiyoda-ku, Tokyo, 102-0075, Japan
<http://www.fesys.co.jp/eng>

Fuji Electric Instruments Co., Ltd.

Sales Div.
International Sales Dept.
No.1, Fuji-machi, Hino-city, Tokyo, 191-8502 Japan
Phone : 81-42-585-6201,6202
Fax : 81-42-585-6187
<http://www.fic-net.co.jp/eng>