

Portable Ultrasonic Flowmeter  
**PORTAFLOW X**

Quick Reference

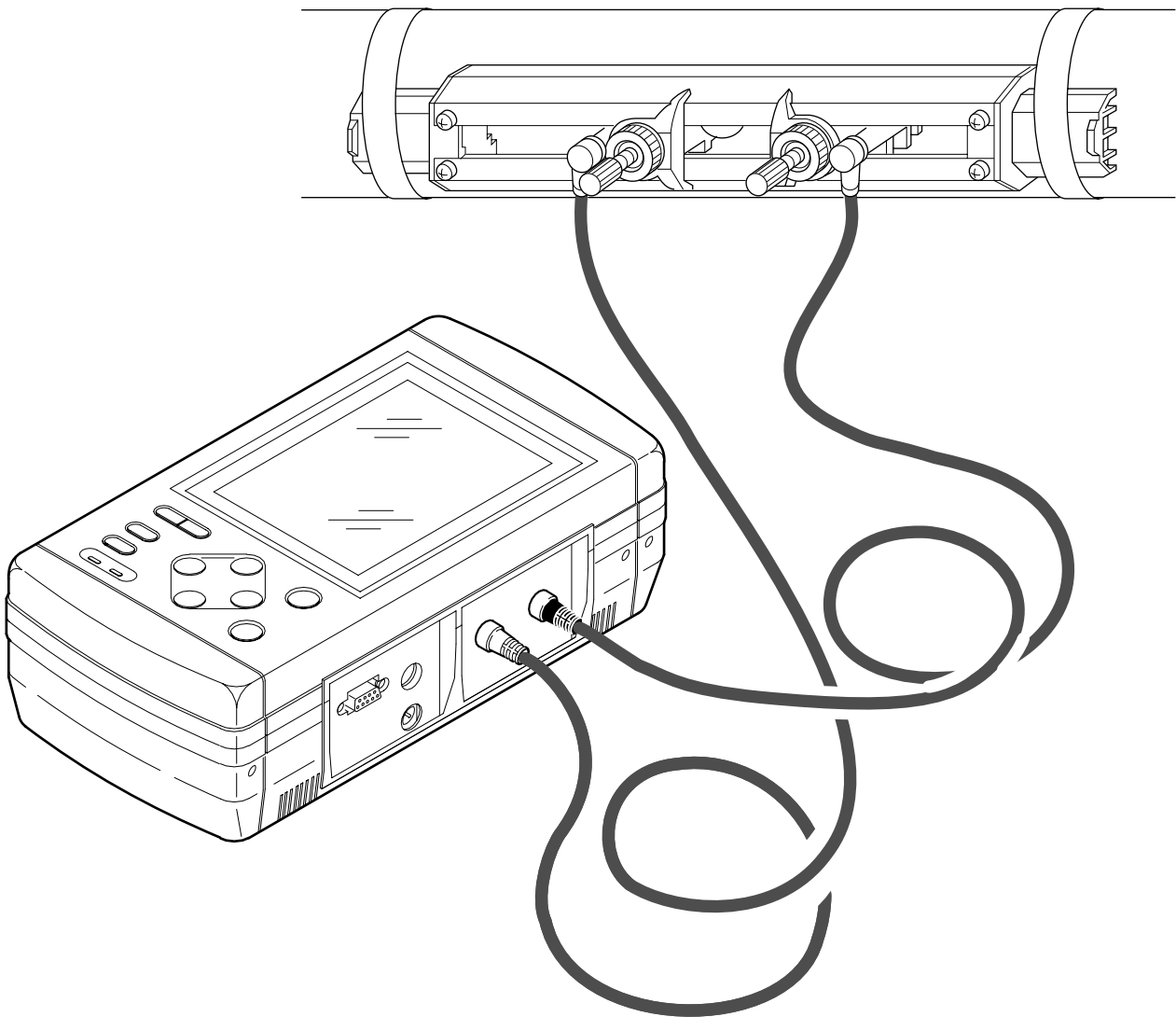



## CONTENTS

1.	STANDARD SELECTION OF DETECTOR .....	2
2.	CONDITIONS OF DETECTOR MOUNTING POSITIONS.....	3
3.	MEASURABLE FLUID .....	5
4.	PIPING CONDITIONS .....	6
5.	MOUNTING METHOD OF DETECTOR ON PIPING.....	7
6.	OPERATION .....	8
6.1	Power ON - How to Select the Language.....	11
6.2	Preparation Prior to Measurement (Zero Adjustment, etc.).....	12
6.3	Piping Specification Input Method through Determination of Size for Sensor Spacing .....	14
6.4	Error Status Display and Corrective Actions .....	16
6.5	Measurement of Fluid with Unknown Sonic Speed .....	18
7.	Q & A.....	20
7.1	How is piping setting made when piping specifications are unknown ? .....	20
7.2	What is the effect of coating outside the piping ? .....	20
7.3	What is the effect of scales in the piping ? .....	20
7.4	What is homogenous fluid through which ultrasonic waves are transmitted ? .....	20
7.5	Is it possible to measure the flow in piping that is not full ? .....	21
7.6	What happens when the liquid contains air bubbles ? .....	21
7.7	What about mounting the sensor on horizontal piping ? .....	22
7.8	What about mounting the sensor on vertical piping ? .....	22
7.9	When the length of straight piping is short and a pump, valve, orifice, etc. is present, what is required for measurement ? .....	22
7.10	How far can the sensor extension cord be extended ? .....	22
7.11	What is the approximate accuracy of measurement ? .....	23
7.12	What about error factors ? .....	23
7.13	What about comparison with other flowmeters ? .....	25
7.14	What is the difference between a Doppler type flowmeter and PORTAFLOW X ? .....	26
7.15	Life span of LCD .....	26
8.	DATA.....	27
(1)	Sonic Speed of Solid (at 25°C) .....	27
(2)	Sonic Speed of Water .....	27
(3)	Sonic Speed of Fluid .....	28

*Note) This manual provides information about the converter type 2.*

# 1. STANDARD SELECTION OF DETECTOR

## (1) Selection from 5 types according to applications

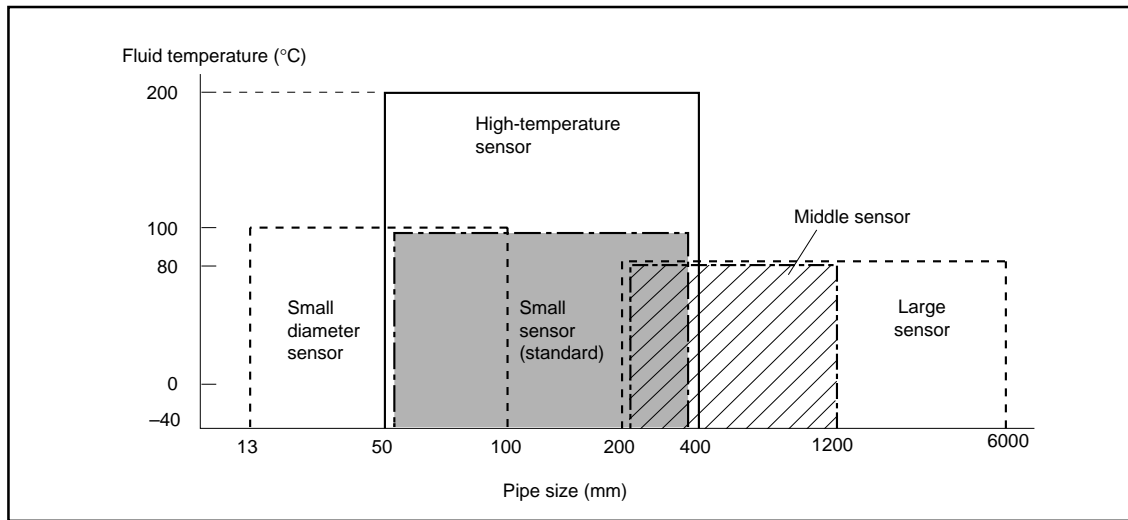

Detector	Type	Inside diameter (mm)	Temperature range (°C)
Small diameter sensor	FLD22	13 to 100	-40 to 100
Small sensor (standard)	FLD12	50 to 400	-40 to 100
Middle sensor	FLD41	200 to 1200	-40 to 80
Large sensor	FLD51	200 to 6000	-40 to 80
High-temperature sensor	FLD32	50 to 400	-40 to 200

## (2) Shape of each sensor

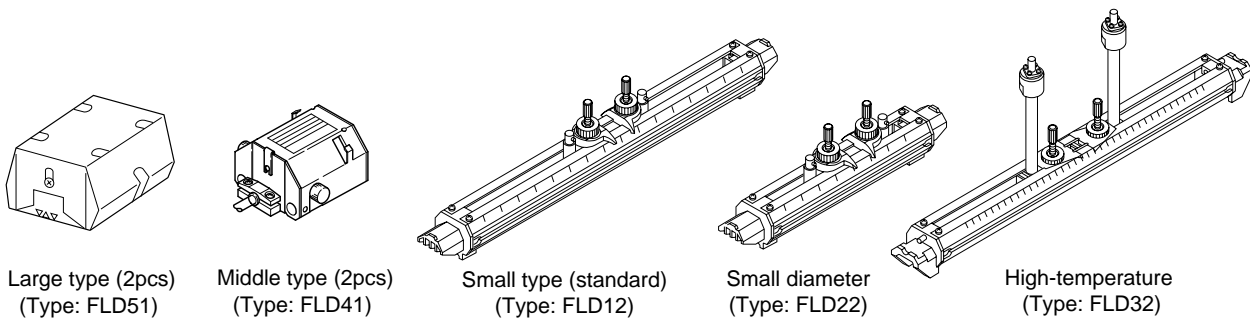

## (3) Example of sensors mounted on pipe

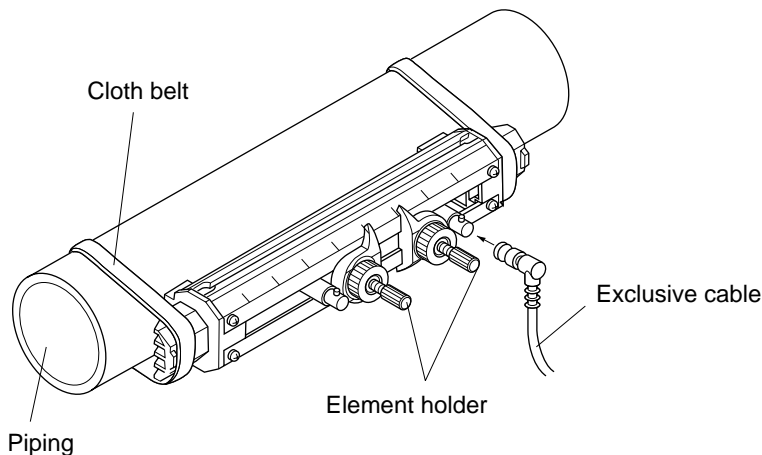

## 2. CONDITIONS OF DETECTOR MOUNTING POSITIONS

- The piping must be filled with fluid which is free from air bubbles and foreign objects.
- Straight piping greater than  $10D$  must exist on the upstream side and greater than  $5D$  on the downstream side.
- Elements (pump, valve, etc) on the upstream side must be greater than  $30D$  away to prevent disturbances.

### (1) Necessary straight pipe length

Classification	For upstream side	For downstream side
90° bend	<p>More than <math>10D</math></p> <p><math>L \geq 10D</math></p> <p>Detector</p>	<p><math>L \geq 5D</math></p>
Tee	<p>More than <math>10D</math></p> <p><math>L \geq 50D</math></p> <p>More than <math>10D</math></p>	<p><math>L \geq 10D</math></p>
Diffuser	<p>More than <math>0.5D</math></p> <p><math>L \geq 30D</math></p> <p><math>D</math></p> <p><math>\geq 1.5D</math></p>	<p><math>L \geq 5D</math></p>
Reducer	<p><math>L \geq 10D</math></p>	<p><math>L \geq 5D</math></p>
Valves	<p><math>L \geq 30D</math></p> <p>Flow control valve exists on upstream side.</p>	<p><math>L \geq 10D</math></p> <p>Flow control valve exists on downstream side.</p>
Pump	<p>Stop valve</p> <p>Check valve</p> <p><math>L \geq 50D</math></p>	

## (2) Detector mounting considerations

- 1) For horizontal piping, the detector should be mounted within  $\pm 45^\circ$  from the water level.  
For vertical piping, the detector can be mounted in any external position.

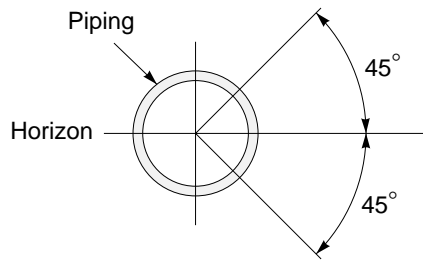

- 2) Avoid mounting the detector at positions with piping distortion, flange or welds.

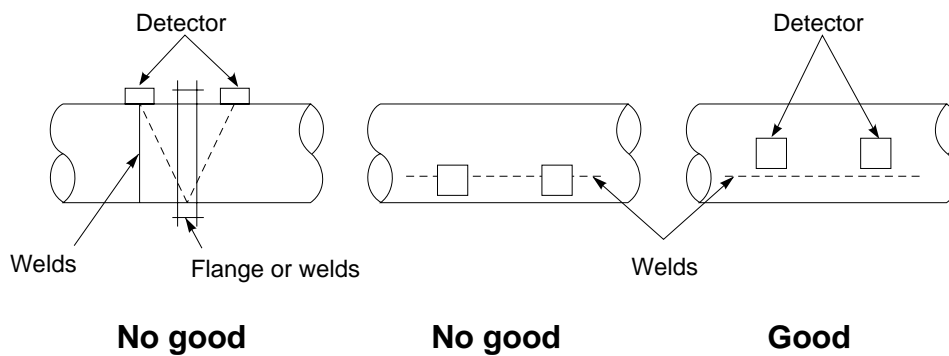

### 3. MEASURABLE FLUID

Item	Specifications																								
Measurable fluid	Ultrasonic propagative homogeneous fluids (water, seawater, oil or fluid even with unknown sonic speed), including the following liquids. <table border="1" data-bbox="668 441 1240 806" style="margin-left: auto; margin-right: auto;"> <tbody> <tr> <td>Acetone</td> <td>Heavy water</td> </tr> <tr> <td>Aniline</td> <td>Carbon tetrachloride</td> </tr> <tr> <td>Ether</td> <td>Mercury</td> </tr> <tr> <td>Ethylene glycol</td> <td>Nitrobenzene</td> </tr> <tr> <td>Chloroform</td> <td>Carbon bisulfide</td> </tr> <tr> <td>Glycerin</td> <td>n. pentane</td> </tr> <tr> <td>Acetic acid</td> <td>n. hexane</td> </tr> <tr> <td>Methyl acetate</td> <td>Spindle oil</td> </tr> <tr> <td>Ethyl acetate</td> <td>Gasoline</td> </tr> </tbody> </table>	Acetone	Heavy water	Aniline	Carbon tetrachloride	Ether	Mercury	Ethylene glycol	Nitrobenzene	Chloroform	Carbon bisulfide	Glycerin	n. pentane	Acetic acid	n. hexane	Methyl acetate	Spindle oil	Ethyl acetate	Gasoline						
Acetone	Heavy water																								
Aniline	Carbon tetrachloride																								
Ether	Mercury																								
Ethylene glycol	Nitrobenzene																								
Chloroform	Carbon bisulfide																								
Glycerin	n. pentane																								
Acetic acid	n. hexane																								
Methyl acetate	Spindle oil																								
Ethyl acetate	Gasoline																								
Fluid turbidity	10000 (mg/L) or less																								
Flow condition	Full-filled,axisymmetric and well developed flow																								
Fluid temperature per detector	<table border="1" data-bbox="464 1043 1474 1288"> <thead> <tr> <th>Detector</th> <th>Type</th> <th>Inside diameter (mm)</th> <th>Temperature range (°C)</th> </tr> </thead> <tbody> <tr> <td>Small diameter sensor</td> <td>FLD22</td> <td>13 to 100</td> <td>-40 to 100</td> </tr> <tr> <td>Small sensor (standard)</td> <td>FLD12</td> <td>50 to 400</td> <td>-40 to 100</td> </tr> <tr> <td>Middle sensor</td> <td>FLD41</td> <td>200 to 1200</td> <td>-40 to 80</td> </tr> <tr> <td>Large sensor</td> <td>FLD51</td> <td>200 to 6000</td> <td>-40 to 80</td> </tr> <tr> <td>High-temperature sensor</td> <td>FLD32</td> <td>50 to 400</td> <td>-40 to 200</td> </tr> </tbody> </table>	Detector	Type	Inside diameter (mm)	Temperature range (°C)	Small diameter sensor	FLD22	13 to 100	-40 to 100	Small sensor (standard)	FLD12	50 to 400	-40 to 100	Middle sensor	FLD41	200 to 1200	-40 to 80	Large sensor	FLD51	200 to 6000	-40 to 80	High-temperature sensor	FLD32	50 to 400	-40 to 200
Detector	Type	Inside diameter (mm)	Temperature range (°C)																						
Small diameter sensor	FLD22	13 to 100	-40 to 100																						
Small sensor (standard)	FLD12	50 to 400	-40 to 100																						
Middle sensor	FLD41	200 to 1200	-40 to 80																						
Large sensor	FLD51	200 to 6000	-40 to 80																						
High-temperature sensor	FLD32	50 to 400	-40 to 200																						
Velocity range	- 32 to 0 to +32m/s																								

## 4. PIPING CONDITIONS

---

Item	Specifications																
Piping diameter	Small diameter sensor : $\phi 13$ to $\phi 100\text{mm}$ Small sensor (standard) : $\phi 50$ to $\phi 400\text{mm}$ Middle sensor : $\phi 200$ to $\phi 1200\text{mm}$ Large sensor : $\phi 200$ to $\phi 6000\text{mm}$ High-temperature sensor : $\phi 50$ to $\phi 400\text{mm}$																
Piping materials	<table border="0"> <tr> <td>Iron</td> <td>Brass</td> </tr> <tr> <td>Copper</td> <td>Polyvinyl chloride</td> </tr> <tr> <td>Ductile cast iron</td> <td>Acrylic resin</td> </tr> <tr> <td>Cast iron</td> <td>Mortar</td> </tr> <tr> <td>Stainless steel</td> <td>Tar epoxide</td> </tr> <tr> <td>Steel</td> <td>Polyethylene</td> </tr> <tr> <td>Lead</td> <td>Teflon</td> </tr> <tr> <td>Aluminum</td> <td>FRP</td> </tr> </table>	Iron	Brass	Copper	Polyvinyl chloride	Ductile cast iron	Acrylic resin	Cast iron	Mortar	Stainless steel	Tar epoxide	Steel	Polyethylene	Lead	Teflon	Aluminum	FRP
Iron	Brass																
Copper	Polyvinyl chloride																
Ductile cast iron	Acrylic resin																
Cast iron	Mortar																
Stainless steel	Tar epoxide																
Steel	Polyethylene																
Lead	Teflon																
Aluminum	FRP																
Lining materials (coating materials for piping interior)	None Tar epoxide Mortar Rubber Teflon Pilex glass or materials with known sonic speed																



## 5. MOUNTING METHOD OF DETECTOR ON PIPING

Enter the piping specifications in the parameter of the converter to determine the sensor mounting dimension and then mount the sensor on the piping.

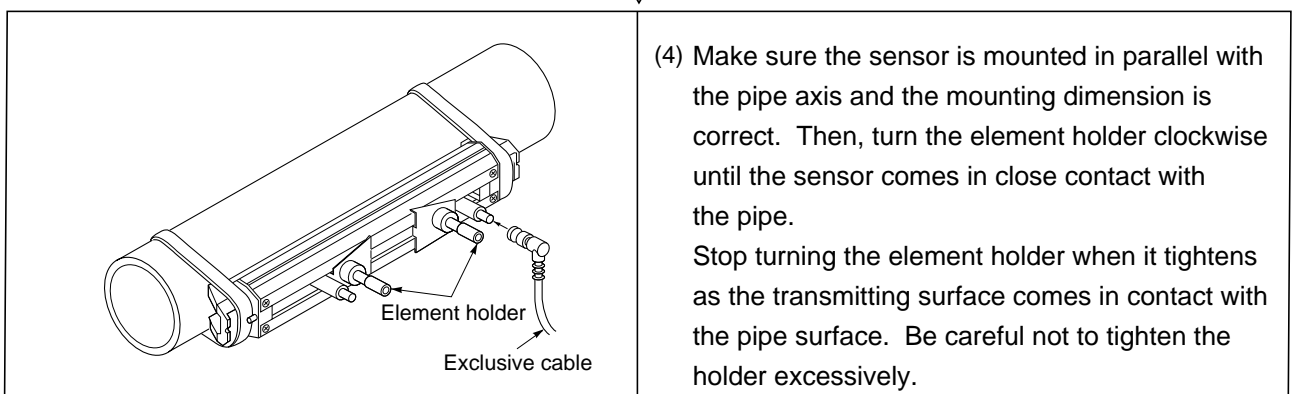
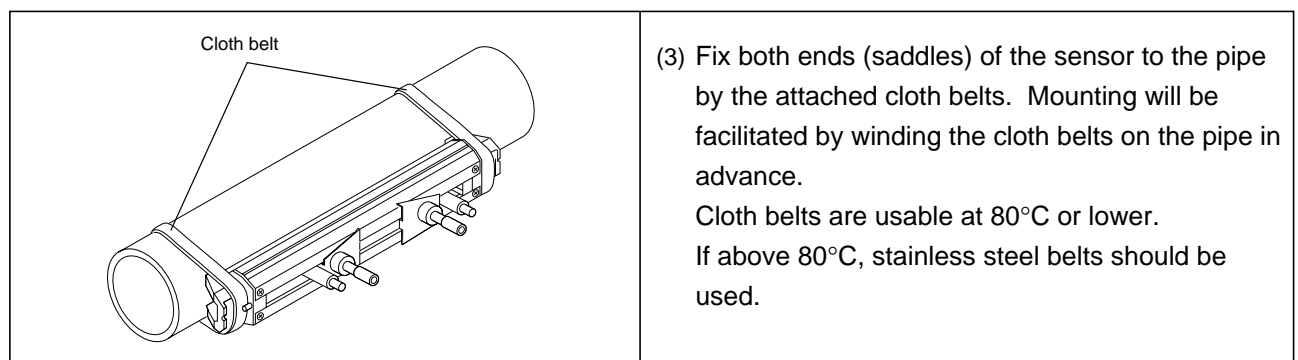
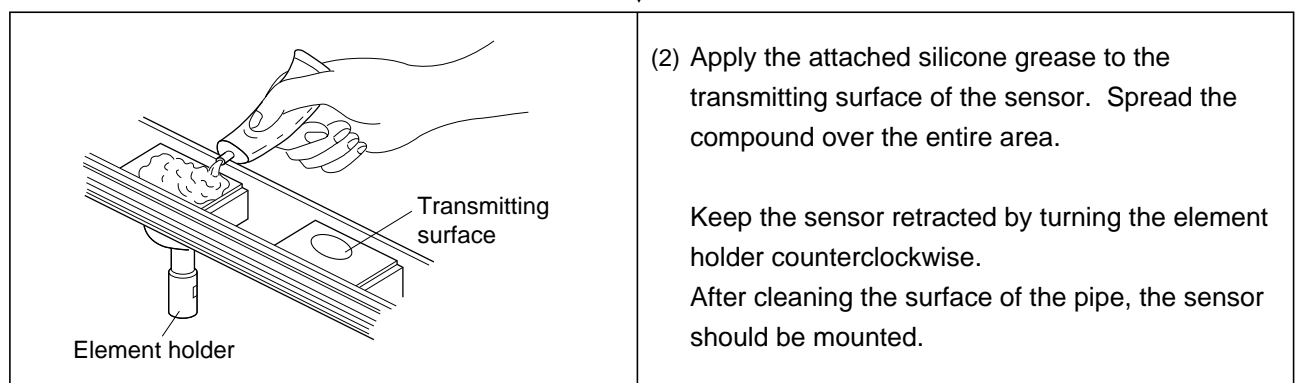
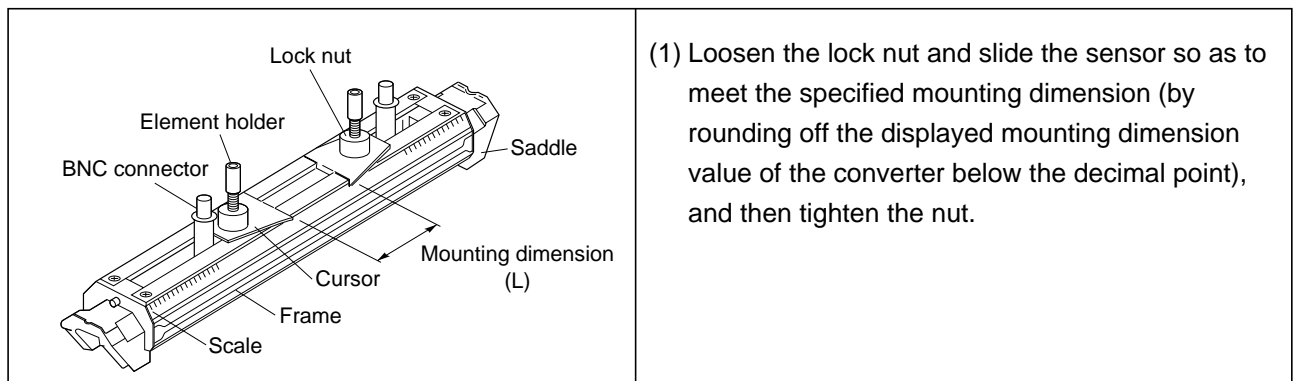

## 6. OPERATION



Be sure to read the following items and record (check) the next page before using the flowmeter. Read these data together with the instruction manual.

- (1) Make sure that the inside diameter of the piping being measured conforms to the sensor type.

Detector	Type	Inside diameter (mm)	Temperature range (°C)
Small diameter sensor	FLD22	13 to 100	-40 to 100
Small sensor (standard)	FLD12	50 to 400	-40 to 100
Middle sensor	FLD41	200 to 1200	-40 to 80
Large sensor	FLD51	200 to 6000	-40 to 80
High-temperature sensor	FLD32	50 to 400	-40 to 200

- (2) Check the lengths of the straight pipe upstream and downstream of the sensor mounting position.

- Straight piping greater than 10D must exist on the upstream side and greater than 5D on the downstream side.
- Elements (pump, valve, etc) on the upstream side must be greater than 30D away to prevent disturbances.

- (3) Check if the piping setting (outside diameter, material, thickness, etc.) is correct.

- If the sensor mounting size is not calculated correctly, errors will occur such as window scan (reception range-over) or no received signal.

- (4) Check if the sensor is mounted correctly.

- If the transmission side of the sensor is not coated sufficiently with silicone grease, receiving signals will become unstable or errors will occur such as window scans (receiving range-over), no received signals, etc.
- If the upstream and downstream side connectors are reversed, a negative flow rate will be indicated.

- (5) Make sure that the zero point adjustment is completed.

- Fill the piping with measuring fluid, then stop the flow of the fluid to perform a manual zero adjustment.

- (6) Check to see if more than 2 indicators on the upper right of the measurement screen are working to indicate wave reception.

- If no indicator is displayed, or if only one is displayed, increase the level of the transmission voltage.

- (7) Check if the analog output range is set correctly.

- Even when the analog output is not used, an error of analog scale-over will occur unless the analog output range has been set properly.

**\* Preparations for measurement have been completed.**



Set the integrator, logger, printer, etc., as necessary. Check whether the flow rate is indicated correctly. If an error message is indicated, display the system check screen and press the ENT key while setting the cursor on the error checker.

At this time, the error data, the cause of the error and procedures to correct the error are indicated. Operate the flowmeter according to the instructions.



Be sure to record (check) the following items before using the flowmeter.

Date of recording [      day    month      year]    Place of measurement \_\_\_\_\_

Recorded by \_\_\_\_\_

(1) Check the inside diameter of the piping to insure it conforms to the sensor type.

Detector	Type	(Mark ○ on sensor in use)	Piping inside diameter
Small diameter sensor	FLD22		mm
Small sensor (standard)	FLD12		mm
Middle sensor	FLD41		mm
Large sensor	FLD51		mm
High-temperature sensor	FLD32		mm

(2) Check for sufficient lengths of straight pipe upstream and downstream of the sensor mounting position.

	Straight piping	Pump, valve, etc.
Upstream side	D	With / Without
Downstream side	D	With / Without

(3) Check for correct piping settings (outer diameter size, material, thickness, etc.).

1. Site name		7. Kind of fluid	Water / Sea-water / (    )
2. Piping outer diameter size	mm	* Sea-water/Coefficient of kinematic viscosity	m <sup>2</sup> /s
3. Piping material		* Other/Fluid sound speed	m/s
* Other (sonic speed setting)	m/s	* Other/Coefficient of kinematic viscosity	m <sup>2</sup> /s
4. Piping thickness (mm)	mm	8. Sensor mounting method	V method / Z method
5. Lining material		9. Type of sensor	
* Other (sonic speed setting)	m/s	10. Transmission voltage	×1 / ×2 / ×4 / ×8
6. Lining thickness	mm	11. Mounting size	mm

(4) Check for correct sensor mounting.

Silicone grease coating	No / Yes
Connector connection check	No / Yes

(5) Check the zero point adjustment.

Zero point adjustment method: Manual zero clear (stop the flow of fluid for manual zero operation.)

## 6. OPERATION

---

(6) Check that more than 2 indicators on the upper right of the measurement screen are working to indicate received waves.

Number of working indicators: [ ] (If neither indicator or only one indicator is working, increase the transmission voltage.)

(7) Check if the analog output range is set properly.

Output range set value: □.□□□ε□

\* Recording (check) has been finished. Set the integrator, logger, printer, etc., as necessary.



Check if the flow rate is indicated correctly. If an error message is indicated, display the system check screen and press the ENT key while setting the cursor on the error check.

At this time, the error data, the cause of the error and corrective action are indicated. Follow the operating instructions displayed on the screen.

## 6.1 Power ON - How to Select the Language

At the time of purchase of the flowmeter, English is used as the display language. To change it into Japanese, German or French, use the following procedure.

Once a language is set, it is stored in memory and it is not necessary to reset every time the power OFF.

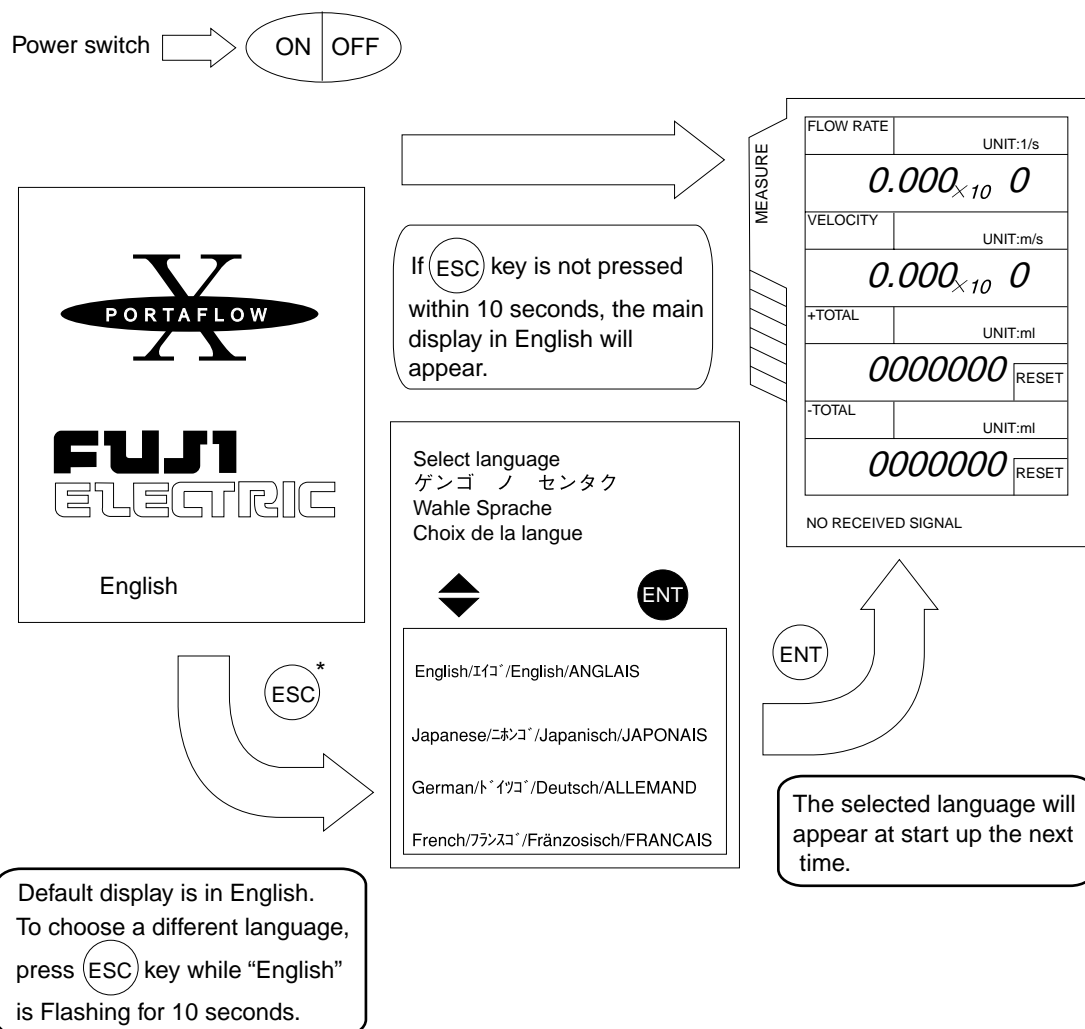

## 6.2 Preparation Prior to Measurement (Zero Adjustment, etc.)

Detector	Type	Inside diameter (mm)	Temperature range (°C)
Small diameter sensor	FLD22	13 to 100	-40 to 100
Small sensor (standard)	FLD12	50 to 400	-40 to 100
Middle sensor	FLD41	200 to 1200	-40 to 80
Large sensor	FLD51	200 to 6000	-40 to 80
High-temperature sensor	FLD32	50 to 400	-40 to 200

- \* Straight piping greater than 10D must exist on the upstream side and greater than 5D on the downstream side.
- \* Elements (pump, valve, etc) on the upstream side must be greater than 30D away to prevent disturbances.

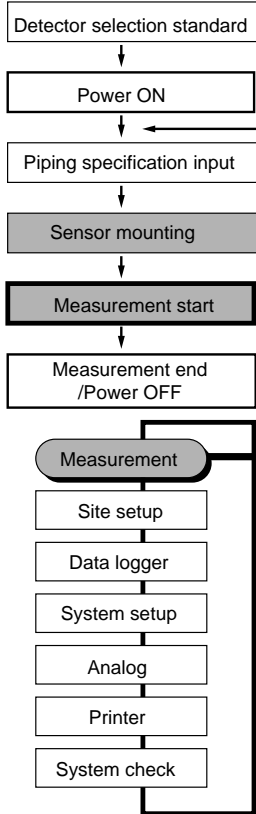

When the power is ON, the language select screen is displayed. Select the language to be used and then press the ENT key.

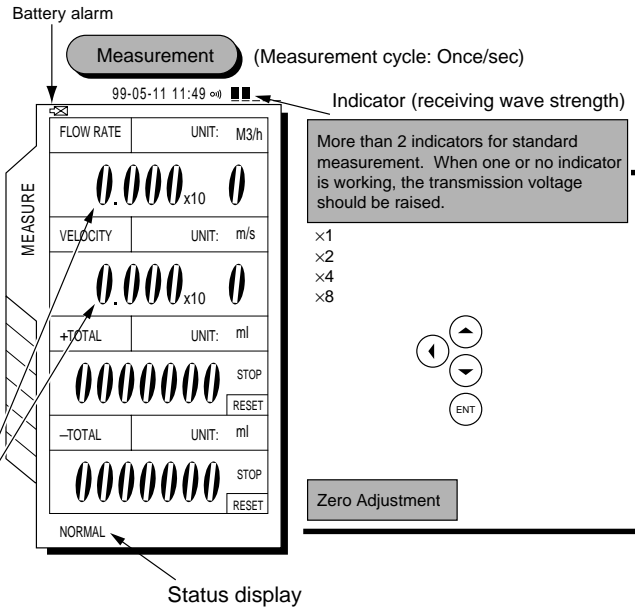

x10 0 = 0  
 x10 1 = 10  
 x10 2 = 100  
 Example) 1.200x10 2 corresponds to 1.2 x 100 = 120m<sup>3</sup> /h.

**Description of key symbols**

- ENT : ENTRY key (data registration)
- ESC : ESCAPE key (setting suspension)
- ↑ : Cursor up-shift (set value feed)
- ↓ : Cursor down-shift (set value return)
- ← : Cursor left-shift (scale change)
- : Cursor right-shift (scale change)
- PRINT : Display screen printout (hard copy)

**Important!**

- (1) Selection of detector mounting position**
  - Straight piping greater than 10D must exist on the upstream side and greater than 5D on the downstream side.
  - Elements (pump, valve, etc) on the upstream side must be greater than 30D away to prevent disturbances
  - The piping must be filled with fluid free from air bubbles and foreign objects.
- (2) Selection of mounting method**  
 Small diameter sensor and small type (standard) sensor should be mounted by the V method. In the following cases, the Z method should be used for mounting.
  - Insufficient mounting space (about 1/2 of the size of the V method)
  - Piping with mortar lining
  - Piping is old and presumed to have a deposit of a thick layer of scales inside the piping.
- (3) Treatment of detector mounting side**
  - Using thinner and sand-paper, remove the pitches, rust and uneven surface of the detector mounting piping over the entire mounting area of (L) + 200mm wide.
  - When the piping exterior is wrapped with jute, remove the jute and then perform the above treatment.
  - Horizontal piping should be mounted within ±45° from the horizon.
  - Vertical piping can be mounted at any external position.
- (4) Method of mounting for small sensor (standard) and small diameter sensors** (refer to Page 7 of this manual)
  - Loosen the lock nut. After setting to the mounting position, tighten the lock nut.
  - Coat the sensor transmission side with a sufficient amount of silicone grease.
  - Attach both ends (saddle) to the piping using a cloth belt.
  - Make sure that the sensor is mounted in parallel with the piping and that the mounting position is correct. Then, turn the element holder clockwise until the sensor is firmly fitted to the piping (clockwise; element moves down, anti-clockwise; element moves up).

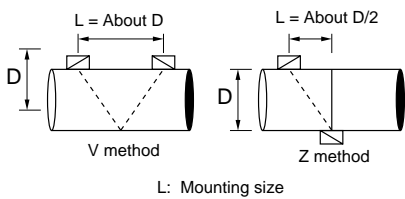

**Important !**

Adjustment with "Site setting/Transmission voltage"

- (1) Insufficient coating of grease on the sensor
- (2) Air stays in the piping.
- (3) When the inside of the piping is rusted or the lining material is peeled off, the number of indicators will not increase even if the transmission voltage is raised.
- (4) When transmission voltage is raised unnecessarily, the battery power will be consumed quickly during battery drive (no problems with measurement ).

**Site setup**

Stop the flow for zero adjustment

SITE SETUP	
SITE MEMORY	
PIPE PARAMETER	
ZERO ADJUST	MANUAL ZERO
RESPONSE SET	0 sec
CALIBRATION	
CUT OFF	0.000 m/s
TOTALIZE	
-- SENSOR SPACING --	
255.1mm	

**Important !**

Under the flow stop condition, set the cursor for manual zero adjustment and press the ENT key (compulsory zero adjustment).

ZERO ADJUST
MANUAL ZERO
CLEAR

This is used when the flow cannot be stopped. Since the exact zero adjustment cannot be obtained (output is within the range of allowable error), the manual zero adjustment should be performed after stopping the flow.

This is the result of automatic calculation. It can be changed by piping specification input.

**Site setup**

SITE SETUP	
SITE MEMORY	
PIPE PARAMETER	
ZERO ADJUST	MANUAL ZERO
RESPONSE SET	0 sec
CALIBRATION	
CUT OFF	0.000 m/s
TOTALIZE	
-- SENSOR SPACING --	
255.1mm	

**Important !**

CALIBRATION	
ZERO	0.000m/s
SPAN	100.0

In general, 0.000m/s is used for zero, and 100.00% is used for span.

Note that when this value changes, the output deviates by the amount of the change.  
Example) When the span is set to 0.0%, the instantaneous value 0.0 remains unchanged.





Table 1: Sonic speed of piping material

Material	Vm/s
Iron	3230
Copper	3206
Ductile cast iron	3000
Cast iron	2460
Stainless steel	3206
Steel	2260
Lead	2170
Aluminum	3080
Brass	2050
Polyvinyl chloride	2640
Acrylic resin	2644
FRP	2505
Mortar	2500
Tar epoxide	2505
Polyethylene	1900
Teflon	1240

V: Sonic speed

Table 2: Coefficient of kinematic viscosity of various fluids

Fluid name	T°C	pg/cm <sup>3</sup>	Vm/s	v (x10-6m <sup>2</sup> /s)
Acetone	20	0.7905	1190	0.407
Aniline	20	1.0216	1659	1.762
Ether	20	0.7135	1006	0.336
Ethylene glycol	20	1.1131	1666	21.112
Chloroform	20	1.4870	1001	0.383
Glycerin	20	1.2613	1923	1188.500
Acetic acid	20	1.0495	1159	1.162
Methyl acetate	20	0.9280	1181	0.411
Ethyl acetate	20	0.9000	1164	0.499
Heavy water	20	1.1053	1388	1.129
Carbon tetrachloride	20	1.5942	938	0.608
Mercury	20	13.5955	1451	0.114
Nitrobenzene	20	1.2070	1473	1.665
Carbon bisulfide	20	1.2634	1158	0.290
n. pentane	20	0.6260	1032	0.366
n. hexane	20	0.6540	1083	0.489
Spindle oil	32	0.9050	1324	15.700
Gasoline	34	0.8030	1250	0.4-0.5
Water	13.5	1.0000	1460	1.004 (20°C)

T: Temperature p: Density V: Sonic speed  
n: Coefficient of kinematic viscosity

Note) For other fluids, see "DATA" given in Chapter 8.

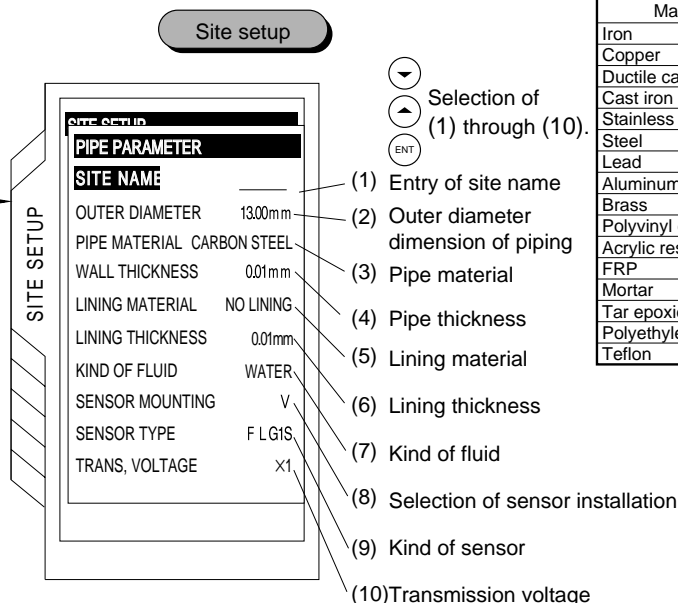

**(4) Piping thickness**  
(Unit: mm)

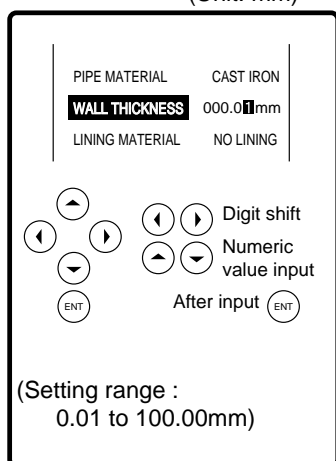

**(5) Lining material**

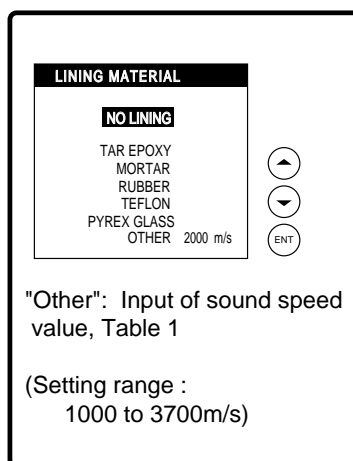

**(6) Lining thickness**  
(Unit: mm)

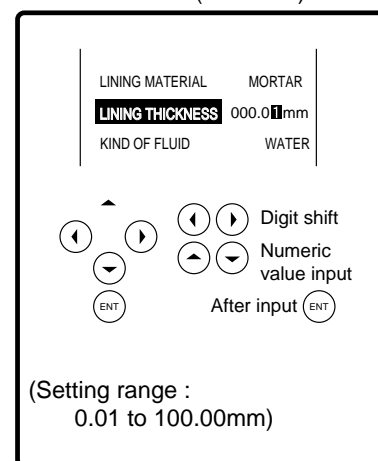

**(9) Kind of sensor**

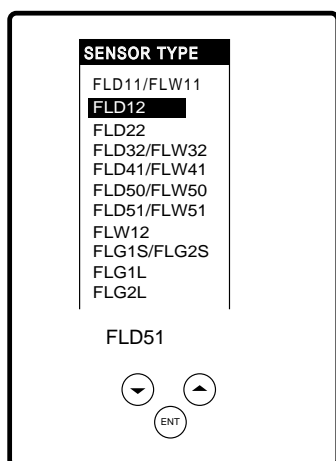

**(10) Transmission voltage**

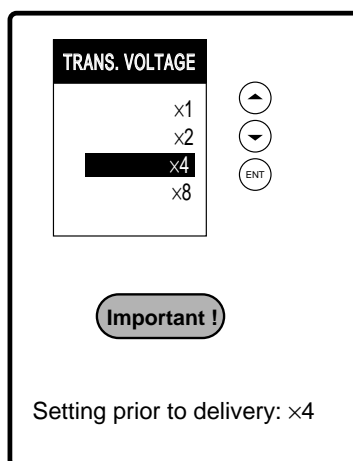

**(11) Determination of mounting size**

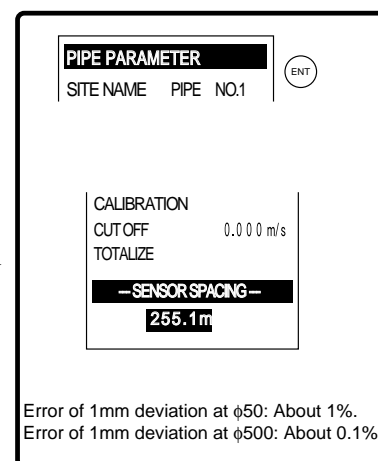

## 6.4 Error Status Display and Corrective Actions

Detector	Type	Inside diameter (mm)	Temperature range (°C)
Small diameter sensor	FLD22	13 to 100	-40 to 100
Small sensor (standard)	FLD12	50 to 400	-40 to 100
Middle sensor	FLD41	200 to 1200	-40 to 80
Large sensor	FLD51	200 to 6000	-40 to 80
High-temperature sensor	FLD32	50 to 400	-40 to 200

- \* Straight piping greater than 10D must exist on the upstream side and greater than 5D on the downstream side.
- \* Elements (pump, valve, etc) on the upstream side must be greater than 30D away to prevent disturbances.

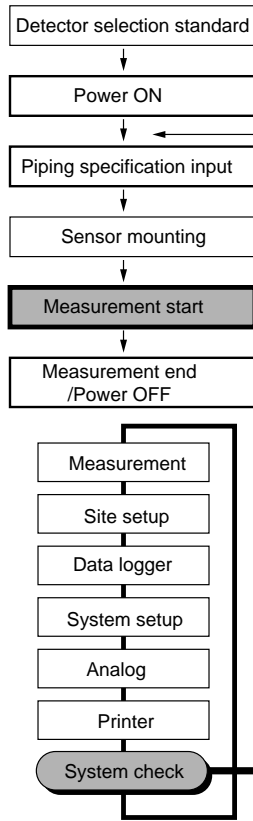

When the power is ON, the language select screen is displayed. Select the language to be used and then press the ENT key.

**Important !**  
The error check screen is used to display error status and the corrective actions, it is not used to display the state of occurrence of errors.  
(Do not misunderstand it for occurrence of too many errors.)

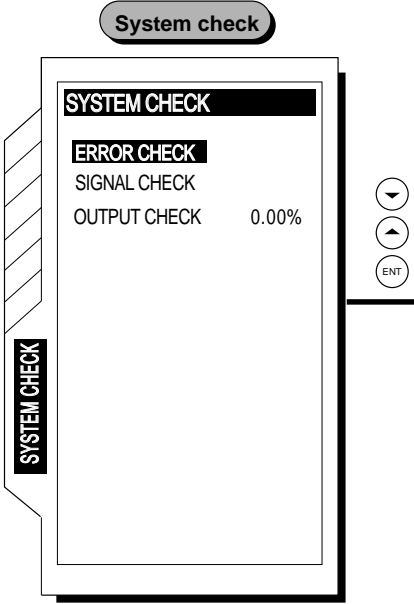

### (1) Module-to-module communication failure (major fault)

Internal data communication is abnormal.

- Reset the power source. (SW ON - OFF)
- If the instrument does not recover, it is an indication of malfunction. Contact your dealer for repair.

### (2) Measurement module failure

Measurement module is abnormal and cannot be used for measurement.

- Reset the power source. (SW ON - OFF)
- If the instrument does not recover, it is an indication of malfunction. Contact your dealer for repair.

### (3) Calculation failure

Measurement calculation is abnormal.

- Confirm the set data.
- Reset the power source. (SW ON - OFF)
- If the instrument does not recover, it is an indication of malfunction. Contact your dealer for repair.

### (4) Printer failure

The printer has a problem and cannot be used for printing.

- Is the printer power turned on?
- Check to see if paper is jammed. Also, make sure that the printer is connected correctly to the main unit.
- Reset the power source for the main unit and printer.

### (5) Receiving signal fluctuation

Measurement is impossible due to fluctuation of received ultrasonic waveform.

- Check to see if a large quantity of air bubbles or foreign objects have entered the piping.
- Change the sensor mounting position.
- Remove the cause of air bubbles or foreign objects.
- Check if the dedicated cable is improperly plugged in or disconnected.

#### Description of key symbols

- ENT : ENTRY key (data registration)
- ESC : ESCAPE key (setting suspension)
- ▲ : Cursor up-shift (set value feed)
- ▼ : Cursor down-shift (set value return)
- ◀ : Cursor left-shift (scale change)
- ▶ : Cursor right-shift (scale change)
- PRINT : Display screen printout (hard copy)

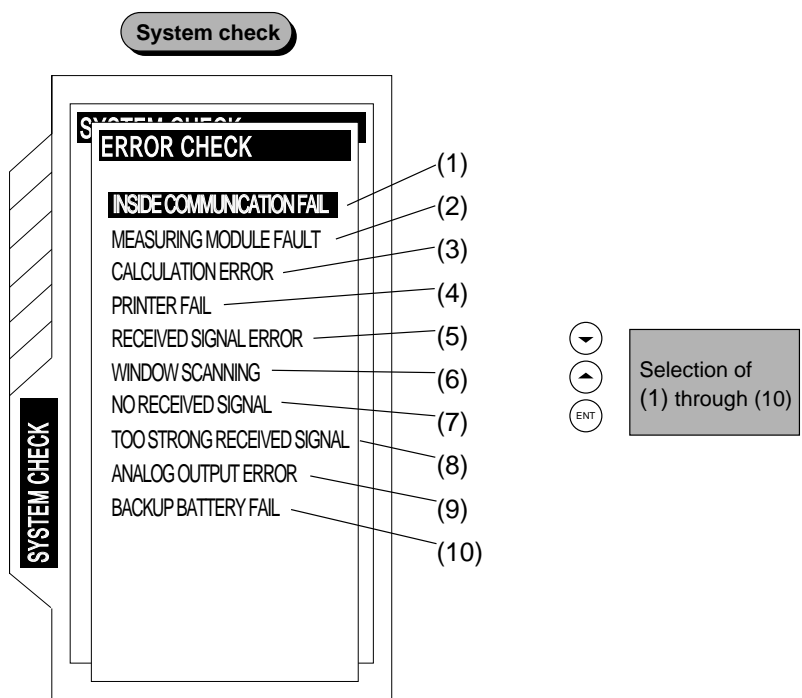

**(6) Window scan**

Received signal is lost in the measurement window. It is being searched.

- Check the setting of piping data.
- Open the PIPE PARAMETER screen. Measurement operation is reset and window scanning will start (It is not an error).

**(7) No received signal**

Ultrasonic waveform is lost.

- Check the setting of piping data.
- Check the sensor mounting size.
- Check the connection of the cable.
- Raise the transmission voltage.

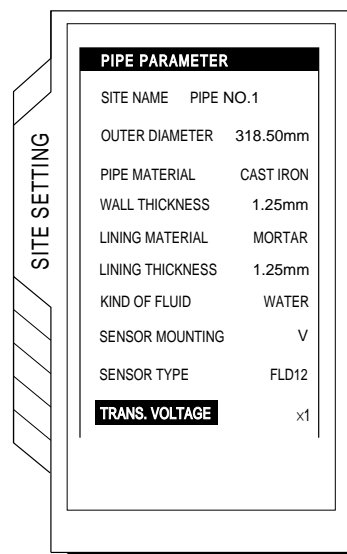

**(8) Receiving signal overflow**

Overflow of the strength of ultrasonic received signal

- Change the sensor mounting method.  
Z method - V method

**(9) Analog over-scale**

Over-scale of analog output

- Change the range setting. Refer to analog input/output setting.

**(10) Backup failure**

- Backup battery power is lost. The battery needs to be replaced. Contact our office for replacement.
- Measurement can be made but data backup cannot be made. Error is cleared when it passes through this panel.

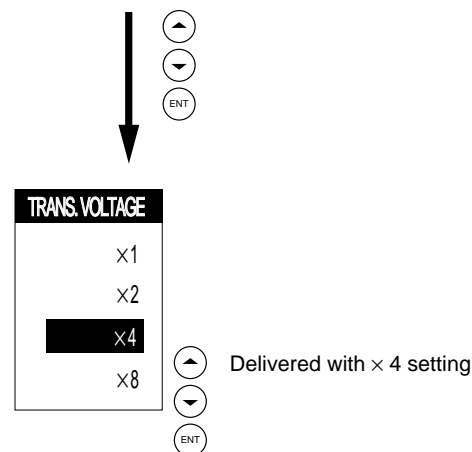

## 6.5 Measurement of Fluid with Unknown Sonic Speed

(operation after inputting the piping input/output specifications)

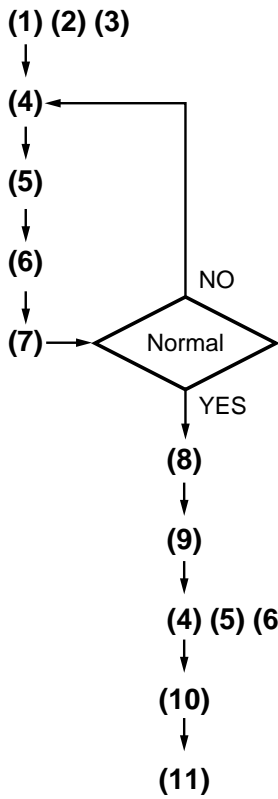
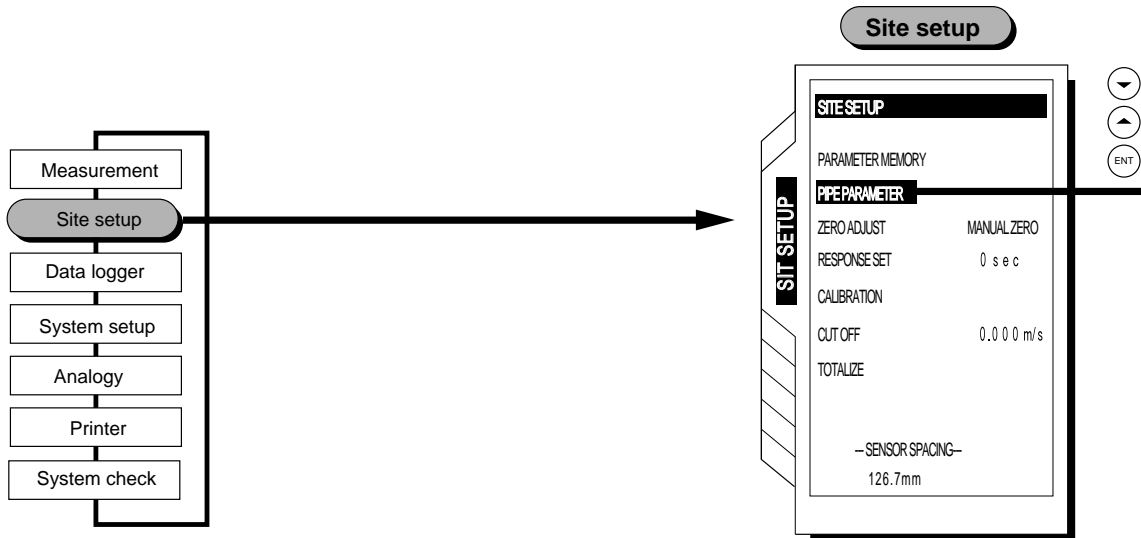

### (4) Measurement of unknown fluid

Temporarily set the sonic speed and the coefficient of kinematic viscosity of an approximate fluid (water soluble fluid is regarded as water), and obtain a measured value of sonic speed. If the sonic speed is not known at all, temporarily set the sonic speed by the following steps within the range 500 to 2500m/s.

$\times 0.84 \quad \times 0.84$   
 2500 → 2100 → 1764 → 1482 → 1245 → 1046 → 878 → 738 → 620 → 521m/s

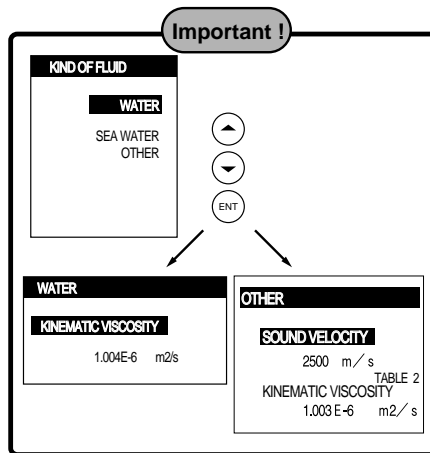

Table 2: Coefficient of kinematic viscosity of various fluids

Fluid name	T:°C	p: g/cm <sup>3</sup>	V: m/s	v: (x10 <sup>-6</sup> m <sup>2</sup> /s)
Acetone	20	0.7905	1190	0.407
Aniline	20	1.0216	1659	1.762
Ether	20	0.7135	1006	0.336
Ethylene glycol	20	1.1131	1666	21.112
Chloroform	20	1.4870	1001	0.383
Glycerin	20	1.2613	1923	1188.500
Acetic acid	20	1.0495	1159	1.162
Methyl acetate	20	0.9280	1181	0.411
Ethyl acetate	20	0.9000	1164	0.499
Heavy water	20	1.1053	1388	1.129
Carbon tetrachloride	20	1.5942	938	0.608
Mercury	20	13.5955	1451	0.114
Nitrobenzene	20	1.2070	1473	1.665
Carbon bisulfide	20	1.2634	1158	0.290
n. pentane	20	0.6260	1032	0.366
n. hexane	20	0.6540	1083	0.489
Spindle oil	32	0.9050	1324	15.700
Gasoline	34	0.8030	1250	0.4-0.5
Water	13.5	1.0000	1460	1.004 (20°C)

T: Temperature p: Density V: Sonic speed  
 v: Coefficient of kinematic viscosity

Note) For other fluids, see "DATA" given in Chapter 8.

### Description of key symbols

- : ENTRY key (data registration)
- : ESCAPE key (setting suspension)
- : Cursor up-shift (set value feed)
- : Cursor down-shift (set value return)
- : Cursor left-shift (scale change)
- : Cursor right-shift (scale change)
- : Display screen printout (hard copy)

### (9) Setting of "Sonic speed" and "Coefficient of kinematic viscosity" of unknown fluid

- Open "SITE SETUP" page.
- Change the setting from "Kind of fluid" to "Other".

### Important !

- 1) Fluid sonic speed: Set m/s in Item (8) .
- 2) Coefficient of kinematic viscosity: Referring to Table 1 "Coefficient of kinematic viscosity", set the coefficient of kinematic viscosity of an unknown fluid approximate to the fluid name (kind of fluid). (Note that this is not the coefficient of kinematic viscosity of fluid approximate to the sonic speed of the measured fluid.)

**Piping setting**

For details, refer to the piping input specifications (Page 6).

**(1) Selection of sensor mounting method**

In general, the V method is used. But, the Z method is used in the following cases.

- \* Mounting space cannot be obtained.
- \* High turbidity
- \* Weak receiving wave
- \* Deposit of thick scale inside the piping

**(2) Kind of sensor**

**(3) Transmission voltage**

**Important !**  
Setting prior to delivery: x4

**(5) Display of mounting size**

Error of 1mm deviation at  $\phi 50$ : About 1%.  
Error of 1mm deviation at  $\phi 500$ : About 0.1%

**(6) Mounting of sensor**

Refer to page 7 .

**(7) Starting the flow measurement**

- No received signal
- Window scan
- Received signal overflow

When the above errors appear, repeat (4), (5), (6) procedures until it becomes "Normal".

- Measurement panel status display → "Normal"
- More than 2 indicators are "ON" on the upper right of the screen.

**(8) Opening the system check panel**

- 1) Select "Signal check".
- 2) Read measured value  $\square \times \square \square \text{ m/s}$  of "Fluid sonic speed" on the upper side of the panel.

**(10) Stopping the flow for zero adjustment**

**(11) Starting the flow measurement**

Stop the flow and perform zero adjustment.

**Important !**  
**Measurement accuracy**  
Fluid sonic speed is entered approximately so the measurement accuracy is almost the same as "Accuracy of fluid with known sonic speed". But, the accuracy is slightly worse to the extent that the coefficient of kinematic viscosity is not actual but approximate.

## 7. Q & A

---

### 7.1 How is piping setting made when piping specifications are unknown ?

Flow rate can be measured within the range of the specifications of PORTAFLOW X by entering the standard value, but the accuracy cannot be guaranteed.

- \* Outer diameter can be confirmed by measuring the outside circumference.
- \* Thickness can be confirmed by using a piping thickness gauge available optionally.
- \* Lining material and its thickness can generally be estimated from the above-mentioned specifications and the standard specifications.

### 7.2 What is the effect of coating outside the piping ?

In general, when the outside wall of the piping is rusted and contaminated with deposits of foreign objects, coating materials, etc., so the sensor is not fitted firmly to the piping, measurement cannot be made if there is an air gap which prevents the passage of ultrasonic waves.

In this case, the sensor should be mounted after removing the contamination.

Measurement at a point with uniform coating can be made without problems.

There are no problems with a thick coating (more than several mm), but the measurement accuracy can be improved by adding the lining thickness to the coating thickness and entering it prior to measurement.

When wrapped with jute, the jute should be removed before measurement.

### 7.3 What is the effect of scales in the piping ?

Measurement can be made even when there are scales in the piping, but the amount of reduction of the sectional area due to scaling will become an error.

Therefore, the flow indicated is a little larger than the actual flow.

When the scale thickness is known, it can be compensated by adding it to the lining thickness and entering it for measurement. In general, the state of deposit of scales in old piping is not uniform, and shows an uneven surface. Therefore, an accurate cross-sectional area of flow passage cannot be measured.

Also, the flow profile is not uniform, and an accurate measurement of flow cannot be expected, strictly speaking.

### 7.4 What is homogenous fluid through which ultrasonic waves are transmitted ?

Municipal water can be measured over the range from raw water to clean water without problems.

Sewage flows can be measured up to return sludge.

If the flow contains many air bubbles, it cannot be measured. In general, the less foreign objects (including air bubbles) the flow contains, the more easily can it be measured.

## 7.5 Is it possible to measure the flow in piping that is not full?

In horizontal piping, if the pipe is filled with liquid up to  $2/3$  of inside diameter  $D$  as shown below, the flow velocity can be measured. In this case, the flow rate indicated is the assumed one under filled pipe conditions.

Therefore, the flow indicated is larger than the actual flow.

If sludge is accumulated on the bottom of the piping, the flow velocity can be measured up to  $1/3$  of inside diameter  $D$ . In this case, the flow rate indicated is the assumed one under filled pipe conditions without any sludge.

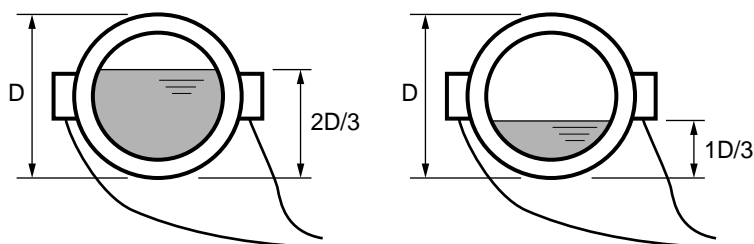

## 7.6 What happens when the liquid contains air bubbles ?

When liquid contains excessive air bubbles, no measurement can be made because of transmission failure of the ultrasonic waves. When air bubbles enter the liquid momentarily, the output is retained by the self-check function, thereby causing no problems. Air bubbles easily enter liquid in the following cases.

- (1) Suction of air due to low liquid level of pump well
- (2) Occurrence of cavitation
- (3) Pressure in the piping becomes negative and air enters from piping connection.

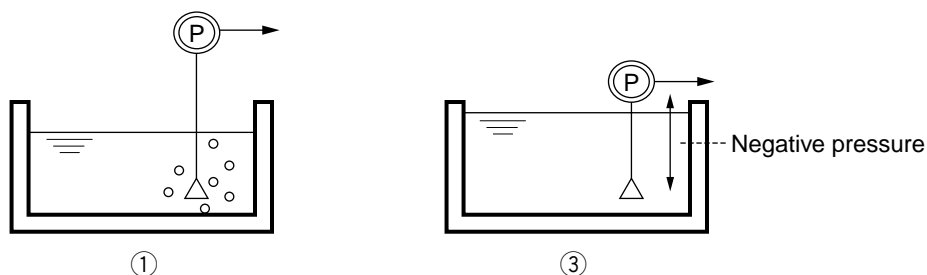

### 7.7 What about mounting the sensor on horizontal piping ?

The sensor should be mounted in the horizontal direction on the piping circumference to prevent the effects of accumulated sludge (lower) and air bubbles (upper).

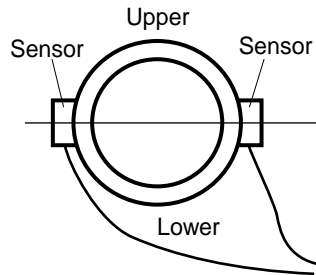

### 7.8 What about mounting the sensor on vertical piping ?

The sensor can be mounted on any external position of vertical piping.

The recommendable flow direction is upward to avoid the interference of bubbles.

### 7.9 When the length of straight piping is short and a pump, valve, orifice, etc. is present, what is required for measurement ?

In general, the length of straight piping on upstream side should be longer than 10D, and that on downstream side should be longer than 5D. When a pump, valve, orifice, etc. is present, measurement should be made at a location greater than 30D away on the upstream side and greater than 5D away on the downstream side. (See page 3 for detail.)

### 7.10 How far can the sensor extension cord be extended ?

Extension cords can be connected and extended up to 100m.

(Special cable with BNC connector: 10m x 2 or 50m x 2 available optionally)



## 7.11 What is the approximate accuracy of measurement ?

Specifications:

Inside diameter	Flow velocity	Accuracy
φ13 to φ50 or less	2 to 32 m/s	±1.5% of measured flow
	0 to 2 m/s	±0.03 m/s* <sup>1</sup>
φ50 to φ300 or less	2 to 32 m/s	±1.0% of measured flow
	0 to 2 m/s	±0.02 m/s
φ300 to φ6000	1 to 32 m/s	±1.0% of measured flow
	0 to 1 m/s	±0.01 m/s

\*1: Example of calculation

$$\text{Error at 2m/s?} \rightarrow \pm 0.03 \times 100/2 = \pm 1.5\%$$

$$\text{Error at 1m/s?} \rightarrow \pm 0.03 \times 100/1 = \pm 3.0\%$$

Formerly, the expression ○○% of full scale was often used. But, in the recent age of digital system, it is more frequently expressed in % of the displayed value. Under the condition of low flow velocity, the absolute value of error is used as a standard of accuracy in consideration of the threshold of device performance.

## 7.12 What about error factors ?

On PORTAFLOW X, ultrasonic waves are emitted from the outside of the piping and the time is measured while the waves are passing through the piping material - fluid - piping material. Therefore, the flow coefficient is determined according to the piping material, size and the angle of propagation of sound waves. As mentioned on the previous page, the following points become the error factors to be considered when evaluating the measured values.

### (1) Piping size

When the value set for piping size is different from the actual size of piping, and if the difference from the inside diameter is about 1% in size, the error is about 3% of deviation obtained by flow conversion.

(The following shows an example of 1mm deviation in inside diameter)

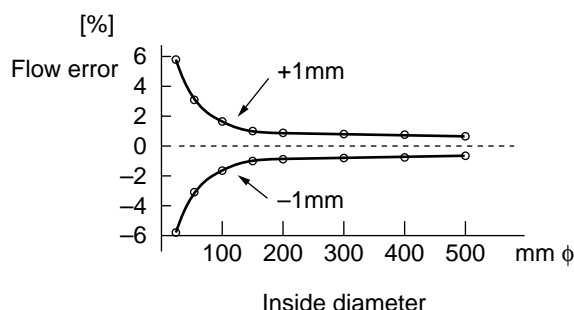

**(2) Difference in sensor mounting length**

As a general standard, when the error in mounting length is  $\pm 1\text{mm}$ , the error of flow is within 1%.

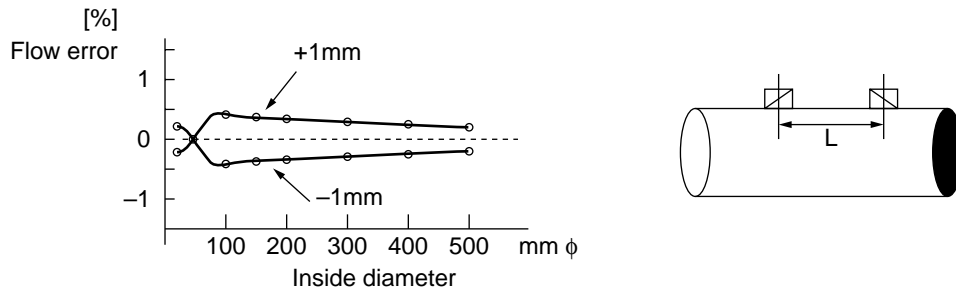

**(3) Flow in piping is deviated**

When the straight piping is short (particularly upstream side), the flow has become skewed and some deviation error will occur, or fluctuation of indicated value will occur when the flow is swirling.

**(4) Inside diameter different from set value due to deposits of scales inside the piping**

The error is the same as noted in 1). If scales are badly deposited, receiving waves are not available and measurement may be disabled.

**(5) Change in water temperature**

Temperature is compensated, but there is a slight error when temperature changes.

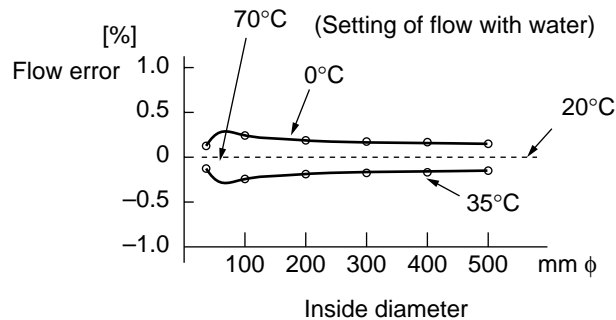

**(6) Weak received wave due to improper mounting condition and piping condition**

Measurement may be possible. But, if received wave is weak, it may result in a large error due to the effect of external noise.

---

## 7.13 What about comparison with other flowmeters ?

Although thermometers and pressure gauges can easily be calibrated at a site, flowmeters are generally very difficult to calibrate at a site.

Therefore, PORTAFLOW X is often used for checking other flowmeters. After checking, the result of comparison of flowmeters should be evaluated with care while considering to the following points.

### (1) Consideration of error of each flowmeter

In case of 5000m<sup>3</sup>/h full-scale flowmeter with performance of  $\pm 1\%$  full-scale, an error of  $\pm 5\text{m}^3/\text{h}$  can be considered at any range.

The error of PORTAFLOW X should also be added when evaluating the total error.

When the error range is the same for both the result of the check is considered normal.

### (2) Study data systematically, if an error is found.

Check points of flowmeter are the following 3 factors.

- (1) Zero point
- (2) Span (flow range)
- (3) Linearity

Do not compare values only at 1 point of flow. Draw many samples on a graph and arrange them systematically. Determine the error in the above 3 points and perform calibrations.

### (3) Thoroughly check the piping system.

If fluid flows into or out of a branch pipe in the middle of a piping system, the comparison data of each side of such a pipe-junction may not match each other.

When there is storage in the middle of piping system and it becomes a buffer for the flow, the liquid level of the storage area should be taken into consideration.

### (4) Comparison of 2 different sets of flowmeters is difficult.

When there is a difference between 2 sets of flowmeters, it is difficult to judge the correct one.

So, another judgement criteria needs to be considered.

## 7.14 What is the difference between a Doppler type flowmeter and PORTAFLOW X?

A Doppler type flowmeter emits ultrasonic waves and receives the waves reflected from foreign objects in the fluid.

Velocity is measured utilizing the principle that the frequency deviation of the received waves from the emitted ones is in proportion to the flow velocity (Doppler effect).

Therefore:

- (1) The fluid must contain foreign objects (including air bubbles). It is not suited for clean water but is suited for sewage.
- (2) Since the position in the fluid where the reflection occurs is obscure, the amount and nature of foreign objects in the fluid affect the measuring accuracy together with the velocity profile in the piping.

PORTAFLOW X is designed to measure the velocity with ultrasonic waves passing through piping. As it measures an average velocity in the piping, it measures flow rate highly accurately.

The Doppler system has the above-mentioned disadvantage, but it is used to measure an approximate flow from the outside of the piping, permits liquids with large amount of foreign objects, and is effectively used for liquids with slurry or air bubbles.

## 7.15 Life span of LCD

The life span of LCD is considered to be about 10 years under general operating conditions, according to the manufacturer's catalogue. Generally, it is about 5 to 6 years in actual service.

The life span is not so much related to the number of displaying operations.

# 8. DATA

## (1) Sonic Speed of Solid (at 25°C )

Material	Sound Speed (m/s)	Material	Sound Speed (m/s)
Steel 1% Carbon, hardened	3150	Iron(Armco)	3230
Carbon Steel	3206	Ductile Iron	3000
Mild Steel	3235	Monel	2720
Steel 1% Carbon	3220	Nickel	2960
Stainless Steel 302	3120	Tin, rolled	1670
Stainless Steel 303	3120	Titanium	3125
Stainless Steel 304	3206	Tungsten,annealed	2890
Stainless Steel 316	3175	Tungsten, drawn	2640
Stainless Steel 347	3100	Tungsten, carbide	3980
Stainless Steel 410	2990	Zinc, rolled	2440
Stainless Steel 430	3360	Glass, Pyrex	3280
Aluminum	3080	Glass, heavy silicate flint	2380
Aluminum(rolled)	3040	Glass, light borate crown	2840
Copper	2260	Nylon	2400
Copper(annealed)	2325	Nylon,6-6	1070
Copper(rolled)	2270	Polyethylene(HD)	2310
CuNi (70%Cu 30%Ni)	2540	Polyethylene(LD)	1940
CuNi (90%Cu 10%Ni)	2060	PVC, CPVC	2400
Brass(Naval)	2050	Acrylic	2730
Gold(hard-brawn)	1200	Asbestos Cement	2200
Inconel	3020	Tar Epoxy	2000
Iron(electrolytic)	3240	Mortar	2500
Cast Iron	3230	Rubber	1900
Lead	2170	FRP	2505
Teflon	1240		

## (2) Sonic Speed of Water

Temperature (°C)	Sound Speed (m/s)	Temperature (°C)	Sound Speed (m/s)
0	1402.74	52	1544.95
2	1412.57	54	1546.83
4	1421.96	56	1548.51
6	1430.92	58	1550.00
8	1439.46	60	1551.30
10	1447.59	62	1552.42
12	1455.34	64	1553.35
14	1462.70	66	1554.11
16	1469.70	68	1554.70
18	1476.35	70	1555.12
20	1482.66	72	1555.37
22	1488.63	74	1555.47
24	1494.29	76	1555.40
26	1499.64	78	1555.18
28	1504.68	80	1554.81
30	1509.44	82	1554.30
32	1513.91	84	1553.63
34	1518.12	86	1552.82
36	1522.06	88	1551.88
38	1525.74	90	1550.79
40	1529.18	92	1549.58
42	1532.37	94	1548.23
44	1535.33	96	1546.75
46	1538.06	98	1545.14
48	1540.57	100	1543.41
50	1542.84		

## (3) Sonic Speed of Fluid

1/4

Substance	Form Index	Temp. (°C)	Sound Speed (m/s)	Kinematic Viscosity (m <sup>2</sup> /s × 10 <sup>-6</sup> )
Acetic acid	CH <sub>3</sub> COOH	20	1159	
Acetic anhydride	(CH <sub>3</sub> CO) <sub>2</sub> O	20	1180	0.769
Acetic acid, anhydride	(CH <sub>3</sub> CO) <sub>2</sub> O	20	1180	0.769
Acetonitrile	C <sub>2</sub> H <sub>3</sub> N	25	1290	0.441
Ethyl acetate	C <sub>4</sub> H <sub>8</sub> O <sub>2</sub>	25	1085	0.467
Methyl acetate	C <sub>3</sub> H <sub>6</sub> O <sub>2</sub>	25	1211	0.407
Acetone	C <sub>3</sub> H <sub>6</sub> O	20	1190	0.407
Acetonitrile	C <sub>2</sub> H <sub>3</sub> N	25	1290	0.441
Acetonylacetone	C <sub>6</sub> H <sub>10</sub> O <sub>2</sub>	25	1399	
Acetylene dichloride	C <sub>2</sub> H <sub>2</sub> Cl <sub>2</sub>	25	1015	0.400
Acetylene tetrabromide	C <sub>2</sub> H <sub>2</sub> Br <sub>4</sub>	25	1027	
Acetylene tetrachloride	C <sub>2</sub> H <sub>2</sub> Cl <sub>4</sub>	25	1147	1.156 (15°C)
Ethyl alcohol	C <sub>2</sub> H <sub>6</sub> O	25	1207	1.396
Alkazene-13	C <sub>15</sub> H <sub>24</sub>	25	1317	
Alkazene-25	C <sub>10</sub> H <sub>12</sub> Cl <sub>2</sub>	25	1307	
2-amino-ethanol	C <sub>2</sub> H <sub>7</sub> NO	25	1724	
2-aminotolidine	C <sub>7</sub> H <sub>9</sub> N	25	1618	4.394 (20°C)
4-aminotolidine	C <sub>7</sub> H <sub>9</sub> N	25	1480	1.863 (50°C)
Ammonia	NH <sub>3</sub>	-33	1729	0.292
t-amyl alcohol	C <sub>5</sub> H <sub>12</sub> O	25	1204	4.374
Aminobenzene	C <sub>6</sub> H <sub>5</sub> NO <sub>2</sub>	25	1639	3.63
Aniline	C <sub>6</sub> H <sub>5</sub> NO <sub>2</sub>	20	1659	1.762
Azine	C <sub>6</sub> H <sub>5</sub> N	25	1415	0.992
Benzene	C <sub>6</sub> H <sub>6</sub>	25	1306	0.711
Benzol	C <sub>6</sub> H <sub>6</sub>	25	1306	0.711
Bromine	Br <sub>2</sub>	25	889	0.323
Bromobenzene	C <sub>6</sub> H <sub>5</sub> Br	25	1170	0.693
1-bromo-butane	C <sub>4</sub> H <sub>9</sub> Br	20	1019	0.49 (15°C)
Bromoethane	C <sub>2</sub> H <sub>5</sub> Br	20	900	0.275
Bromoform	CHBr <sub>3</sub>	20	918	0.654
n-butane	C <sub>4</sub> H <sub>10</sub>	-5	1085	
2-butanol	C <sub>4</sub> H <sub>10</sub> O	25	1240	3.239
sec-butylalcohol	C <sub>4</sub> H <sub>10</sub> O	25	1240	3.239
n-butyl bromide	C <sub>4</sub> H <sub>9</sub> Br	20	1019	0.49 (15°C)
n-butyl chloride	C <sub>4</sub> H <sub>9</sub> Cl	25	1140	0.529
tert butyl chloride	C <sub>4</sub> H <sub>9</sub> Cl	25	984	0.646
Butyl oleate	C <sub>22</sub> H <sub>42</sub> O <sub>2</sub>	25	1404	0.529
2,3 butylene glycol	C <sub>4</sub> H <sub>10</sub> O <sub>2</sub>	25	1484	
Carbinol	CH <sub>4</sub> O	25	1076	0.695
Carbitol	C <sub>6</sub> H <sub>14</sub> O <sub>3</sub>	25	1458	
Carbon dioxide	CO <sub>2</sub>	-37	839	0.137

Substance	Form Index	Temp. (°C)	Sound Speed (m/s)	Kinematic Viscosity (m <sup>2</sup> /s × 10 <sup>-6</sup> )
Carbon dioxide	CO <sub>2</sub>	-37	839	0.137
Carbon disulphide	CS <sub>2</sub>	20	1158	0.290
Carbon tetrachloride	CCl <sub>4</sub>	20	938	0.608
Cetane	C <sub>16</sub> H <sub>34</sub>	20	1338	4.32
Chlorobenzene	C <sub>6</sub> H <sub>5</sub> Cl	20	1289	0.722 (25°C)
1-Chlorobutane	C <sub>4</sub> H <sub>9</sub> Cl	25	1140	0.529
Chloroform	CHCl <sub>3</sub>	20	931	0.383
1-chloropropane	C <sub>3</sub> H <sub>7</sub> Cl	25	1058	0.378
Cinnamaldehyde	C <sub>9</sub> H <sub>8</sub> O	25	1554	
Cinnamic aldehyde	C <sub>9</sub> H <sub>8</sub> O	25	1554	
Colamine	C <sub>2</sub> H <sub>7</sub> NO	25	1724	
o-cresol	C <sub>7</sub> H <sub>8</sub> O	20	1541	4.29 (40°C)
m-cresol	C <sub>7</sub> H <sub>8</sub> O	20	1500	5.979 (40°C)
Cyanomethane	C <sub>2</sub> H <sub>3</sub> N	25	1290	0.441
Cyclohexane	C <sub>6</sub> H <sub>12</sub>	20	1284	1.31 (17°C)
Cyclohexanol	C <sub>6</sub> H <sub>12</sub> O	25	1454	0.071 (17°C)
Cyclohexanone	C <sub>6</sub> H <sub>10</sub> O	25	1423	
Decane	C <sub>10</sub> H <sub>22</sub>	25	1252	1.26 (20°C)
1-decene	C <sub>10</sub> H <sub>20</sub>	25	1235	
n-decylene	C <sub>10</sub> H <sub>20</sub>	25	1235	
Diacetyl	C <sub>4</sub> H <sub>6</sub> O <sub>2</sub>	25	1236	
Diamylamine	C <sub>10</sub> H <sub>23</sub> N	25	1256	
1, 2-dibromo-ethane	C <sub>2</sub> H <sub>4</sub> Br <sub>2</sub>	25	995	0.79 (20°C)
trans-1, 2-dibromoethene	C <sub>2</sub> H <sub>2</sub> Br <sub>2</sub>	25	935	
Dibutyl phthalate	C <sub>6</sub> H <sub>22</sub> O <sub>4</sub>	25	1408	
Dichloro-t-butyl alcohol	C <sub>4</sub> H <sub>8</sub> Cl <sub>2</sub> O	25	1304	
2, 3-dichlorodixane	C <sub>2</sub> H <sub>6</sub> Cl <sub>2</sub> O <sub>2</sub>	25	1391	
dichlorodi-fluoromethane (Freon 12)	CCl <sub>2</sub> F <sub>2</sub>	25	774.1	
1, 2-dichloro ethane	C <sub>2</sub> H <sub>4</sub> Cl <sub>2</sub>	25	1193	0.61
cis1, 2-dichloro-ethane	C <sub>2</sub> H <sub>2</sub> Cl <sub>2</sub>	25	1061	
trans 1, 2-dichloro-ethane	C <sub>2</sub> H <sub>2</sub> Cl <sub>2</sub>	25	1010	
Dichlorofluoro-methane (Freon21)	CHCl <sub>2</sub> F	0	891	
1-2-dichlorohexa-fluorocyclobutane	C <sub>4</sub> Cl <sub>2</sub> F <sub>6</sub>	25	669	
1-3-dichloro-isobutane	C <sub>4</sub> H <sub>8</sub> Cl <sub>2</sub>	25	1220	

Substance	Form Index	Temp. (°C)	Sound Speed (m/s)	Kinematic Viscosity (m <sup>2</sup> /s × 10 <sup>-6</sup> )	Substance	Form Index	Temp. (°C)	Sound Speed (m/s)	Kinematic Viscosity (m <sup>2</sup> /s × 10 <sup>-6</sup> )
Dichloro methane	CH <sub>2</sub> Cl <sub>2</sub>	25	1070	0.31	Ethanol	C <sub>2</sub> H <sub>6</sub> O	25	1207	1.39
1, 1-dichloro- 1, 2, 2, 2-tetra fluoroethane	CClF <sub>2</sub> -CClF <sub>2</sub>	25	665.3		Ethanol amide	C <sub>2</sub> H <sub>7</sub> NO	25	1724	
Diethyl ether	C <sub>4</sub> H <sub>10</sub> O	25	985	0.311	Ethoxyethane	C <sub>4</sub> H <sub>10</sub> O	25	985	0.311
Diethylene glycol	C <sub>4</sub> H <sub>10</sub> O <sub>3</sub>	25	1586		Ethyl acetate	C <sub>4</sub> H <sub>8</sub> O <sub>2</sub>	20	1164	0.499
Diethylene glycol, monoethyl ether	C <sub>6</sub> H <sub>14</sub> O <sub>3</sub>	25	1458		Ethyl alcohol	C <sub>2</sub> H <sub>6</sub> O	25	1207	1.396
Diethylenimide oxide	C <sub>4</sub> H <sub>9</sub> NO	25	1442		Ethyl benzene	C <sub>8</sub> H <sub>10</sub>	20	1338	0.797(17°C)
1, 2-bis (difluoramino) butane	C <sub>4</sub> H <sub>8</sub> (NF <sub>2</sub> ) <sub>2</sub>	25	1000		Ethyl Bromide	C <sub>2</sub> H <sub>5</sub> Br	20	900	0.275
1, 2-bis (difluoramino)- 2-methylpropane	C <sub>4</sub> H <sub>9</sub> (NF <sub>2</sub> ) <sub>2</sub>	25	900		Ethyl iodide	C <sub>2</sub> H <sub>5</sub> I	20	876	0.29
1, 2-bis (difluoramino) propane	C <sub>3</sub> H <sub>6</sub> (NF <sub>2</sub> ) <sub>2</sub>	25	960		Ether	C <sub>4</sub> H <sub>10</sub> O	20	1006	0.336
2, 2-bis (difluoramino) propane	C <sub>3</sub> H <sub>6</sub> (NF <sub>2</sub> ) <sub>2</sub>	25	890		Ethyl ether	C <sub>4</sub> H <sub>10</sub> O	25	985	0.311
2, 2-dihydroxy- dilethyrther	C <sub>4</sub> H <sub>10</sub> O <sub>3</sub>	25	1586		Ethylene bromide	C <sub>2</sub> H <sub>4</sub> Br <sub>2</sub>	25	995	0.79
Dihydroxyethane	C <sub>2</sub> H <sub>6</sub> O <sub>2</sub>	25	1658		Ethylene chloride	C <sub>2</sub> H <sub>4</sub> Cl <sub>2</sub>	25	1193	0.61
1, 3-dimethyl- benzene	C <sub>8</sub> H <sub>10</sub>	20	1343	0.749 (15°C)	Ethylene glycol	C <sub>2</sub> H <sub>6</sub> O <sub>2</sub>	20	1666	21.112
1, 2-dimethyl- benzene	C <sub>8</sub> H <sub>10</sub>	25	1331.5	0.903 (20°C)	50% glycol/ 50% H <sub>2</sub> O		25	1578	
1, 4-dimethyl- benzene	C <sub>8</sub> H <sub>10</sub>	20	1334	0.662	d-fenochone	C <sub>10</sub> H <sub>16</sub> O	25	1320	0.22
2,2-dimethyl- butane	C <sub>6</sub> H <sub>14</sub>	25	1079		d-2- fenochone	C <sub>10</sub> H <sub>16</sub> O	25	1320	0.22
Dimethyl ketone	C <sub>3</sub> H <sub>6</sub> O	25	1174	0.399	Fluoro-benzene (46)	C <sub>6</sub> H <sub>5</sub> F	25	1189	0.584
Dimethyl pentane (47)	C <sub>7</sub> H <sub>16</sub>	25	1063		Formaldehyde, methylester	C <sub>2</sub> H <sub>4</sub> O <sub>2</sub>	25	1127	
Dimethyl phthalate	C <sub>8</sub> H <sub>10</sub> O <sub>4</sub>	25	1463		Formamide	CH <sub>3</sub> NO	25	1622	2.91
Diiodo-methane	CH <sub>2</sub> I <sub>2</sub>	25	980		Formic acid, amide	CH <sub>3</sub> NO	25	1622	2.91
Dioxane	C <sub>4</sub> H <sub>8</sub> O <sub>2</sub>	25	1376		Freon R12		25	774.2	
Dodecane (23)	C <sub>12</sub> H <sub>26</sub>	25	1279	1.80	Furfural	C <sub>5</sub> H <sub>4</sub> O <sub>2</sub>	25	1444	
1, 2-ethanediol	C <sub>2</sub> H <sub>6</sub> O <sub>2</sub>	25	1658		Furfuryl alcohol	C <sub>5</sub> H <sub>6</sub> O <sub>2</sub>	25	1450	
Ethanenitrile	C <sub>2</sub> H <sub>3</sub> N	25	1290	0.441	Fural	C <sub>5</sub> H <sub>4</sub> O <sub>2</sub>	25	1444	
Ethanoic anhydride (22)	(CH <sub>3</sub> CO) <sub>2</sub> O	25	1180	0.769	2-furaldehyde	C <sub>5</sub> H <sub>4</sub> O <sub>2</sub>	25	1444	
					2-furancarboxalde- hyde	C <sub>5</sub> H <sub>4</sub> O <sub>2</sub>	25	1444	
					2-furyl-methanol	C <sub>5</sub> H <sub>6</sub> O <sub>2</sub>	25	1450	
					Gallium	Ga	30	2870	
					Glycerin	C <sub>3</sub> H <sub>8</sub> O <sub>3</sub>	20	1923	1188.5
					Glycerol	C <sub>3</sub> H <sub>8</sub> O <sub>3</sub>	25	1904	757.1
					Glycol	C <sub>2</sub> H <sub>6</sub> O <sub>2</sub>	25	1658	
					Heptane	C <sub>7</sub> H <sub>16</sub>	25	1131	0.598(20°C)
					n-heptane	C <sub>7</sub> H <sub>16</sub>	25	1180	
					Hexachloro- cyclopentadiene	C <sub>5</sub> Cl <sub>6</sub>	25	1150	
					Hexadecane	C <sub>16</sub> H <sub>34</sub>	25	1338	4.32(20°C)
					Hexalin	C <sub>16</sub> H <sub>12</sub>	25	1454	70.69(17°C)
					Hexane	C <sub>6</sub> H <sub>14</sub>	25	1112	0.446
					n-hexane	C <sub>6</sub> H <sub>14</sub>	20	1083	0.489
					2, 5-hexanedione	C <sub>6</sub> H <sub>10</sub> O <sub>2</sub>	25	1399	
					n-hexanol	C <sub>6</sub> H <sub>14</sub> O	25	1300	

Substance	Form Index	Temp. (°C)	Sound Speed (m/s)	Kinematic Viscosity (m <sup>2</sup> /s × 10 <sup>-6</sup> )
Hexahydrobenzene	C <sub>6</sub> H <sub>12</sub>	25	1248	1.31(17°C)
Hexahydrophenol	C <sub>6</sub> H <sub>12</sub> O	25	1454	
Hexamethylene	C <sub>6</sub> H <sub>12</sub>	25	1248	1.31
2-hydroxy-toluene	C <sub>7</sub> H <sub>8</sub> O	20	1541	4.29 (40°C)
3-hydroxy-toluene	C <sub>7</sub> H <sub>8</sub> O	20	1500	5.979 (40°C)
Iodo-benzene	C <sub>6</sub> H <sub>5</sub> I	20	1114	0.954
Iodo-ethane	C <sub>2</sub> H <sub>5</sub> I	20	876	0.29
Iodo-methane	CH <sub>3</sub> I	25	978	0.211
Isobutyl acetate	C <sub>6</sub> H <sub>12</sub> O	27	1180	
Isobutanol	C <sub>4</sub> H <sub>10</sub> O	25	1212	
Iso-butane		25	1219.8	0.34
Isopentane	C <sub>5</sub> H <sub>12</sub>	25	980	0.34
Isopropanol (46)	C <sub>3</sub> H <sub>8</sub> O	20	1170	2.718
Isopropyl alcohol	C <sub>3</sub> H <sub>8</sub> O	20	1170	2.718
Kerosene		25	1324	
Ketohexamethylene	C <sub>6</sub> H <sub>10</sub> O	25	1423	
Mercury	Hg	20	1451	0.114
Mesityloxide	C <sub>6</sub> H <sub>16</sub> O	25	1310	
Methanol	CH <sub>4</sub> O	25	1076	0.695
Methyl acetate	C <sub>3</sub> H <sub>6</sub> O <sub>2</sub>	20	1181	0.411
o-methylaniline	C <sub>7</sub> H <sub>7</sub> N	25	1618	4.394 (20°C)
4-methylaniline	C <sub>7</sub> H <sub>7</sub> N	25	1480	1.863 (50°C)
Methyl alcohol	CH <sub>4</sub> O	25	1076	0.695
Methyl benzene	C <sub>7</sub> H <sub>8</sub>	20	1328	0.644
2-methyl-butane	C <sub>5</sub> H <sub>12</sub>	25	980	0.34
Methyl carbinol	C <sub>2</sub> H <sub>6</sub> O	25	1207	1.396
Methyl-chloroform	C <sub>2</sub> H <sub>3</sub> Cl <sub>3</sub>	25	985	0.902 (20°C)
Methyl-cyanide	C <sub>2</sub> H <sub>3</sub> N	25	1290	0.441
3-methyl cyclohexanol	C <sub>7</sub> H <sub>14</sub> O	25	1400	
Methylene chloride	CH <sub>2</sub> Cl <sub>2</sub>	25	1070	0.31
Methylene iodide	CH <sub>2</sub> I <sub>2</sub>	25	980	
Methyl formate	C <sub>2</sub> H <sub>4</sub> O <sub>2</sub>	25	1127	
Methyl iodide	CH <sub>3</sub> I	25	978	0.211
α-methyl naphthalene	C <sub>11</sub> H <sub>10</sub>	25	1510	
2-methylphenol	C <sub>7</sub> H <sub>8</sub> O	20	1541	4.29 (40°C)
3-methylphenol	C <sub>7</sub> H <sub>8</sub> O	20	1500	5.979 (40°C)
Milk, homogenized		25	1548	
Morpholine	C <sub>4</sub> H <sub>9</sub> NO	25	1442	
Naphtha		25	1225	
Nitrobenzene	C <sub>6</sub> H <sub>5</sub> NO <sub>2</sub>	20	1473	1.665
Nitromethane	CH <sub>3</sub> NO <sub>2</sub>	25	1300	0.549
Nonane	C <sub>9</sub> H <sub>20</sub>	25	1207	0.99(20°C)
1-nonene	C <sub>9</sub> H <sub>18</sub>	25	1207	

Substance	Form Index	Temp. (°C)	Sound Speed (m/s)	Kinematic Viscosity (m <sup>2</sup> /s × 10 <sup>-6</sup> )
Octane	C <sub>8</sub> H <sub>18</sub>	25	1172	0.73
n-octane	C <sub>8</sub> H <sub>18</sub>	20	1192	0.737(25°C)
1-octene	C <sub>8</sub> H <sub>16</sub>	25	1175.5	
Oil of camphor		25	1390	
Sassafrassy				
Oil, car(SAE 20a.30)		25	870	190
Oil, castor	C <sub>11</sub> H <sub>10</sub> O <sub>10</sub>	25	1477	0.670
Oil, diesel		25	1250	
Oil, fuel AA gravity		25	1485	
Oil (Lubricating X200)		25	1530	
Oil (olive)		25	1431	100
Oil (peanut)		25	1458	
Oil (sperm)		25	1440	
Oil, 6		22	1509	
2, 2-oxidiethanol	C <sub>4</sub> H <sub>10</sub> O <sub>3</sub>	25	1586	
Pentachloroethane	C <sub>2</sub> HCl <sub>5</sub>	25	1082	
Pentalin	C <sub>2</sub> HCl <sub>5</sub>	25	1082	
Pentane	C <sub>5</sub> H <sub>12</sub>	25	1020	0.363
n-pentane	C <sub>5</sub> H <sub>12</sub>	20	1032	0.366
Perchlorocyclo-pentadiene	C <sub>5</sub> Cl <sub>6</sub>	25	1150	
Perchloroethylene	C <sub>2</sub> Cl <sub>4</sub>	25	1036	
Perchloro-1-hepten	C <sub>7</sub> F <sub>14</sub>	25	583	
Perfluoro-n-hexane	C <sub>6</sub> F <sub>14</sub>	25	508	
Phene	C <sub>6</sub> H <sub>6</sub>	25	1306	0.711
β-phenyl acrolein	C <sub>9</sub> H <sub>8</sub> O	25	1554	
Phenyl amine	C <sub>6</sub> H <sub>5</sub> NO <sub>2</sub>	25	1639	3.63
Phenyl bromide	C <sub>6</sub> H <sub>5</sub> Br	20	1170	0.693
Phenyl chloride	C <sub>6</sub> H <sub>5</sub> Cl	25	1273	0.722
Phenyl iodide	C <sub>6</sub> H <sub>5</sub> I	20	1114	0.954(15°C)
Phenyl methane	C <sub>7</sub> H <sub>8</sub>	20	1328	0.644
3-Phenyl propenal	C <sub>9</sub> H <sub>8</sub> O	25	1554	
Phthalardione	C <sub>8</sub> H <sub>4</sub> O <sub>3</sub>	152	1125	
Pimelic ketone	C <sub>6</sub> H <sub>10</sub> O	25	1423	
Plexiglas, lucite, acrylic		25	2651	
Refrigerant 11	CCl <sub>3</sub> F	0	828.3	
Propane	C <sub>3</sub> H <sub>8</sub>	-45	1003	
1, 2, 3-propanetriol	C <sub>3</sub> H <sub>8</sub> O <sub>3</sub>	25	1904	0.757×10 <sup>-3</sup>
1-propanol	C <sub>3</sub> H <sub>8</sub> O	20	1222	
2-propanol	C <sub>3</sub> H <sub>8</sub> O	20	1170	2.718
2-propanone	C <sub>3</sub> H <sub>6</sub> O	25	1174	0.399
Propene	C <sub>3</sub> H <sub>6</sub>	-13	963	
n-propyl acetate	C <sub>5</sub> H <sub>10</sub> O <sub>2</sub>	2	1280	



Substance	Form Index	Temp. (°C)	Sound Speed (m/s)	Kinematic Viscosity (m <sup>2</sup> /s × 10 <sup>-6</sup> )
n-propyl alcohol	C <sub>3</sub> H <sub>8</sub> O	20	1225	2.549
Propylchloride	C <sub>3</sub> H <sub>7</sub> Cl	25	1058	0.378
Propylene	C <sub>3</sub> H <sub>6</sub>	-13	963	
Pyridine	C <sub>6</sub> H <sub>5</sub> N	25	1415	0.992(20°C)
Refrigerant 11	CCl <sub>3</sub> F	0	828.3	
Refrigerant 12	CCl <sub>2</sub> F <sub>2</sub>	-40	774.1	
Refrigerant 21	CHCl <sub>2</sub> F	0	891	
Refrigerant 22	CHClF <sub>2</sub>	50	893.9	
Refrigerant 113	CCl <sub>2</sub> F-CClF <sub>2</sub>	0	783.7	
Refrigerant 114	CClF <sub>2</sub> -CClF <sub>2</sub>	-10	665.3	
Refrigerant 115	C <sub>2</sub> ClF <sub>5</sub>	-50	656.4	
Refrigerant C318	C <sub>4</sub> F <sub>8</sub>	-10	574	
Silicone (30cp)		25	990	30
Solvesso #3		25	1370	
Spirit of wine	C <sub>2</sub> H <sub>6</sub> O	25	1207	1.396
Sulfuric Acid	H <sub>2</sub> SO <sub>4</sub>	25	1257.6	11.16
1, 1, 2, 2-tetrabromoethane	C <sub>2</sub> H <sub>2</sub> Br <sub>4</sub>	25	1027	
1, 1, 2, 2-tetrachloroethane	C <sub>2</sub> H <sub>2</sub> Cl <sub>4</sub>	25	1147	1.156 (15°C)
Tetrachloroethane	C <sub>2</sub> H <sub>2</sub> Cl <sub>4</sub>	20	1170	1.19
Tetrachloroethene	C <sub>2</sub> Cl <sub>4</sub>	25	1036	
Tetrachloro-Methane	CCl <sub>4</sub>	25	926	0.607
Tetradecane	C <sub>14</sub> H <sub>30</sub>	20	1331	2.86
Tetraethylene glycol	C <sub>8</sub> H <sub>18</sub> O <sub>5</sub>	25	1586	
Tetrahydro-1, 4-isoxazine	C <sub>4</sub> H <sub>9</sub> NO	25	1442	
Toluene	C <sub>7</sub> H <sub>8</sub>	20	1328	0.644
o-toluidine	C <sub>7</sub> H <sub>9</sub> N	25	1618	4.394 (20°C)
p-toluidine	C <sub>7</sub> H <sub>9</sub> N	25	1480	1.863 (50°C)
Toluol	C <sub>7</sub> H <sub>8</sub>	25	1308	0.58
Tribromomethane	CHBr <sub>3</sub>	25	918	0.654
1, 1, 1-trichloroethane	C <sub>2</sub> H <sub>3</sub> Cl <sub>3</sub>	25	985	0.902 (20°C)
Trichloro-ethene	C <sub>2</sub> HCl <sub>3</sub>	25	1028	
Trichloro-fluoromethane (Freon 11)	CCl <sub>3</sub> F	0	828.3	
Trichloro-methane	CHCl <sub>3</sub>	25	979	0.55
1, 1, 2-trichloro-1, 2, 2-trifluoroethane	CCl <sub>2</sub> F-CClF <sub>2</sub>	0	783.7	
Triethylamine	C <sub>6</sub> H <sub>15</sub> N	25	1123	

Substance	Form Index	Temp. (°C)	Sound Speed (m/s)	Kinematic Viscosity (m <sup>2</sup> /s × 10 <sup>-6</sup> )
Triethylene glycol	C <sub>6</sub> H <sub>14</sub> O <sub>4</sub>	25	1608	
1, 1, 1-trifluoro-2-chloro-2-bromoethane	C <sub>2</sub> HClBrF <sub>3</sub>	25	693	
1, 2, 2-trifluorotrichloroethane (Freon 113)	CCl <sub>2</sub> F-CClF <sub>2</sub>	0	783.7	
d-1,3,3-trimethylnorcamphor	C <sub>10</sub> H <sub>16</sub> O	25	1320	0.22
Trinitrotoluene	C <sub>7</sub> H <sub>5</sub> (NO <sub>2</sub> ) <sub>3</sub>	81	1610	
Turpentine		25	1255	1.4
Unisis 800		25	1346	
Water, distilled	H <sub>2</sub> O	20	1482	1.00
Water, heavy	D <sub>2</sub> O	20	1388	1.129
Water, sea		20	1520	1.00
Wood alcohol	CH <sub>4</sub> O	25	1076	0.695
m-xylene	C <sub>8</sub> H <sub>10</sub>	20	1343	0.749 (15°C)
o-xylene	C <sub>8</sub> H <sub>10</sub>	25	1331.5	0.903 (20°C)
p-xylene	C <sub>8</sub> H <sub>10</sub>	20	1334	0.662
Xylene hexafluoride	C <sub>8</sub> H <sub>4</sub> F <sub>6</sub>	25	879	0.613

---

## **Fuji Electric Co.,Ltd.**

### **Head office**

11-2 Osaki 1-chome, Sinagawa-ku, Tokyo,141-0032 Japan  
Phone:81-3-5435-7111  
[http://www.fujielectric.co.jp/eng/sg/KEISOKU /welcome.htm](http://www.fujielectric.co.jp/eng/sg/KEISOKU/welcome.htm)

## **Fuji Electric Instruments Co.,Ltd.**

### **Sales Div.**

**International Sales Dept.**  
No.1 , Fuji-machi, Hino-city, Tokyo,191-8502 Japan  
Phone:81-42-585-6201,6202  
Fax:81-42-585-6187,6189