

M/s. ELITE INDUSTRIES

K-1/249, GIDC 1, Shankar Tekri Udyognagar,
JAMNAGAR - 361 004 [Gujarat - INDIA]



Mkt. & Sales Head : Mr. Paras Mehta : +91 98250 61140

Other Contact : Mr. Gunjan Mehta : +91 99790 36524, Mr. Ashok Mehta : +91 98795 00558

Office : +91 288 2565000



<https://www.google.co.in/maps/place/Elite+Industries/@22.457722,70.050337,17z/data=!3m1!4b1!4m2!3m1!1s0x39576ab96aa69ee3:0x3c3465a0657ec78d>



<http://www.eliteindustries.co.in/>



replyelite@gmail.com



<https://www.facebook.com/eliteindustries.jamnagar/photos>



<https://www.plus.google.com/u/0/photos/112905963829783592836/albums>



<https://twitter.com/EliteJamnagar/>

No.	Title	Page
01	BRASS HINGES [45 PRODUCTS]	004
02	BRASS TOWER BOLT [40 PRODUCTS]	050
03	BRASS BABY LATCH [11 PRODUCTS]	091

BRASS HINGES

01.01 - HINGES [MINI BUTT TYPE]

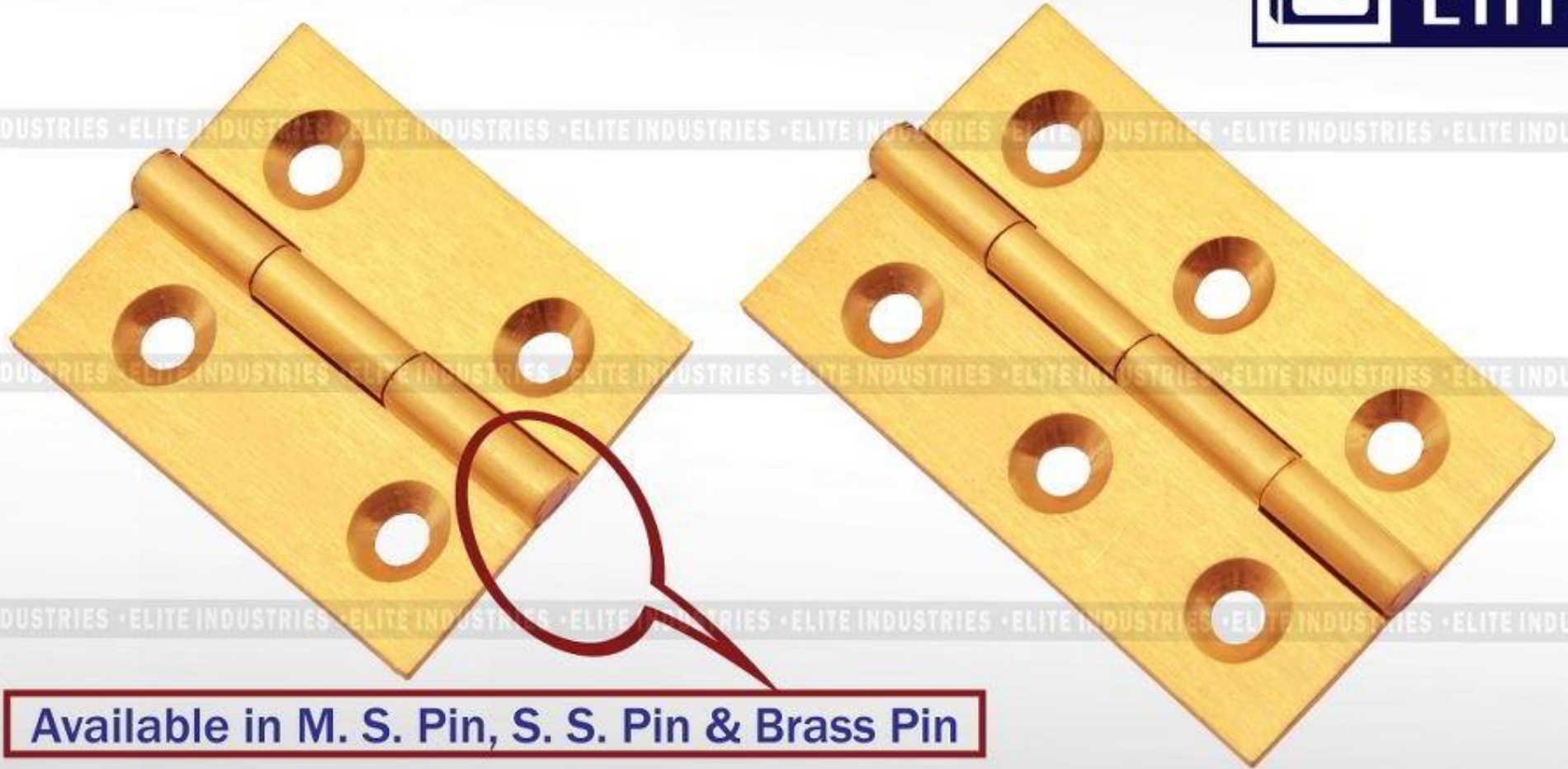

Available in M. S. Pin, S. S. Pin & Brass Pin

01.02 - HINGES [CUTT TYPE]



01.03 - HINGES [HEAVY CUTT TYPE]



01.04 - HINGES [BUTT TYPE]



01.05 - HINGES [HEAVY BUTT TYPE]



01.06 - HINGES [PREMIUM EXPORT BUTT TYPE]



Copper
Pin



SS 304 Pin



Hidden Pin



Brass Pin

01.06 - HINGES [BUTT WITH FANCY FINIALS TYPE]



ELITE INDUSTRIES · ELITE INDUSTRIES · ELITE INDUSTRIES · ELITE INDUSTRIES · ELITE INDUSTRIES · ELITE INDUSTRIES · ELITE INDUSTRIES · ELITE INDUSTRIES

ELITE INDUSTRIES · ELITE INDUSTRIES · ELITE INDUSTRIES · ELITE INDUSTRIES · ELITE INDUSTRIES · ELITE INDUSTRIES · ELITE INDUSTRIES · ELITE INDUSTRIES

ELITE INDUSTRIES · ELITE INDUSTRIES · ELITE INDUSTRIES · ELITE INDUSTRIES · ELITE INDUSTRIES · ELITE INDUSTRIES · ELITE INDUSTRIES · ELITE INDUSTRIES

ELITE INDUSTRIES · ELITE INDUSTRIES · ELITE INDUSTRIES · ELITE INDUSTRIES · ELITE INDUSTRIES · ELITE INDUSTRIES · ELITE INDUSTRIES · ELITE INDUSTRIES



Available in Various Finials

Finials



01.08 - HINGES [BUTT WITH SS LOCKING WASHER TYPE]



SS Lock Washer



02.01 - HINGES [MINI CUTT RAILWAY TYPE]



02.02 - HINGES [MINI RAILWAY TYPE]



<http://www.eliteindustries.co.in>

replyelite@gmail.com

02.03 - HINGES [MEDIUM RAILWAY TYPE]



Available upto :
12" Long,
6" Width
6MM Thickness

<http://www.eliteindustries.co.in>

replyelite@gmail.com

02.04 - HINGES [PREMIUM EXPORT RAILWAY TYPE]



Available upto :
12" Long,
6" Width
6MM Thickness

<http://www.eliteindustries.co.in>

replyelite@gmail.com

02.05 - HINGES [LOCKING SS WASHER TYPE]



ELITE INDUSTRIES · ELITE INDUSTRIES · ELITE INDUSTRIES · ELITE INDUSTRIES · ELITE INDUSTRIES · ELITE INDUSTRIES · ELITE INDUSTRIES · ELITE INDUSTRIES

A red callout bubble with a pointer pointing to the first stainless steel lock washer on the hinge pin.

SS Lock Washer

Available upto :
3" to 12" Long,
3" Width
5MM Thickness

<http://www.eliteindustries.co.in>

replyelite@gmail.com

02.06 - HINGES [PREMIUM LOCKING SS WASHER TYPE]



SS Lock Washer

Available upto :
3" to 12" Long,
3" Width
5MM Thickness

02.07 - HINGES [SOFT MOVEMENT RAILWAY TYPE]



Available upto :
12" Long,
6" Width
6MM Thickness



Finials



03.01 - HINGES [MINI BEARING TYPE]



<http://www.eliteindustries.co.in>

replyelite@gmail.com

03.02 - HINGES [4 BEARING TYPE]



Available upto :
12" Long,
6" Width
6MM Thickness

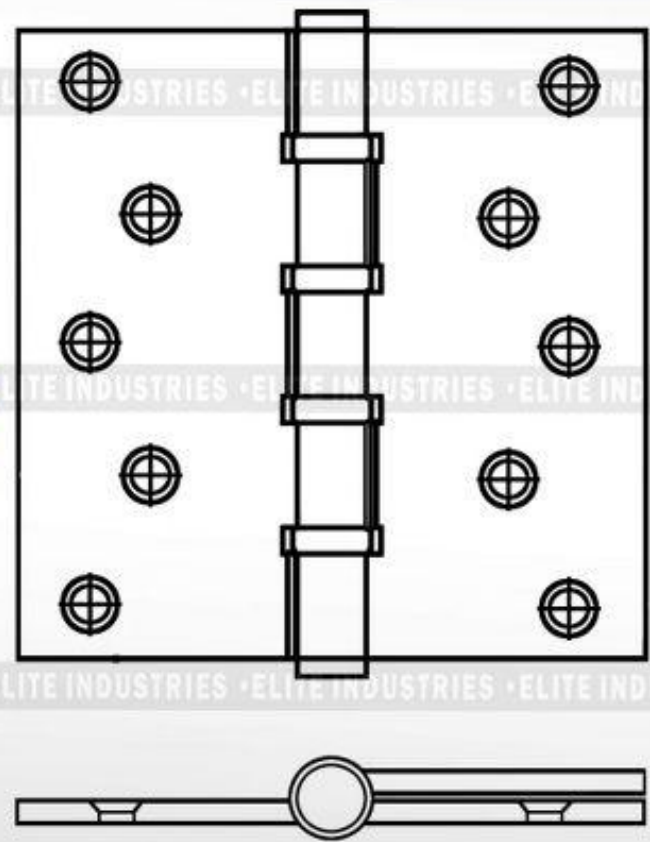

03.03 - HINGES [4 BEARING FANCY FINIALS TYPE]



Finials



Available upto :
12" Long,
6" Width
6MM Thickness

03.04 - HINGES [PREMIUM EXPORT 4 BEARING TYPE]



Available upto :
12" Long,
6" Width
6MM Thickness

<http://www.eliteindustries.co.in>

replyelite@gmail.com

03.05 - HINGES [PREMIUM EXPORT 4 BEARING FANCY FINIALS TYPE]



Available upto :
12" Long,
6" Width
6MM Thickness



Finials



03.06 - HINGES [CRANKED BEARING TYPE]



<http://www.eliteindustries.co.in>

replyelite@gmail.com

03.07 - HINGES [4 BEARING SECURITY TYPE]



Finials



04 - HINGES [PARLAMENT TYPE]



05.01 - HINGES [CRANKED 'L' TYPE]



05.02 - HINGES [CRANKED ROUND 'W' TYPE]

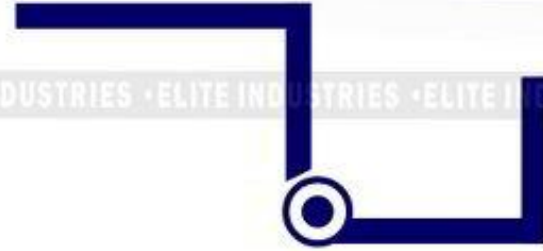

05.03 - HINGES [CRANKED ROUND 'W' WITH 90° LOCKING TYPE]



05.04 - HINGES [CRANKED PREMIUM 'W' TYPE]



05.05 - HINGES [CRANKED 'Z' TYPE]



05.06 - HINGES [CRANKED 'L/R' TYPE]



05.07 - HINGES [CRANKED 'U' TYPE]



05.10 - HINGES [CRANKED FINIALS TYPE]



ELITE INDUSTRIES · ELITE INDUSTRIES · ELITE INDUSTRIES · ELITE INDUSTRIES · ELITE INDUSTRIES · ELITE INDUSTRIES · ELITE INDUSTRIES · ELITE INDUSTRIES · ELITE INDUSTRIES

ELITE INDUSTRIES · ELITE INDUSTRIES · ELITE INDUSTRIES · ELITE INDUSTRIES · ELITE INDUSTRIES · ELITE INDUSTRIES · ELITE INDUSTRIES · ELITE INDUSTRIES · ELITE INDUSTRIES

Finials



ELITE INDUSTRIES · ELITE INDUSTRIES · ELITE INDUSTRIES · ELITE INDUSTRIES · ELITE INDUSTRIES · ELITE INDUSTRIES · ELITE INDUSTRIES · ELITE INDUSTRIES · ELITE INDUSTRIES

05.11 - HINGES [CRANKED 'L' WITH 90° LOCKING TYPE]



90° Locking System...

05.12 - HINGES [CRANKED ROUND 'W' WITH 90° LOCKING TYPE]



90° Locking System...

05.13 - HINGES [CRANKED SQUARE 'W' WITH 90° LOCKING TYPE]



90° Locking System...

05.14 - HINGES [CRANKED PREMIUM 'W' WITH 90° LOCKING TYPE]



90° Locking System...

05.15 - HINGES [CRANKED 'Z' WITH 90° LOCKING TYPE]



90° Locking System...

06.01 - HINGES [SINGLE ACTION SPRING TYPE]



06.02 - HINGES [DOUBLE ACTION SPRING TYPE]



07.01 - HINGES [CENTRE SADA PIVOT TYPE]

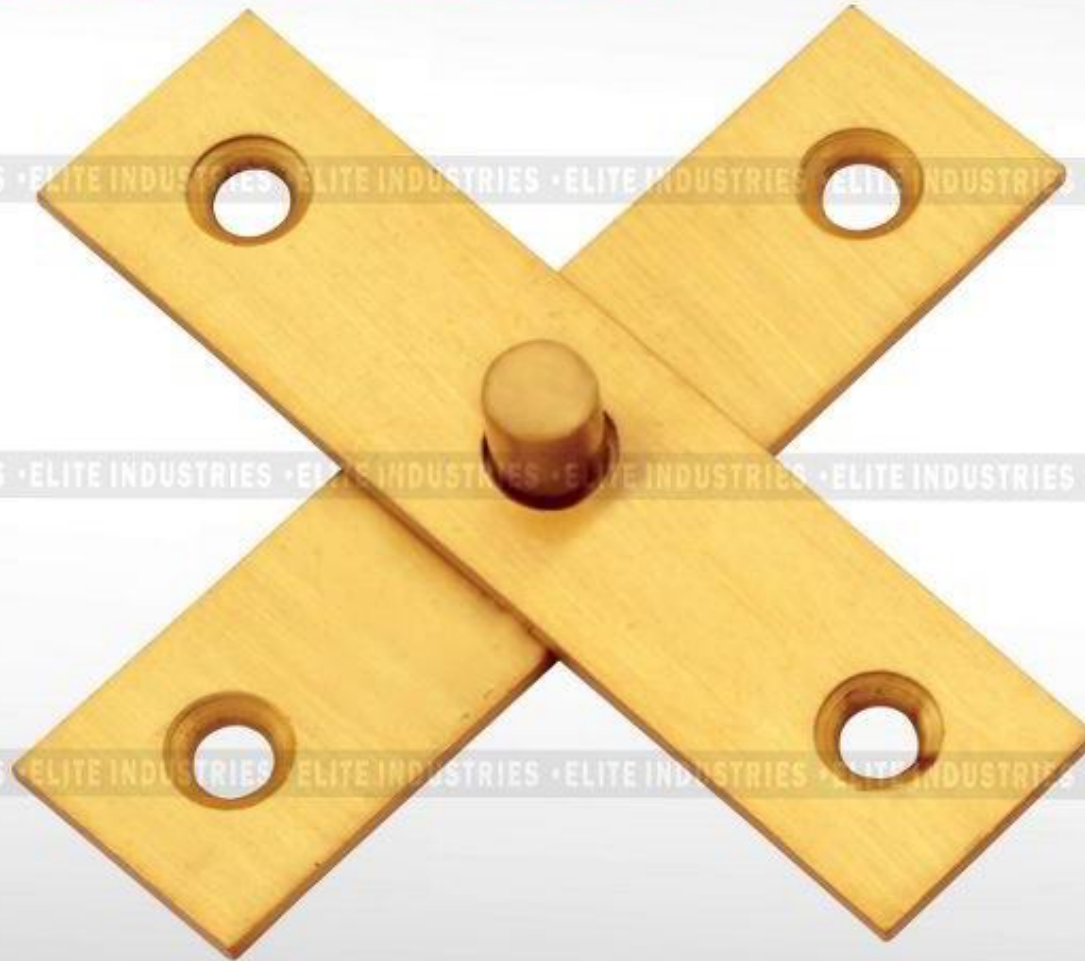

07.02 - HINGES [SIDE SADA PIVOT TYPE]



07.06 - HINGES [CENTRE BEARING PIVOT TYPE]



07.07 - HINGES [SIDE BEARING PIVOT TYPE]



07.08 - HINGES [HEAVY BEARING PIVOT TYPE]



14.01 - HINGES [REFLEX - LIFT OFF TYPE]



14.02 - HINGES [LOCK TYPE]



**BRASS
TOWER BOLT**

15.03 - TOWER BOLT [9MM REGULAR TYPE]



Available upto 2 Feet Long Series

<http://www.eliteindustries.co.in>

replyelite@gmail.com

15.04 - TOWER BOLT [10MM REGULAR TYPE]



Available upto 2 Feet Long Series

<http://www.eliteindustries.co.in>

replyelite@gmail.com

15.05 - TOWER BOLT [12MM REGULAR TYPE]



Available upto 4 Feet Long Series

<http://www.eliteindustries.co.in>

replyelite@gmail.com

15.06 - TOWER BOLT [PREMIUM 12MM REGULAR TYPE]



Available upto 8 Feet Long Series

<http://www.eliteindustries.co.in>

replyelite@gmail.com

15.07 - TOWER BOLT [9MM SQUARE TYPE]

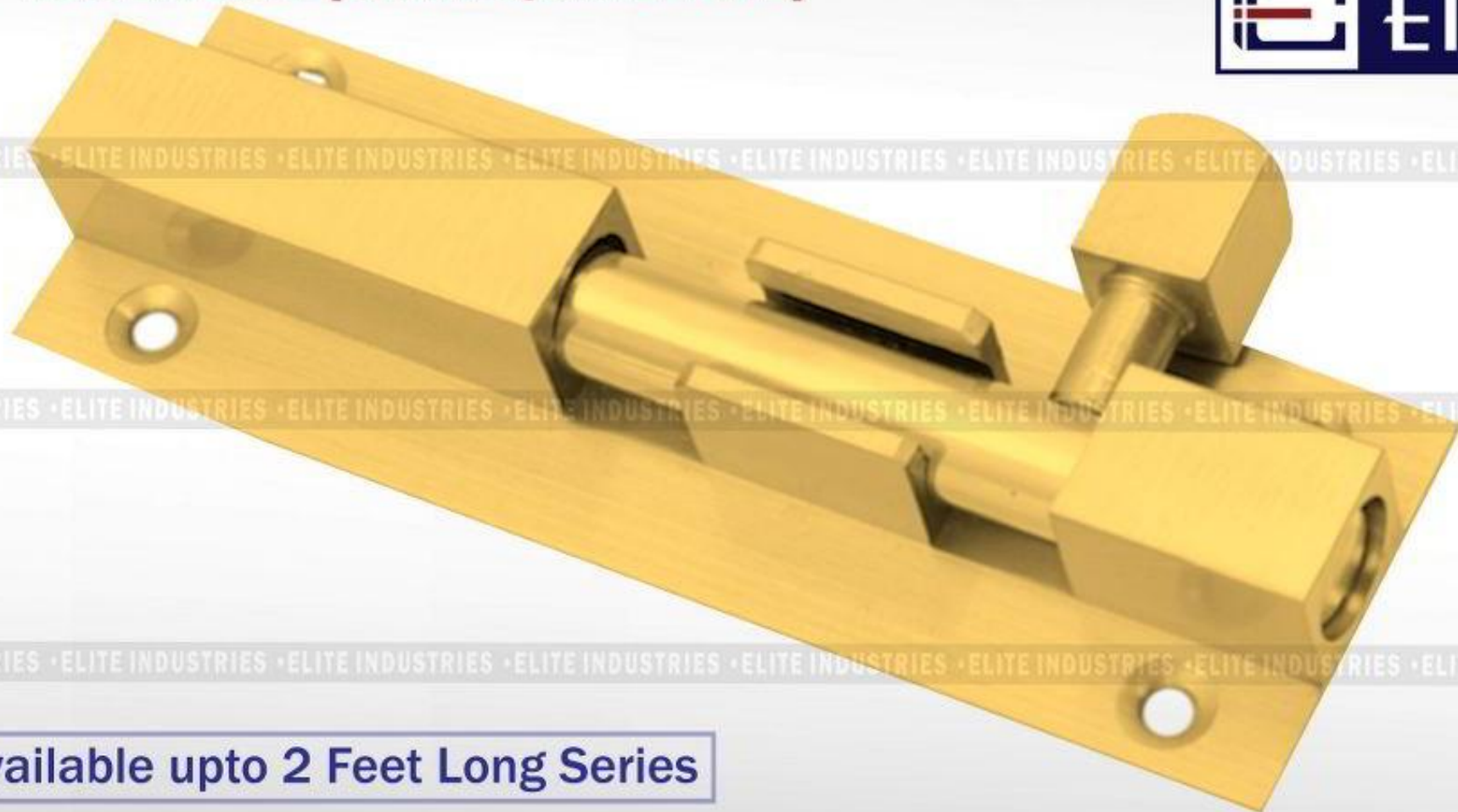

Available upto 2 Feet Long Series

15.08 - TOWER BOLT [PREMIUM 16MM REGULAR TYPE]



ELITE INDUSTRIES · ELITE INDUSTRIES · ELITE INDUSTRIES · ELITE INDUSTRIES · ELITE INDUSTRIES · ELITE INDUSTRIES · ELITE INDUSTRIES · ELITE INDUSTRIES

ELITE INDUSTRIES · ELITE INDUSTRIES · ELITE INDUSTRIES · ELITE INDUSTRIES · ELITE INDUSTRIES · ELITE INDUSTRIES · ELITE INDUSTRIES · ELITE INDUSTRIES

ELITE INDUSTRIES · ELITE INDUSTRIES · ELITE INDUSTRIES · ELITE INDUSTRIES · ELITE INDUSTRIES · ELITE INDUSTRIES · ELITE INDUSTRIES · ELITE INDUSTRIES

Available upto 8 Feet Long Series

<http://www.eliteindustries.co.in>

replyelite@gmail.com

16 - TOWER BOLT [9MM & 12MM HEX TYPE]



Available upto 2 Feet Long Series

<http://www.eliteindustries.co.in>

replyelite@gmail.com

17 - TOWER BOLT [9MM & 12MM VX TYPE]



Available upto 2 Feet Long Series

<http://www.eliteindustries.co.in>

replyelite@gmail.com

18 - TOWER BOLT [ARCHITECTURAL FLUSH TYPE]



Available upto 2 Feet Long Series

<http://www.eliteindustries.co.in>

replyelite@gmail.com

19 - TOWER BOLT [ARCHITECTURAL LOCKING FLUSH TYPE]



Available upto 2 Feet Long Series

<http://www.eliteindustries.co.in>

replyelite@gmail.com

20 - TOWER BOLT [ARCHITECTURAL SLIDING FLUSH TYPE]



Available upto 2 Feet Long Series

<http://www.eliteindustries.co.in>

replyelite@gmail.com

21.01 - TOWER BOLT [ARCHITECTURAL CAMBOLT TYPE]



21.02 - TOWER BOLT [ARCHITECTURAL CAMBOLT PREMIUM TYPE]



21.03 - TOWER BOLT [ARCHITECTURAL CAMBOLT ONE PCS.TYPE]



22.01 - CENTRAL LOCK TOWER BOLT [PYRAMID / TRIANGLE TYPE]



22.02 - CENTRAL LOCK TOWER BOLT [FLOWER TYPE]

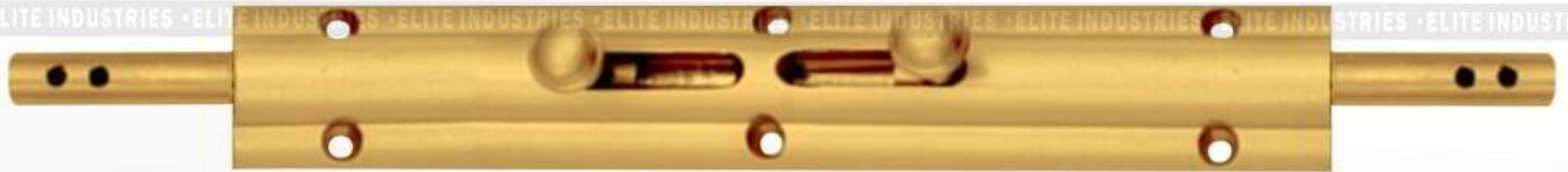

22.03 - CENTRAL LOCK TOWER BOLT [CAPSULE TYPE]



23.01 - TOWER BOLT [CAPSULE TYPE]



Available upto 2 Feet Long Series

<http://www.eliteindustries.co.in>

replyelite@gmail.com

23.02 - TOWER BOLT [ROYAL TYPE]



Available upto 2 Feet Long Series

<http://www.eliteindustries.co.in>

replyelite@gmail.com

23.03 - TOWER BOLT [BEDA TYPE]



Available upto 2 Feet Long Series

<http://www.eliteindustries.co.in>

replyelite@gmail.com

23.04 - TOWER BOLT [NAKED TYPE]



Available upto 2 Feet Long Series

<http://www.eliteindustries.co.in>

replyelite@gmail.com

23.05 - TOWER BOLT [MARBLE TYPE]



Available upto 2 Feet Long Series

<http://www.eliteindustries.co.in>

replyelite@gmail.com

23.06 - TOWER BOLT [CONCEALED TYPE]



Available upto 2 Feet Long Series

23.07 - TOWER BOLT [XYLO TYPE]



Available upto 2 Feet Long Series

<http://www.eliteindustries.co.in>

replyelite@gmail.com

23.08 - TOWER BOLT [MANGO TYPE]



Available upto 2 Feet Long Series

<http://www.eliteindustries.co.in>

replyelite@gmail.com

23.09 - TOWER BOLT [FLOWER TYPE]



Available upto 2 Feet Long Series

<http://www.eliteindustries.co.in>

replyelite@gmail.com

23.10 - TOWER BOLT [VITRA TYPE]



Available upto 2 Feet Long Series

<http://www.eliteindustries.co.in>

replyelite@gmail.com

23.11 - TOWER BOLT [PYRAMID TYPE]



Available upto 2 Feet Long Series

<http://www.eliteindustries.co.in>

replyelite@gmail.com

23.12 - TOWER BOLT [RAJWADI TYPE]



Available upto 2 Feet Long Series

<http://www.eliteindustries.co.in>

replyelite@gmail.com

23.13 - TOWER BOLT [RECTANGLE TYPE]



Available upto 2 Feet Long Series

<http://www.eliteindustries.co.in>

replyelite@gmail.com

23.14 - TOWER BOLT [ROUND TYPE]



Available upto 2 Feet Long Series

<http://www.eliteindustries.co.in>

replyelite@gmail.com

23.15 - TOWER BOLT [TRIANGLE TYPE]



Available upto 2 Feet Long Series

<http://www.eliteindustries.co.in>

replyelite@gmail.com

23.16 - TOWER BOLT [SQUARE TYPE]



Available upto 2 Feet Long Series

<http://www.eliteindustries.co.in>

replyelite@gmail.com

23.17 - TOWER BOLT [OVAL TYPE]



Available upto 2 Feet Long Series

<http://www.eliteindustries.co.in>

replyelite@gmail.com

23.18 - TOWER BOLT [CROWN TYPE]



Available upto 2 Feet Long Series

<http://www.eliteindustries.co.in>

replyelite@gmail.com

23.19 - TOWER BOLT [ZEN TYPE]



Available upto 2 Feet Long Series

<http://www.eliteindustries.co.in>

replyelite@gmail.com

23.20 - TOWER BOLT [HALF ROUND TYPE]



Available upto 2 Feet Long Series

<http://www.eliteindustries.co.in>

replyelite@gmail.com

23.21 - TOWER BOLT [QUEEN TYPE]



Available upto 2 Feet Long Series

<http://www.eliteindustries.co.in>

replyelite@gmail.com

23.22 - TOWER BOLT [NEW XYLO TYPE]

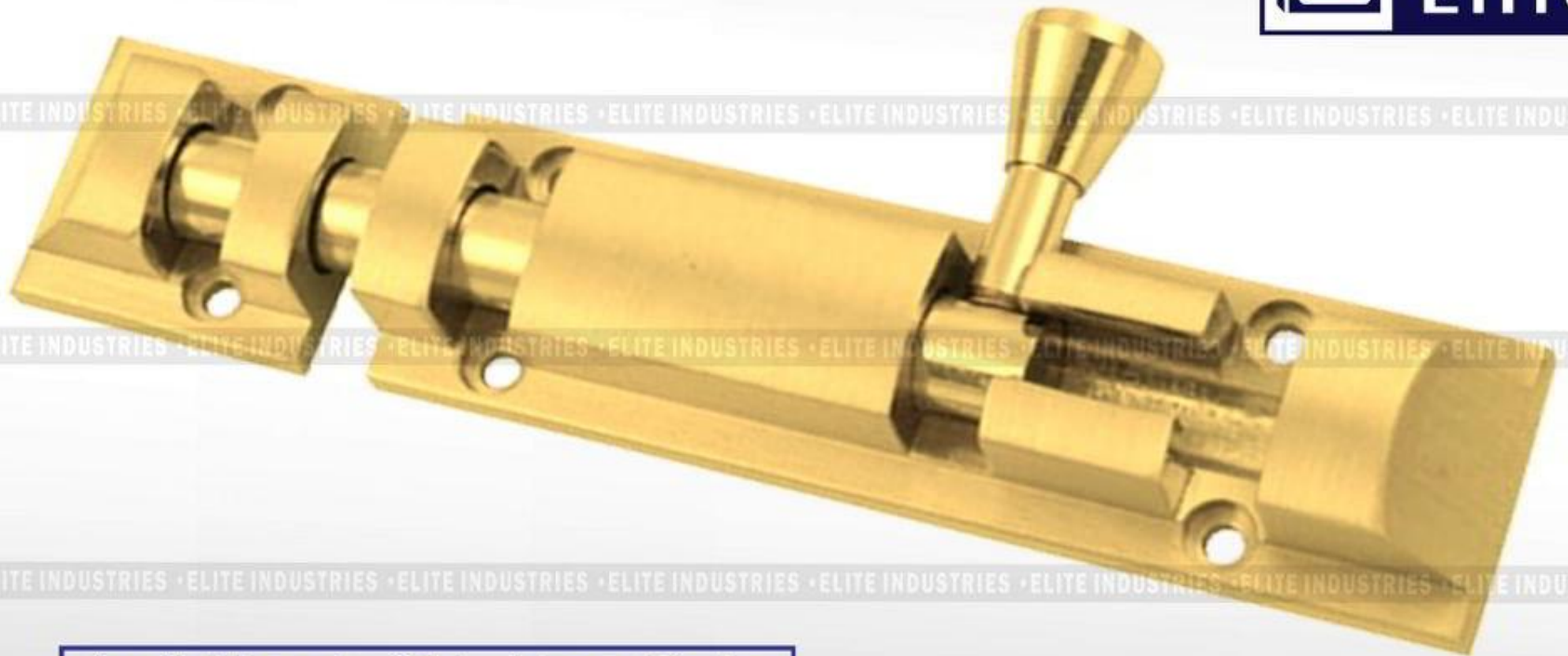

Available upto 2 Feet Long Series

<http://www.eliteindustries.co.in>

replyelite@gmail.com

23.23 - TOWER BOLT [FLUSH PATTI TYPE]



Available upto 2 Feet Long Series

<http://www.eliteindustries.co.in>

replyelite@gmail.com

BRASS

BABY LATCH

24.01 - BABY LATCH [CAPSULE TYPE]



<http://www.eliteindustries.co.in>

replyelite@gmail.com

24.02 - BABY LATCH [ROYAL TYPE]



<http://www.eliteindustries.co.in>

replyelite@gmail.com

24.03 - BABY LATCH [ZEN TYPE]



24.04 - BABY LATCH [HALF ROUND TYPE]



24.05 - BABY LATCH [DELUXE TYPE]



<http://www.eliteindustries.co.in>

replyelite@gmail.com

24.06 - BABY LATCH [PREMIUM SQUARE TYPE]

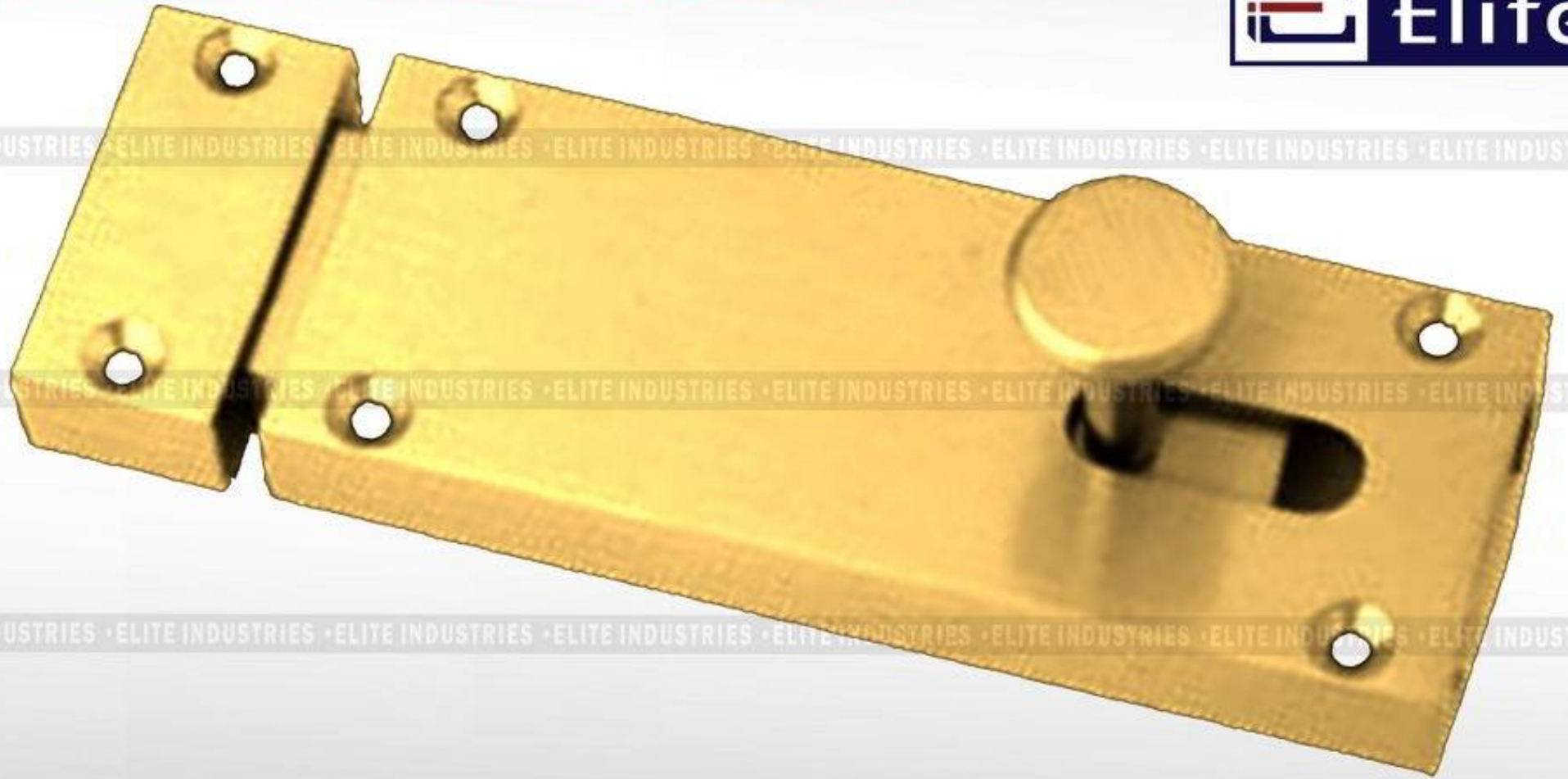

24.07 - BABY LATCH [LOCKING SQUARE TYPE]



24.08 - BABY LATCH ['U' TYPE]



24.09 - BABY LATCH [XYLO TYPE]



<http://www.eliteindustries.co.in>

replyelite@gmail.com

24.10 - BABY LATCH [FLOWER TYPE]



24.11 - BABY LATCH [ROUND TYPE]





M/s. ELITE INDUSTRIES

K-1/249, GIDC 1, Shankar Tekri Udyognagar,
JAMNAGAR - 361 004 [Gujarat - INDIA]

Thank
You